

Copyright Warning & Restrictions

The copyright law of the United States (Title 17, United States Code) governs the making of photocopies or other reproductions of copyrighted material.

Under certain conditions specified in the law, libraries and archives are authorized to furnish a photocopy or other reproduction. One of these specified conditions is that the photocopy or reproduction is not to be “used for any purpose other than private study, scholarship, or research.” If a user makes a request for, or later uses, a photocopy or reproduction for purposes in excess of “fair use” that user may be liable for copyright infringement,

This institution reserves the right to refuse to accept a copying order if, in its judgment, fulfillment of the order would involve violation of copyright law.

Please Note: The author retains the copyright while the New Jersey Institute of Technology reserves the right to distribute this thesis or dissertation

Printing note: If you do not wish to print this page, then select “Pages from: first page # to: last page #” on the print dialog screen

The Van Houten library has removed some of the personal information and all signatures from the approval page and biographical sketches of theses and dissertations in order to protect the identity of NJIT graduates and faculty.

ABSTRACT

EXPERIMENTAL AND COMPUTATIONAL STUDIES OF FUNCTIONALIZED CARBON NANOTUBES FOR USE IN ENERGY STORAGE DEVICES AND MEMBRANES

by
Emine S. Karaman

Electrolytes with good interfacial stability are a crucial component of any electrochemical device. The development of novel gel polymer electrolytes (GEs) with good interface stability and better manufacturability is important for the development of the next generation electrochemical devices. Gel electrolytes are hybrid electrolyte materials, combining benefits of both liquid and solid systems. Compared with liquid and solid electrolytes, GEs open new design opportunities and do not require rigorous encapsulation methods. In this dissertation, studies on functionalized carbon nanotubes (fCNTs) and graphene oxide (GO) doped polyvinyl alcohol (PVA) based gel electrolytes (GEs) are reported. The ionic conductivity and mechanical strength of fCNT doped gel electrolyte (fCNTGE) is significantly improved, when compared to pure GE and graphene oxide doped gel electrolyte (GOGE). The ionic conductivity is significantly improved by introducing fCNTs into the PVA gel and reaches $6.9 \times 10^{-2} \text{ S cm}^{-1}$, revealing that the diffusion and transport of ions into electrolyte are much better than the GE and GOGE. A significant enhancement in the gel mechanical properties is observed with Young's modulus ($E = 2.3$) and tensile strength (22.3 kPa) of fCNTGE. Furthermore, the composite Zn–Ag₂O batteries are made and tested using the fCNTGE, GE, and GOGE in three dimensional (3D) -printed battery casings.

However, questions remain about the origin of the property enhancement and the interactions between components of GEs. Density functional theory (DFT) calculations are employed to analyze the interactions between fCNT, PVA, and Zn ions. CNTs with increasing numbers of carboxyl (-COOH) functional groups and PVA chains with varying lengths are studied. Increasing the number of -COOH on the CNTs enhances the adsorption energies (E_{ads}) of PVA, and E_{ads} also increase as the number of monomers increase. Strong fCNT-PVA interactions contribute to the enhanced mechanical strength and thermal stability, while the enhanced ionic conductivity is partly due to weak Zn adsorption.

Computational modelling is used to understand how fCNT displays better performance in membrane separation and investigate if the same trend could be seen for different pollutants as well. The nature of the interactions between the pollutants and raw and functionalized CNTs are studied on the atomic level by using DFT calculations. By determining the adsorption energies, DFT calculations theoretically confirm that pollutants interact more strongly with fCNTs than unfunctionalized CNTs, likely partly contributing to the observed some properties such as mass transfer coefficient, selectivity, and flux. It is demonstrated that this is due to enhanced charge transfer between the CNT and pollutants as the number of functional groups increases. Trends in the HOMO-LUMO gap and how they are affected by the functionalization of the CNT are also described. These calculations allow for better understanding of the influence of CNT functionalization on the properties of membranes.

**EXPERIMENTAL AND COMPUTATIONAL STUDIES OF FUNCTIONALIZED
CARBON NANOTUBES FOR USE IN ENERGY STORAGE DEVICES AND
MEMBRANES**

by
Emine S. Karaman

**A Dissertation
Submitted to the Faculty of
New Jersey Institute of Technology
in Partial Fulfillment of the Requirements for the Degree of
Doctor of Philosophy in Materials Science and Engineering
Materials Science Option**

Interdisciplinary Program in Materials Science and Engineering

December 2021

Copyright © 2021 by Emine S. Karaman

ALL RIGHTS RESERVED

APPROVAL PAGE

**EXPERIMENTAL AND COMPUTATIONAL STUDIES OF FUNCTIONALIZED
CARBON NANOTUBE FOR USE IN ENERGY STORAGE DEVICES AND
MEMBRANES**

Emine S. Karaman

Dr. Somenath Mitra, Dissertation Advisor Date
Distinguished Professor of Chemistry and Environmental Science, NJIT

Dr. Joshua Young, Dissertation Co-Advisor Date
Assistant Professor of Chemical and Materials Engineering, NJIT

Dr. Trevor A. Tyson, Committee Member Date
Distinguished Professor of Physics, NJIT

Dr. Nuggehalli M. Ravindra, Committee Member Date
Professor of Physics, NJIT

Dr. Keun Hyuk Ahn, Committee Member Date
Associate Professor of Physics, NJIT

BIOGRAPHICAL SKETCH

Author: Emine S Karaman
Degree: Doctor of Philosophy
Date: December 2021

Undergraduate and Graduate Education:

- Doctor of Philosophy in Materials Science and Engineering, New Jersey Institute of Technology, Newark, NJ, 2021
- Master of Science in Biomedical Engineering, New Jersey Institute of Technology, Newark, NJ, 2015
- Master of Science in Nuclear Physics, Istanbul Technical University, Istanbul, Turkey, 2002
- Bachelor of Science in Physics, Anatolian University, Turkey, 1998

Major: Materials Science and Engineering

Presentations and Publications:

Emine S. Karaman, S. Mitra, and J. Young, Computational Investigation of Enhanced Properties in Functionalized Carbon Nanotube Doped Polyvinyl Alcohol Gel Electrolyte Systems. (Physical Chemistry Chemical Physics, 2021)

Emine S. Karaman, Zhiqian Wang, Kun Chen, Zain Siddiqui, YuHsuan Cheng, Sagnik Basuray, Vivek Kumar, Somenath Mitra. Functionalized Carbon Nanotube Doped Gel Electrolytes with Enhanced Mechanical and Electrical Properties for Battery Applications. (Materials Chemistry and Physics, 2021)

Emine S. Karaman, Zhiqian Wang, Giuseppe Di Benedetto, James L. Zunino, III, Xianyang Meng and Somenath Mitra. Fabrication of Supercapacitors and Flexible Electrodes Using Biosilica from Cultured Diatoms. (Materials Today Energy, 2019)

Emine S. Karaman, Zhiqian Wang and Somenath Mitra. Biosilica From Cultured Diatoms and Its Composite with Iron Oxide for Supercapacitor Electrodes. (American Chemical Society National Meeting, Orlando 2019)

Emine S. Karaman, Zhiqian Wang, Giuseppe Di Benedetto, James L. Zunino, III, and Somenath Mitra. Bio-Silica from Cultured Diatoms for Energy Storage - Flexible Electrodes and Supercapacitors. Podium. (Power Sources Conference, 2018)

Zhiqian Wang, Emine S. Karaman and Somenath Mitra. Development of High-capacity Flexible Sodium Manganese Periodate Batteries with Dual Polymer Electrolytes. (Materials Today Communication, 2020)



This thesis is wholeheartedly dedicated to my beloved dad and my wonderful family who have been with me every step of the way through good times and bad. Thank you for all your endless love, sacrifices, prayers, and support.

ACKNOWLEDGEMENT

First and foremost, praises and thanks to the Almighty GOD for the guidance, strength, presence of mind and knowledge for everyday life.

I would like to express my deep and sincere gratitude to my research advisor, Professor Somenath Mitra, who has believed in me from the beginning to the end. He offered me the most important projects, and he has been my source of inspiration, gave me strength even when I thought of giving up.

I would like to give special thanks to my co-advisor, Dr. Joshua Young, for his patience, motivation, and immense knowledge. I could not have imagined having a better co-advisor and mentor for my research.

I wish to thank my committee members: Dr. Trevor A. Tyson, Dr. Nuggehalli M. Ravindra, and Dr. Ken Ahn for providing me with all the necessary facilities. This journey was started with a single question asked by Dr. Trevor A. Tyson when we met on campus after the graduation with my master's degree. His encouragement means a lot to me. I also owe a special thanks to Dr. Nuggehalli M. Ravindra who accepted me to the program. It is my privilege to thank Dr. Oktay Gokce for his kind help, constant encouragement, and co-operation throughout my research period. Millions of thanks go to Dr. Zhiqian Wang for his friendship, mentoring, and close supervision.

It is a pleasure to thank my husband, Erhan who believes in richness of learning and my family who made me keen on learning. I also express my deep thanks to my sisters and brother, Necla, Nuray, Nurdan and Ali, and sweet nieces and nephews Burcu, Kubra, Abdullah, Aziz, Isra, Safa, Fatih and Semih for their support and valuable advice.

TABLE OF CONTENTS

Chapter		Page
1	INTRODUCTION.....	1
1.1	Objective.....	1
1.2	Background Information.....	2
	1.2.1 Introduction to Gel Electrolyte Systems.....	2
	1.2.2 Literature Review of Gel Electrolyte Systems.....	5
	1.2.3 Functionalized Carbon Nanotube in Gel Electrolyte Systems.....	9
	1.2.4 Electrochemical Impedance Spectroscopy.....	12
	1.2.5 Transference Number and Electrochemical Stability Window.....	14
	1.2.6 Introduction to Density Functional Theory.....	13
	1.2.7 Conclusion.....	24
2	FUNCTIONALIZED CARBON NANOTUBE DOPED GEL ELECTROLYTES WITH ENHANCED MECHANICAL AND ELECTRICAL PROPERTIES FOR BATTERY APPLICATION.....	26
2.1	Introduction	26
2.2	Experimental Description	27
	2.2.1 Preparation of Polymer Gel electrolytes (GE), fCNT and Graphene oxide (GO) Doped Polymer Gel Electrolytes	27
	2.2.2 Preparation of Electrodes	28
	2.2.3 Materials and Treatment.....	28
	2.2.4 Characterizations.....	29

TABLE OF CONTENTS
(Continued)

Chapter		Page
2.3	Results and Discussion	30
2.3.1	Structural Characterization of GE, fCNTGE, and GOG E	30
2.3.2	Mechanical Properties of GE, fCNTGE, and GOG E	39
2.3.3	Electrical Properties of the GE, fCNTGE, and GOG E	41
2.3.4	Transference Number and Electrochemical Stability Window Measurements	44
2.3.5	Galvanostatic Charge-Discharge (GCD) Analysis of GE, fCNTGE, and GOG E	47
2.4	Conclusion.....	48
3	COMPUTATIONAL INVESTIGATION OF ENHANCED PROPERTIES IN FUNCTIONALIZED CARBON NANOTUBE DOPED POLYVINYL ALCOHOL GEL ELECTROLYTE SYSTEMS	50
3.1	Introduction	50
3.2	Computational Method	52
3.3	Results and Discussion.....	55
3.3.1	PVA Interaction with Pristine and Functionalized CNTs	55
3.3.2	Zn Ion Interaction with Pristine and Functionalized CNT-(PVA) _n Complexes	62
3.3.3	Discussion	64

TABLE OF CONTENTS
(Continued)

Chapter		Page
3.4	Conclusion	66
4	COMPUTATIONAL STUDY OF ADSORPTION OF WATER POLLUTANTS ON A FUNCTIONALIZED CARBON NANOTUBE-BASED MEMBRANE	
4.1	Introduction	68
4.2	Methods.....	70
4.3	Results and Discussion.....	73
	4.3.1. Pollutant Interactions with Functionalized CNT in Gas Phase	73
	4.3.2. Pollutant Interactions with Functionalized CNT in Aqueous Phase	78
	4.3.3. Charge Transfer in the Pollutant-Functionalized CNT Systems.....	79
	4.3.4. HUMO-LUMO.....	82
4.4	Conclusion.....	85
	Appendix A	86
	Appendix B.....	94
	References	438

LIST OF TABLES

Table	Page
2.1 Ionic Conductivity of Gel Electrolytes with Different Degree of Carboxylation CNTs	30
2.2 Calculated Thermal and Mechanical Properties, Ionic Conductivity, Transference Numbers, and Specific Capacity & Energy	34
3.1 Adsorption Energy of PVA and Charge Transfer to PVA and Zn in Each CNT-PVA-Zn Complex	58
3.2 The Energy of the HOMO (E_{HOMO}), LUMO (E_{LUMO}), and HOMO-LUMO gap (E_g) in Units of eV	61
3.3 Adsorption energy (ΔE_{ads} , units of eV) of PVA and charge transfer (ΔQ_e , units of electrons, e) to PVA with Zn and the energy of the HOMO (E_{HOMO}), LUMO (E_{LUMO}), and HOMO-LUMO gap (E_g) in units of eV in each CNT-PVA-Zn complex.....	63
4.1 Adsorption (ΔE_{ads}) and Solvation Energies (ΔE_{sol}) (units of eV) of Samples and Charge Transfer (ΔQ_e), (units of electrons).....	76
4.2 The energy of the HOMO (E_{HOMO}), LUMO (E_{LUMO}), and HOMO-LUMO gap (E_g) in units of eV.....	83

LIST OF FIGURES

Figure	Page
1.1 Schematic illustration of gel through chemically cross-Linked or physically cross-linked.....	3
1.2 Ion conducting mechanism in the polymer electrolyte.....	4
1.3 Functionalization possibilities for SWNTs: a) Defect-group functionalization, b) Covalent sidewall functionalization, c) Non-covalent exohedral functionalization with surfactants, d) Non-covalent exohedral functionalization with polymers.....	11
1.4 (a) Schematic drawing of GE sandwiched between two blocking electrodes. (b) Equivalent circuit (model) of GE sandwiched between two blocking electrodes.....	13
1.5 Typical AC impedance of a polymer electrolyte.....	14
1.6 Cyclic voltammogram curve of a polymer electrolyte.....	17
1.7 Linear sweep voltammetry curve of a polymer electrolyte.....	17
1.8 Density functional theory (DFT) abandons the many-particle electron reality in favor of electron density.	21
2.1 The picture of a) GE, b) fCNTGE, c) GOG; SEM images of d) GE, e) fCNTGE, f) GOG; g) cathode material; h) anode material	31
2.2 Ionic conductivity of fCNTGE samples with fCNTs containing different Oxygen contents	32
2.3 FTIR spectra of pure PVA, fCNTGE, GE and GOG.....	35
2.4 XRD patterns of pure PVA, GOG, GE, and fCNTGE.....	36
2.5 TGA curves of pure PVA, GE, GOG and fCNTGE	37
2.6 Differential scanning calorimetry (DSC) thermogram of GE, GOG and fCNTGE.....	38

LIST OF FIGURES
(continued)

Figure		Page
2.7	Stress-strain curves of GE, GOG, and fCNTGE samples	39
2.8	The dynamic shear modules of (a) GE and (b) fCNTGE with strain	41
2.9	The Nyquist plots for the GE, GOG and fCNTGE	43
2.10	CV curves of a) GE and fCNTGE, at 0.05 mV s ⁻¹ scan rate; b) GE,	43
	c) fCNTGE, d) GOG with different scan rates	
2.11	a) DC polarization curve; b) Linear sweep voltammograms at scan rate 0.05 mV/s for GE, fCNTGE, and GOG	45
2.12	Discharge curves under different rates a) C/20, b) C/10; c) Zinc anode (grey) and silver cathode (black), d) 3D-printed Ag-Zn batteries	48
3.1	DFT optimized geometry for (a) CNT, (b) fCNT, (c) ffCNT, and (d) fffCNT	56
3.2	Optimized geometry of one monomer (PVA) ₁ interaction with (a) CNT, (b) fCNT, (c) ffCNT, and (d) fffCNT; two monomer (PVA) ₂ interaction with (e) CNT, (f) fCNT, (g) ffCNT, and (h) fffCNT; three monomer (PVA) ₃ interaction with (i) CNT, (j) fCNT, and (k) ffCNT	57
3.3	Electron density of (a) CNT-(PVA) ₁ , (b) fCNT-(PVA) ₁ , (c) ffCNT- (PVA) ₁ , (d) fffCNT-(PVA) ₁ , (e) CNT-(PVA) ₂ , (f) fCNT-(PVA) ₂ , (g) ffCNT-(PVA) ₂ , (h) fffCNT-(PVA) ₂ , (i) CNT-(PVA) ₃ , (j) fCNT- (PVA) ₃ , and (k) ffCNT-(PVA) ₃	60
3.4	The adsorption configuration of a Zn ion with a (a) CNT-(PVA) ₁ , (b) fCNT-(PVA) ₁ , (c) ffCNT-(PVA) ₁ , (d) CNT-(PVA) ₂ , (e) fCNT-(PVA) ₂ , (f) ffCNT-(PVA) ₂ , (g) CNT-(PVA) ₃ , (h) fCNT-(PVA) ₃ , and (i) ffCNT- (PVA) ₃ complex	64
4.1	DFT optimized geometry for (a) CNT-Hg, (b) fCNT-Hg, (c) ffCNT-Hg (d) CNT-NO, (e) fCNT- NO, (f) ffCNT-NO, (g) CNT-O ₃ , (h) fCNT-O ₃ , (i) ffCNT-O ₃ , (j) CNT-NH ₃ , (k) fCNT- NH ₃ , (l) ffCNT- NH ₃ (m) CNT- SO ₂ , (n) fCNT-SO ₂ , (o) ffCNT-SO ₂ (p) CNT-PTFE, (q) fCNT-PTFE, (r) ffCNT-PTFE (s) CNT-PAN, (t) fCNT- PAN, (u) ffCNT- PAN	74
4.2	DFT Optimized Geometry for (a) CNT-PFOS (b) ffCNT-PFOS (c) CNT- PFOA (d) ffCNT-PFOA	75

LIST OF FIGURES
(continued)

Figure		Page	Page
4.3	Electron density of (a) CNT-NO, (b) fCNT- NO, (c) ffCNT- NO, (d) fCNT- SO ₂ , (e) ffCNT- SO ₂ , (f) CNT- SO ₂ , (g) CNT-O ₃ , (h) fCNT-O ₃ , (i) ffCNT-O ₃ , (j) CNT-PAN, (k) fCNT-PAN, (l) ffCNT-PAN (m) fCNT-NH ₃ , (n) ffCNT-NH ₃ (o) ffCNT- NH ₃ , (p) CNT-PTFE, (r) fCNT-PTFE, (q) ffCNT-PTFE.....	81	
4.4	Electron Density of (a) CNT-PFOS (b) 90 ⁰ ffCNT-PFOS (c) CNT-PFOA (e) 90 ⁰ ffCNT-PFOA.....	81	

CHAPTER 1

INTRODUCTION

1.1 Objective

The objective of this dissertation is to study applications of functionalized carbon nanotubes (fCNTs) for energy storage devices and membranes.

First, fCNTs and graphene oxide (GOs), as components in gel electrolytes, have been used to improve ionic conductivity, electrochemical diffusion, mechanical strength and study the effectiveness of the GEs for Zn-Ag₂O battery system.

Second, computational modeling of the interactions between gel electrolyte components such as fCNTs, PVA, and the working ion has been studied. The nature of the interaction between PVA dendrimers, fCNTs, and Zn ions is investigated on the atomic level by using Density Functional Theory (DFT) calculations.

Third, computational modelling is used to understand how fCNT displays better performance in membrane separation and investigate if the same trend is observed for different pollutants as well. The nature of interactions between the pollutants and raw and functionalized CNTs were studied on the atomic level by using DFT calculations.

1.2 Background Information

1.2.1 Introduction to Gel Electrolyte Systems

Electrolytes, with good interfacial stability, are a crucial component in electrochemical devices. The development of novel gel polymer electrolytes (GEs) with good interface stability and better manufacturability is important for the development of next generation electrochemical devices. A gel electrolyte (GE) is a hybrid electrolyte material, which combines the beneficial characteristics of both liquid and solid systems [Ahmad, 2020 #96]. Compared with liquid electrolytes, GEs do not require safety encapsulation materials of high standard [2] and thus do not limit the battery geometry. This opens new design opportunities for energy storage. Also, they can provide high reliability without electrolyte leakage and volatilization and can be used in conformal and flexible batteries and in separator-free devices [4]. The development of novel gel electrolytes with low reactivity, flexibility, good interfacial stability, and better manufacturability are important for the development of the next generation of batteries [5]. In batteries, GEs have been used as ionic conductors as well as separator for lithium-ion [2, 6, 7], aluminum-air [8], magnesium-ion, [5], sodium-sulfur [9] and zinc-air battery systems [10, 11].

Gels can be obtained as a result of either a chemical or a physical cross-linking process (Figure 1.1). When gelation occurs, a dilute or a more viscous polymer solution is transformed into a system of infinite viscosity, i.e., a gel. A gelled solution does not exhibit any flow when a tube containing the solution is tilted.

Chemical cross-linking is a covalent bonding of polymer chains by a chemical reaction to form a certain number of tie or junction points, as presented in Figure 1a. Chemical gels are covalently crosslinked network polymers swollen in a large amount of solvent and covalent cross-linking leads to the formation of irreversible gels. In such gels, the number of tie-points essentially does not change upon variation of the external conditions such as temperature, concentration, or stress [12]. Physical gels are reversible and occur as a result of the intermolecular association by electrostatic, van der Waals, or hydrogen bonding interactions [13] (Figure 1.1 b-c).

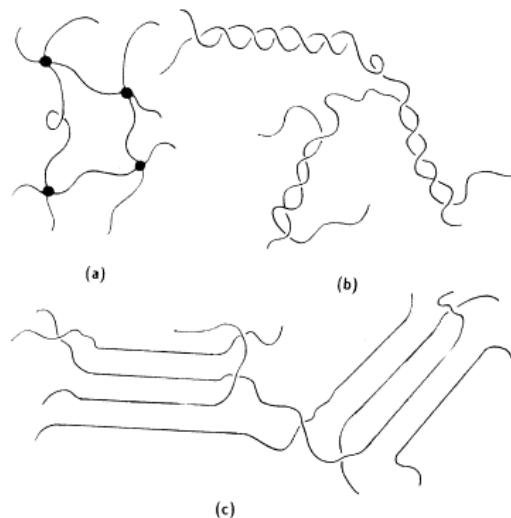

Figure 1.1 Schematic Illustration of Gel Through A) Chemical Network with Junction Points, and B-C) Physical Network Having Junction Zones [14, 15].

A GE is a polymer swollen by a liquid electrolyte. These electrolytes exhibit high ionic conductivity at room temperature but have poor mechanical properties. To solve this problem, nanoparticles can be used to improve the electrochemical stability and mechanical properties without decreasing the ionic conductivity. A plasticizer can also change the polymer matrix in gel electrolyte systems as it makes segmental motion easier

or gives liquid like character like that of a liquid electrolyte. These two together give rise to the high ionic conductivity in the gel electrolyte system. The ionic conductivity of a gel electrolyte is around 10^{-3} Scm^{-1} at room temperature which is far above that of a solid electrolyte [16, 17].

Because of the mechanism of ionic conduction in these systems, the ionic conductivity can be improved by increasing the motion of the polymer segment. One of the typical preparation procedures of the GE electrolytes is dissolving the polymer and salts in a selective solvent to form a homogeneous solution. An illustration of ionic conduction mechanism in lithium is shown in Figure 1.2 [18]. The lithium salt dissociates and dissolves in the polymer matrix to initiate free ions. The lithium ion organizes with oxygen atoms with a fixed ratio in the PEO chain and the ionic conduction mostly occurs in the amorphous phase. Ions are transported easily in the amorphous region, thus improving the ionic conductivity [19]. These complex ions move with the segment of polymer chain. Thus, the cations move freely from one electrode to another while an electric field is applied across the polymer electrolyte. Generally, this motion can be increased through modification of the molecular structure, such as grafting, copolymerizing, mingling with more flexible polymers.

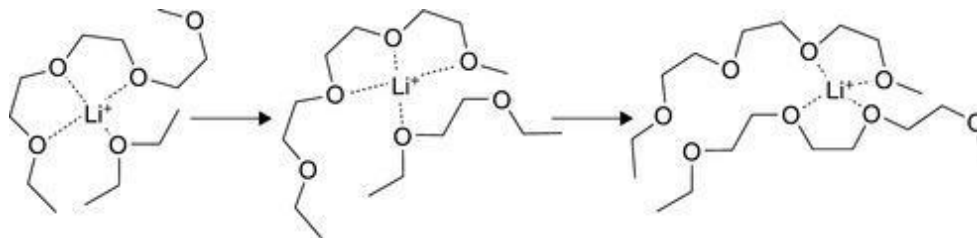

Figure 1.2 Ion Conduction Mechanism in the Polymer Electrolyte [18].

1.2.2 Literature Review of Gel Electrolyte Systems

During the scale up of manufacture of battery from laboratory setup to full production, the mechanical strength of electrolyte needs to be improved for manufacturability by conventional large-scale coating processes. The use of different polymers, plasticizers, and modification to increase the ionic conductivity of GEs is reviewed here. Many different polymers have been used in GEs. A sample of different examples are described here.

The most common polymers used as the polymer matrix in gel polymer electrolytes include polyethylene oxide (PEO), Poly (*p*-phenylene oxide) PPO, polyacrylonitrile (PAN), poly (methyl methacrylate) (PMMA), poly (vinyl chloride) (PVC), poly (vinylidene fluoride (PVdF), poly (vinylidene fluoride-hexafluoro propylene) (PVdF–HFP), etc. The first proposed concept of the GE contained a small amount of organic liquid known as a plasticizer, such as chain-like ester and cyclic carbonic acid ester [20]. Until now, it has been the most common approach for enabling the ionic conductivity to reach the magnitude of 10^{-3} S/cm at room temperature; for example, plasticizer-containing PAN or PMMA polymer hosts were reported to provide very high ionic conductivity [21].

Flora et al. prepared a polymer blend electrolyte with various ratio of poly(acrylonitrile) (PAN) and poly (methyl methacrylate) (PMMA) as host polymers and lithium perchlorate (LiClO_4) as an ionic salt. Among the different concentrations, the polymer electrolyte film containing PAN/PMMA (75:25 wt.%) was concluded to be a suitable candidate for the battery applications on the basis of ionic conductivity which showed the order of 0.019×10^{-5} S cm⁻¹ [22].

Kucharskiet et al. prepared a PEO based polymer GE. The electrolyte demonstrated a conductivity of 10^{-4} Scm^{-1} at room temperature [23]. When the salt concentration was increased to 10 wt %, the conductivity increased to $6.4 \times 10^{-3} \text{ Scm}^{-1}$, but the mechanical properties were poor due to deficient gel formation [23].

Zaghib et al. studied the performance characteristics of polymer GEs for C and LiFePO_4 cells [24]. In the GE, the polymer chain segments are highly mobile. By modifying the PEO structure with introduction of substituents and the synthesis of branched and network polymer matrices, the conductivity of the corresponding gel electrolytes was enhanced [24]. Although gel electrolytes based on PVDF and PVDF-HFP display high ionic conductivity, they have some disadvantages such as high cost and the overall yield of their synthesis [25].

Vickraman et al. studied polymer gel electrolytes based on PVC, which exhibited conductivity of an order of magnitude of 10^{-6} Scm^{-1} at room temperature [26]. Furthermore, their matrix was modified using PVDF-HFP since mixing of various polymer components has a beneficial effect on the electro-chemical properties of gel electrolytes as will be discussed in more detail later. However, in this case, the ionic conductivity was decreased because of poor compatibility of polymers and their inability to hold the liquid electrolyte [26].

Kim and Oh found that ionic conductivity and the mechanical stability of polymer gel electrolytes based on PMMA modified with the interpenetrating polymer network components [27]. Ito et al. investigated the increase in ionic conductivity using PEG as plasticizer which was mainly attributed to the reduction in crystallinity as well as the increase in free volume of the system [28].

The PAN-based electrolyte offers homogeneity among the polymer hosts that are used for gel electrolytes. As reported by Abraham and Alamgir, a typical electrolyte comprising PAN showed an ion conductivity of $1.1 \times 10^{-3} \text{ S/cm}$ at -10°C and $1.71 \times 10^{-3} \text{ S/cm}$ at 20°C [29].

PVDF has been chosen as a polymer host by virtue of its multifold appealing properties. PVDF-based polymer electrolytes are highly anodically stable due to the strongly electron-withdrawing functional group (C—F). Wang et al. studied the plasticized PVDF system and reported an increase in the ion conductivity. They explained that the ion conductivity of a polymer electrolyte depends strongly on the ionic mobility within the material [30].

Wang et al. reported a PMMA-based electrolyte for a lithium-ion battery with improved mechanical properties [30]. The lithium cell fabricated with this gel polymer electrolyte showed excellent electrochemical properties.

Zhu and Huang investigated the electrochemical properties of PVC and PMMA-based gel electrolytes [31]. Their results indicated that these electrolytes acquire a high ionic conductivity and a wide electrochemical stability window. However, their application in rechargeable lithium-ion batteries was hindered by the corrosion of the lithium electrode interface.

Next, fillers have been shown to affect both the conductivity and mechanical properties. Nanocomposites based on PMMA in GE systems were studied by Ahmad et al. [32]. The nanofiller GE composite exhibited better mechanical properties than the unfilled polymer electrolytes [32]. Another PEO-based nanocomposite GE system was studied by Nan et al. [33].

A net improvement in ionic conductivity and a very high Young's modulus was obtained at room temperature, higher than the unfilled PEO electrolyte. This improvement in mechanical properties was found to correlate to a specific interaction between SiO₂ and PEO [33]. Gel nanocomposite polymer electrolytes based on PVDF-HFP were studied in another research [34] and it was found that the diffusion coefficient indicated reduction in both anion and cation mobilities by the presence of the filler [34].

Finally, the copolymerization or blending with polymers has been proposed to improve the performance of polymer electrolytes. PVDF, PVC, and PAN have been mostly used as matrix polymers in plasticized polymer electrolytes with ionic conductivity in the order of 10⁻³ S/cm at room temperature. However, they cannot completely fulfill the requirements for the high mechanical strength, long-term phase stability, and good adhesion to the electrode. Blending is more useful because of the ease of preparation and control of polymer electrolytes by changing the composition of blended polymer matrices.

For example, Park and co-workers investigated polymer electrolytes based on the blend of poly(vinylacetate) (PVA) and PVdF-HFP and the maximum ion conductivity reached 2.3×10⁻³ S/cm at room temperature [35]. By increasing the amount of PVA content, the mobility and concentration of the free ions in the polymer electrolyte were reduced, showing a decrease in the ionic conductivity [35].

In another example, Oh and Kim attempted to develop a new gel electrolyte that exhibited a high ionic conductivity and excellent film formation ability [36]. They developed a polymer system consisting of a matrix polymer and a filling polymer for absorbing electrolyte solution and gelation of the microporous gel electrolyte for

sustaining the mechanical integrity [36]. Liu and colleagues also invented gel polymer films by mixing PMMA with PVDF–HFP, the latter showing better compatibility with the liquid electrolyte. [37].

There is a wide variety of GEs based on different polymers, and different methods such as adding fillers and blending have been used to improve their properties. In the next section, the use of functionalized carbon nanotubes as fillers will be discussed.

1.2.3 Functionalized Carbon Nanotubes (fCNT) in Gel Electrolyte Systems

Composite electrolyte with the idea of incorporating electrochemically inert fillers into polymer matrices can provide two advantages. One is to improve the stability at the interface with electrodes and the other is enhancement of ionic conductivity at low temperatures. Generally, high surface area particulate fillers such as chitosan [38], silica [39], CNTs [40] have been studied in polymer matrices [41].

Among them, CNTs are highly flexible which can improve the interaction and cross-linking with polymer molecules that further enhances morphological features and ionic conductivity of composite electrolytes. They have been used for energy storage devices because of their high specific surface area and mechanical elasticity of the tubular network [42]. Also, the superior electrical conductivity enables CNT as an additive to composite electrodes and facilitates activation of poorly conducting electrode materials making them electrochemically active [43].

On the other hand, CNTs have played an important role as sorbents for selective solute transport in different membrane applications which have promoted higher flux, selectivity, and reduced fouling in membrane systems [44, 45]. It was observed that

immobilization of CNTs on membrane surfaces has a great effect on the interaction between the membrane and solutes [46-48]. The surface areas of CNTs are between 100 and 1000 m²/g [49] which make them excellent candidates as sorbents.

However, while CNTs display high water permeability and good adsorptive capabilities [50], they also have some disadvantages such as weak van der Waals interaction [51], insolubility for adsorbing materials in aqueous solutions [52], and agglomeration [53]. Functionalized CNTs (or fCNTs) lead to improvements in hydrophilicity, specific charge transport and reducing agglomeration. Recently, CNTs functionalized by oxygen containing functional groups such as –COOH and –OH groups have become particularly promising material for a wide range of applications from electronics to biotechnology as they are easily synthesized using oxidative treatments [54]; they enhance adsorptive capabilities [41] and improve solubility [55].

CNTs can be functionalized by two methods: chemical and physical methods [56]. The characterization corresponding to these methods are summarized in Figure 1.3. When CNT is bonded to the functional group using a chemical reaction, this is called chemical functionalization. If the modifier is adsorbed on CNT or stored in the hole of CNT, it is a physical method [57].

For covalent functionalization, introducing carboxylic groups on CNTs is usually the first step, generally prepared by microwave treatment with strong acids, refluxing, and sonication [58]. In an acid treatment, CNT is reacted with a concentrated acid solution such as sulfuric and nitric acid [59]. Commonly, the mixtures of the acid are 3/1 or 1/3 v/v of H₂SO₄/ HNO₃ solution [60]. Detailed procedures of acid treatment can be found in the literature. In summary, CNT is dispersed in an acid mixture at relatively

high temperature for a while. Afterwards, the CNT is washed, filtered, and dried. The treatment time, the strength of the reagents, and reaction temperature control the degree of functionalization in terms of the number of carboxylated groups.

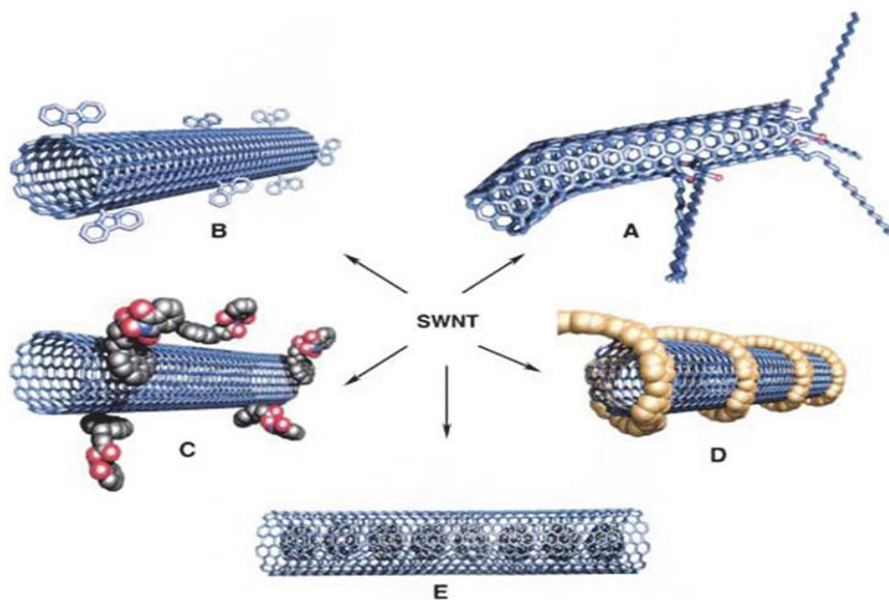

Figure 1.3 Functionalization possibilities for CNTs: A) Defect-group Functionalization, B) Covalent sidewall functionalization, C) Non-covalent exohedral functionalization with surfactants, D) Non-covalent exohedral functionalization with polymers [61].

The chemistry of microwave treatment has been seen to be more efficient, ecofriendly, and faster than conventional methods so far [62]. Different types of reactions and organic syntheses with high yields under controlled pressure and temperature, and high-purity products due to the short residence times have been reported [63, 64]. Besides, the further polarization of the dipoles under microwave radiation can facilitate modification of chemical activation parameters [65].

The microwave treatment was observed to lead to increase in oxygen content with increasing carboxylation as well as significant tube damage [66]. Also, the surface

area was found to be increased since both acids and microwave treatment led to carbon-carbon bonds to break, leaving defects on CNTs [66].

1.2.4 Electrochemical Impedance Spectroscopy (EIS)

A direct current (DC) method cannot be used to calculate the resistance of a dielectric material due to the polarization of charges taking place at the phase boundaries of the sample or at the electrode-electrolyte interface. Therefore, other techniques are needed, one of which is Electrochemical Impedance Spectroscopy (EIS). Impedance measurement using EIS is performed by applying a low amplitude sinusoidal potential (AC voltage) over a range of frequencies to the sample. EIS measures the time response, which enables the evaluation or decoupling of small-scale polarization and conductance mechanism at the electrode interface and within the electrolyte. EIS results can be presented as a Nyquist plot or a Bode plot. For a Bode plot, the frequency is precise while for a Nyquist plot, the frequency is hidden.

GEs, consisting of an ionic salt dissolved in a polymer, can present both capacitive and resistive behavior as reflected from the real (Z') and imaginary (Z'') parts of the complex impedance (Z^*). Figure 1.4 shows a schematic drawing of GE sandwiched in between two blocking electrodes and the possible equivalent circuit model, in which the resistance and capacitance are in parallel that can be distinguished using impedance spectroscopy over a range of frequencies.

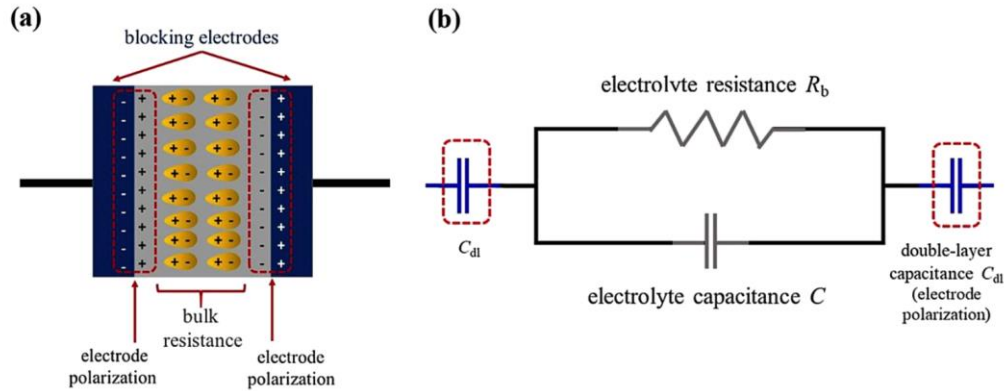

Figure 1.4 (a) Schematic drawing of GE sandwiched between two blocking electrodes. (B) equivalent circuit (model) of GE sandwiched between two Blocking Electrodes [67].

The data plots of Z' against Z'' of the impedance measured under AC over a range of frequencies, where the frequency is hidden, are illustrated in Figure 1.5. These plots are scientifically known as frequency dispersion spectrum or frequently called a Nyquist plot [68]. Each data point in the Nyquist plot represents the impedance of the electrolyte measured at a certain frequency. In fact, the plot is separated into frequency regions known as the high frequency region and the low frequency region. The high frequency region is plotted toward the origin of the figure whereas the low frequency region is plotted outward from the origin of both x - and y -axes. The value of the point of intersection between the plot and the x -axis represents the value of the bulk resistance (R_b) of electrolyte.

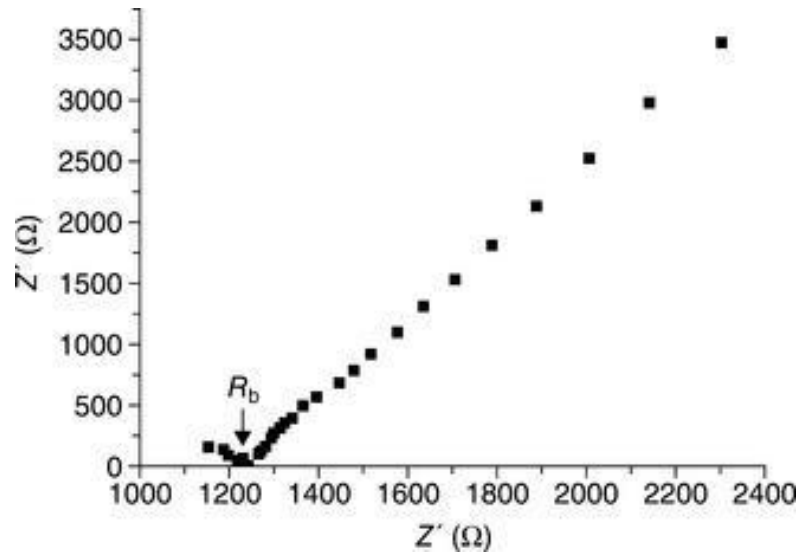

Figure 1.5 Typical AC impedance of a polymer electrolyte [69].

The ionic conductivity can be analyzed by using the following Equation 1.1 [70].

$$\sigma = \frac{h}{R_b S} \quad (1.1)$$

where R_b is the bulk resistance of polymer electrolyte, h is the distance between two electrodes and S is the total contact area of the electrolyte with electrodes.

1.2.5 Transference Number and Electrochemical Stability Window

The electrons and ions (cations and anions) can contribute to conduction processes in an ion conducting system. Thus, it becomes important to separate the current and distinguish how much is carried by each mobile species; this is referred as the measurement of the transference number. Ionic transference number is a technique used

to separate the different contribution of electrons and ions from total charge transport. It is a dimensionless parameter which gives information about the contribution of the charged species present in the bulk of electrolyte to the overall charge transport across the measured system.

GEs are placed between two blocking electrodes and current is monitored as a function of time by applying a small dc voltage. The current decreases with increase in time due to polarization of mobile ions at the electrodes. At the beginning, both the ionic and electronic components contribute but after a while, current either reaches a residual constant value (for mixed ionic/electronic conductor) or attain zero (for a pure ionic conductor). Therefore, the ionic transference number are calculated using Equation 1.2 [34]:

$$t_{ion} = 1 - \frac{I_e}{I_t} \quad (1.2)$$

where I_t , is the total initial current or due to ions or as a combined result of ion and electron contribution while constant residual current (I_e) is due to electron contribution only.

A large transference number can reduce the concentration polarization of electrolytes during charge–discharge steps, and thus produce a higher power density. It is highly desirable that the transference number approaches 1 in an electrolyte system. However, many existing electrolyte systems, either liquid or polymeric, have transference numbers less than 0.5 [7].

The gel electrolyte is interposed between the cathode and the anode, and its chemical stability should not have undesired chemical reaction as the electrodes come into direct contact. In general, the electrochemical stability can be characterized by an electrochemical window measured via a linear sweep voltammetry (LSV) shown in Figure 1.6. The flat areas occurring in the figure represent the electrochemical window. LSV is voltametric method; the current at a working electrode is measured while the potential between the working electrode and reference electrode is swept linearly vs. time from lower to higher potentials.

The objective is to detect at which potential the GE will be oxidized/reduced and, thus, degraded. Oxidation or reduction of species is registered as a peak or trough in the current signal at the potential at which the species begins to be oxidized or reduced. Principally, when LSV is applied, a sudden increase in the current appears at a given potential and indicates oxidation (faradic current). Figure 1.7. shows an example of an experimental LSV profile. Experimental parameters include scanning rate, temperature, determination of the potential estimated as the beginning of the oxidation, or the minimum current value considered as a realistic value meaning that oxidation occurs.

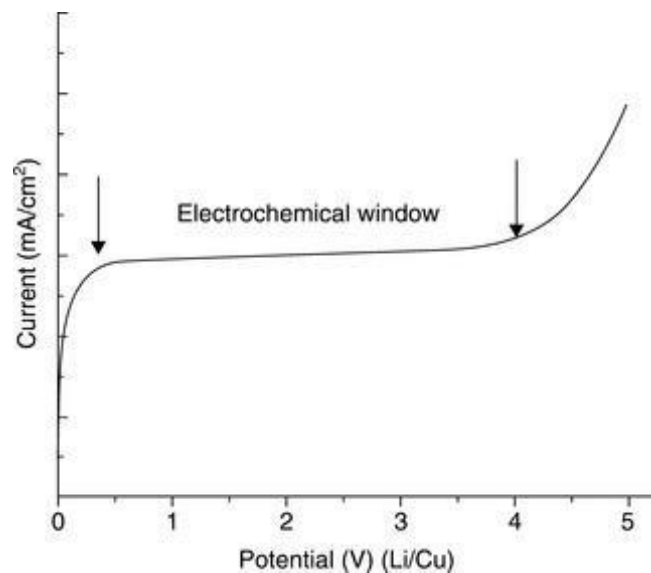

Figure 1.6 Linear Sweep Voltammetry Curve of a Polymer Electrolyte [71].

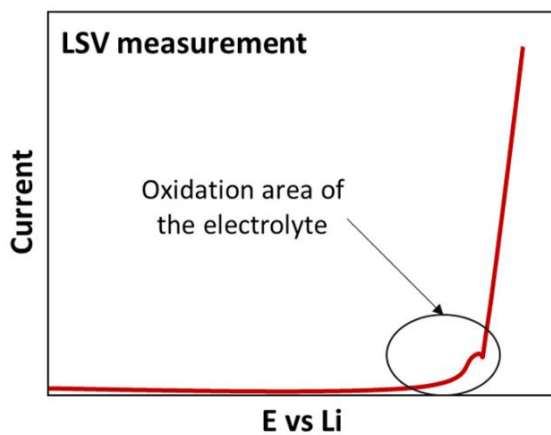

Figure 1.7. Scheme of traditional cell for electrochemical window evaluation by LSV measurement [72].

1.2.6 Introduction of Density Functional Theory (DFT)

Ionic conductivities of gel electrolyte systems are recognizably raised by numerous orders of magnitude after adding plasticizers to the gel electrolyte system. According to the research, it can be concluded that the ionic mobility plays a key role in the achievement of higher ionic conductivity in polymer electrolytes. However, high

compatibility between electrolyte components should be assured to obtain a homogeneous membrane and enable the polymer to dissolve.

Recently, some modifications have been carried out to enhance the efficiency in membrane technology. For example, immobilizing nanomaterials such as carbon nanotubes (CNTs) [73], silica [74], and polymers [75] have shown improvement in flux and stability of the membrane [76]. Furthermore, sorbate and sorbent interaction in membrane systems can be affected by the capillary forces in nanotubes, presence of defects, or polarizability [77, 78], all of which directly influence the separation performance. For instance, deposition of dissolved elements on the membrane pores can cause membrane fouling [79] and capillary forces have been shown to produce bending during the drying process [80]. At this point, understanding interactions at the membrane interface as well as electrolytes is becoming a very important parameter for correlation of components [81].

On the other hand, the electrochemical stability at the electrode/electrolyte interface is the most important criteria for an energy storage device with a highly oxidizing cathode material before a reliable gel electrolyte battery with long life cycle can be realized. Modern computational approaches can provide accurate energies of surface chemical reactions which is important to design and optimize new materials for energy storage devices [82].

Density Functional Theory (DFT) is an approach to quantum chemistry where a system of interacting electrons is mapped onto a system of non-interacting ones in an effective potential [83]; it can provide accurate and valuable information on molecular geometries and properties. It can also be used to compute the electronic properties of

transition metals and compounds faster and more accurately [84] over classical quantum mechanics.

For a molecule or system, it is critical to know the changes in energy when the atoms move around. The configuration of atoms that gives the lowest energy is considered to be the most stable state (“ground state”). This can be done by solving the Schrodinger equation 1.3 [85].

$$H\psi = E\psi. \tag{1.3}$$

In this equation, H is defined as the Hamiltonian operator and Ψ is a set of solutions, or eigenstates, of the Hamiltonian. Each of these solutions, Ψ_n has an associated eigenvalue, E_n , a real number that corresponds the eigenvalue equation [86].

The terms making up the Hamiltonian are the:

- ion-electron potential energy
- ion-ion potential energy
- electron-electron energy
- kinetic energy
- exchange-correlation energy

If the nuclei positions are defined with $R_1 \dots R_m$, the ground state energy as a function of the positions of these nuclei will be $E(R_1 \dots R_m)$, which is called potential energy surface of the atoms [87]. On the other hand, for defining atoms' location, both

its nucleus and electrons position must be determined. Since the atom nuclei are much heavier than individual electrons, those electrons can respond to changes in their surroundings much faster than the nuclei. As a result, the physical question can be solved for a fixed position of the atomic nuclei, which the equations explain via the movement of electrons.

According to Born-Oppenheimer approximation, the wave functions of atomic nuclei and electrons in a molecule can be treated separately and the lowest energy state is accepted as the ground state of electrons [88]. Therefore, the energy terms describing the energy of the nuclei are approximately zero.

With these terms removed; the Schrödinger equation can be defined by the following formula containing only electron terms [89].

$$\left[\frac{\hbar^2}{2m} \sum_{i=1}^N \nabla_i^2 + \sum_{i=1}^N V(\mathbf{r}_i) + \sum_{i=1}^N \sum_{j<i}^N U(\mathbf{r}_i, \mathbf{r}_j) \right] \psi = E\psi. \quad (1.4)$$

Here, m is the electron mass, the first term in brackets is the kinetic energy of each electron, the second term is the interaction energy between each electron and the collection of atomic nuclei, and the third term is the interaction energy between different electrons. Ψ is the electronic wave function, and E is the ground state energy of the electrons which is independent of time. This is the time independent electronic Schrödinger equation. However, this equation still cannot be solved for a real system with interacting electrons. To move forward, DFT is utilized.

DFT is based on a fundamental mathematical theorem explained by Hohenberg and Kohn in the 1960s. According to their first theorem, the ground state energy from Schrödinger's equation is a unique functional of the electron density [90]. To understand the importance of this result, it is required to explain what a functional is: a functional is a function of a function [88].

Thus, Hohenberg and Kohn's theorem can be stated as the ground-state energy E that can be expressed as $E(n(r))$, where $n(r)$ is the electron density. The Hohenberg and Kohn theorem declares that the electron density of any system determines all ground state properties of the system. In this case, the total ground state energy of a many-electron system is a functional of the density. By knowing the electron density functional, the total energy of our system can be determined [90]. By focusing on the electron density, it is possible to derive an effective one-electron-type Schrödinger equation.

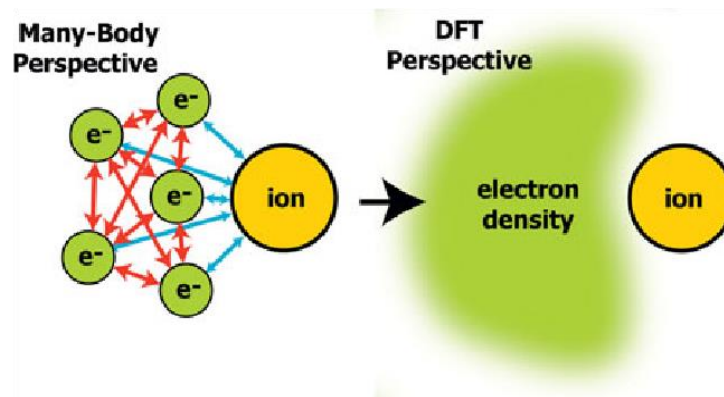

Figure 1.8. Density Functional Theory (DFT) abandons the many-particle electron reality in favor of electron density [91].

This theorem also explains the one-to-one correlation between the ground state electron density and ground state wave function [92]. Because the ground-state electron density uniquely determines all properties, including the energy and wave function of the ground state, there is an exact dependence between the ground-state wave function and the electron density. This allows to reduce the complexity from $3N$ dimensions to just 3 dimensions. While many body wave function relies on all spatial coordinates in electron system, the electron density only depends on three spatial coordinates (Figure 1.8). Thus, electron density makes object simply computationally, which is the foundation of desirable computational properties of DFT.

However, the first Hohenberg and Kohn theorem does not generate information on how to find the functional. The second Hohenberg and Kohn theorem expresses a critical property of the functional and states that “the electron density that minimizes the energy of the overall functional is the true electron density corresponding to the full solution of the Schrodinger equation” [93].

If the true functional form is known, the minimum energy can be found by varying the electron density to find the ground state electron density. Once the ground state electron density is known, all the properties can be calculated. This variational principle is used in practice with approximate forms of the functional.

After this, Kohn and Sham showed how to turn the system of interacting electrons to the system of non-interacting electrons [94]. The total energy functional can be re-written as the sum of different interactions as:

$$E[n(r)] = \int V(r)n(r)dr + T[n(r)] + E_H[n(r)] + E_{XC}[n(r)] \quad (1.5)$$

The first term is the potential energy, the second term is the kinetic energy, the third term is the Hartree energy (it describes the interaction of the electron density with itself), and the fourth term is the exchange-correlation energy (describing all the other electron-electron interactions). Up to now, density functional theory has been exact, and all terms except for the exchange-correlation energy can be solved by choosing a trial charge density and iterating on it until minimization; however, because there is no exact formula for the exchange-correlation energy, which contain all the electron-electron interaction information, assumptions must be made.

To approximate the exchange-correlation energy, different “functionals” have been developed and are used to calculate this contribution to $E(n(r))$. The one used in this work is B3LYP (Becke, 3-parameter, Lee, Yang, Parr), which is one of the most used in the world [95, 96].

$$E_{xc}^{B3LYP} = (1 - a)E_x^{LSDA} + aE_x^{HF} + b \Delta E_x^B + (1 - c)E_c^{LSDA} + cE_c^{LYP} \quad (1.6)$$

Here, a, b, and c are three parameters, while the other terms are other different approximations of the exchange-correlation energy. Now with these functionals, density functional theory calculations can be performed quickly and reliably.

1.2.7 Conclusion

The need for efficient and clean energy storage devices is more important today and providing power to numerous portable consumer electronic devices such as laptops, mobile phones, personal digital assistants (PDAs), or for implantable medical applications will be a massive task. Gel electrolytes are obligatory for these developments. They are expected to take the place of liquid electrolytes in the future since they have many advantages over their liquid and solid counterparts. During the past 30 years, revolutionary progress has been made in the preparation, characterization, and electrochemical evaluation of various gel electrolytes. However, for the state-of-art technology of gel electrolytes, there are still several technical limitations to be improved. In any case, GEs are a developing trend for both electrochemistry science and polymer science and is a very attractive field to perform research.

CHAPTER 2

FUNCTIONALIZED CARBON NANOTUBE DOPED GEL ELECTROLYTES WITH ENHANCED MECHANICAL AND ELECTRICAL PROPERTIES FOR BATTERY APPLICATIONS

2.1 Introduction

Several polymers including poly(acrylonitrile) (PAN) [97, 98], poly(vinyl alcohol) (PVA) [99-102], poly(ethylene oxide) (PEO) [2, 103], poly(methyl methacrylate) (PMMA) [76, 104], and copolymer poly(vinylidene fluoride-hexafluoropropylene) (P(VDF-HFP)) [5, 105] have been used to make gel electrolytes (GE) for solar cells [106-109], membranes [110, 111], and supercapacitors [4, 100, 112, 113].

GEs can be limited by their ionic conductivity [7, 114] and poor mechanical properties [7, 115]. In an effort to improve the mechanical and electrical properties of GE, nanosized inorganic fillers have been used which have altered crystallinity [116] and stabilized the conductive amorphous phase [117]. Moreover, its electrochemical properties strongly affected the battery performance in terms of rate capability and cyclability [76].

PVA is a semi-crystalline hydrophilic polymer with high capacity for holding water and salts. Fillers such as GO [111, 118, 119], chitosan [38], silica [39], CNTs [40] have been added to PVA to generate gel composite electrolytes. The fillers which have abundant oxygen functional groups [113] are readily dispersible in water [120] and can interact with polar functional groups within polymers [121]. PVA simultaneously interacts with these fillers via both -inter and -intra chain hydrogen bonds which make it a unique polymer [122]. For instance, GO fillers [123] in PVA provide good interfacial interaction and dispersion due to the interaction of OH

bonding [124].

CNTs are highly flexible which might improve the interaction and cross-linking with polymer molecules that further enhance morphological features and ionic conductivity of composite electrolytes. It has been used for energy storage devices because of its high specific surface area, mechanical elasticity of the tubular network and superior electrical conductivity [42]. Furthermore, functionalized CNTs (or fCNTs) lead to improvements in hydrophilicity, specific charge transport and reduction in agglomeration. Using fCNT with high surface area and oxygen-containing functional groups should be a wise strategy as an additional material to improve performance of GE and the incorporation of fCNT into gel as GEs for batteries has not been reported so far. The functionalized carbon nanotubes (fCNTs) may also generate gel structure with improved mechanical properties [125].

The objective of this research is to use fCNTs and GOs as components in gel electrolytes to improve ionic conductivity, electrochemical stability, mechanical strength and study the effectiveness of the GEs for Zn-Ag₂O battery system.

2.2 Experimental Description

2.2.1 Preparation of polymer gel electrolytes (GE), fCNT and graphene oxide (GO) doped polymer gel electrolytes

Raw multiwalled CNTs were treated for 5, 10, 30, 60, and 120 min respectively under microwave radiation to produce fCNTs. The GEs (PVA-KOH polymer gel electrolytes) were prepared by dissolving the appropriate weight of PVA in water. The KOH solution was added to PVA solution drop wisely and continuously stirred (at 80 °C for 2 hours) till a homogeneous viscous liquid. Concentration of PVA and

KOH solutions for the polymerization reaction were adjusted and it was found that an appropriate composition of the PVA-KOH-H₂O solution could be prepared with 80% H₂O, 6% PVA, and 14% KOH by weight. The gelation of PVA-KOH-H₂O was allowed to proceed at room temperature for another 2 hours. The fCNTGE was prepared with 0.018% fCNTs, 80.52% H₂O, 6% PVA, and 13.45% KOH. A similar formulation was used for GOG.

2.2.2 Preparation of electrodes

The battery anode paste was prepared by mixing 4% PEO, 94% zinc, 2% Bismuth (III) oxide in DI water; and the cathode paste was prepared by mixing 82% silver oxide, 8% carbon and 10% PEO in DI water. Silver paste on polyethylene terephthalate (PET) substrates was used as the current collector. Battery electrode inks were pasted onto current collectors and dried. The effective working area for each electrode was calculated as 3.98 cm². The typical mass of a cathode was 0.05 g, and mass for anode was 0.1 g (in excess).

2.2.3 Materials and Treatment

PVA (molecular weight: 75,000; Aldrich), KOH (Aldrich), polyethylene oxide (PEO; Aldrich; molecular weight: 400,000), zinc powder (>98.5; Fluka), silver (I) oxide (Aldrich), bismuth (III) oxide (Aldrich), and graphene oxide (Graphenea) were used as received without further treatment. Raw multiwall carbon nanotubes (rCNTs, purity 95%, diameter 20-30 nm, length 10-30 μm) were purchased from Cheap Tubes. fCNTs were obtained by microwave irradiation method from raw CNTs [66, 126]. Raw CNTs were treated in CEM Mars microwave reactor with a mixture of concentrated acid (H₂SO₄ and HNO₃) at 140 °C for 5, 10, 30, 60, and 120 min

respectively. Resulted products were filtered through a 0.3 μm membrane filter, then washed with Milli-Q water to a neutral pH and finally dried under vacuum at 65 $^{\circ}\text{C}$ to a constant weight.

2.2.4 Characterizations

The samples were characterized using a scanning electron microscope (SEM, JSM-7900F, JEOL). The ionic conductivity (σ) of samples were measured using an electrochemical impedance spectroscopy (EIS, Gamry Instruments, Reference 600+). The electrochemical testing was performed through cyclic voltammetry (CV) on a Homiangz 320C electrochemical analyzer versus a standard Ag-AgCl electrode. Galvanostatic discharge measurements were carried out using an MTI Battery Analyzer (Richmond, CA). Thermo-gravimetric analysis (TGA) was carried out by a thermal analyzer (PerkinElmer TGA 8000) and the melting temperature was investigated using differential scanning calorimetry (PerkinElmer, DSC 6000). X-ray diffraction (XRD, Philips EMPYREAN X-Ray Diffractometer) measurement was performed to examine their crystallinity characteristics. The polymerization was obtained by Fourier transform infrared (FTIR, Agilent Technologies Cary 600 Series). Rheological behaviors and mechanical properties of samples were evaluated with a rotational viscometer (Malvern, Kinexus).

2.3 Results and Discussion

2.3.1 Structural Characterization of GE, fCNTGE, and GOG

The functionalization via microwave treatment of CNTs in acids introduced oxygen-containing groups, especially hydrophilic carboxylic groups ($-\text{COOH}$) [62, 127] leading to high aqueous dispersibility of the products. The water content of the gel electrolyte is an important parameter to maintain the hydration of ions for better ionic transport. Various functionalization times were used to determine the optimum ionic conductivity of the polymer gel. The elemental analysis was carried out by EDX and shown in Table 2.1. As the treatment time was increased, there was a noticeable increase in oxygen to carbon ratio, although the increase was less significant after 30 min. Impedance spectroscopy measurements were used to evaluate the effect of the altered degree of functionalization on ionic conductivity (σ) of the gel electrolytes (Table 2.1.).

Table 2.1 Ionic Conductivity of Gel Electrolytes with Different Degree of Carboxylation

Gel Electrolyte Samples	CNT treatment time (min)	Carbon content in fCNTs % by weigh	Oxygen content in fCNTs % by weigh	Carbon to Oxygen Ratio	σ ($10^{-2} \text{ S cm}^{-1}$)
fCNTGE-5	5	92.2	7.3	16.9	5.3
fCNTGE-10	10	89.4	9.6	12.5	5.5
fCNTGE-30	30	87.9	12.1	9.8	6.2
fCNTGE-60	60	86.8	12.8	9.1	6.9
fCNTGE-120	120	85.8	13.3	8.6	6.8

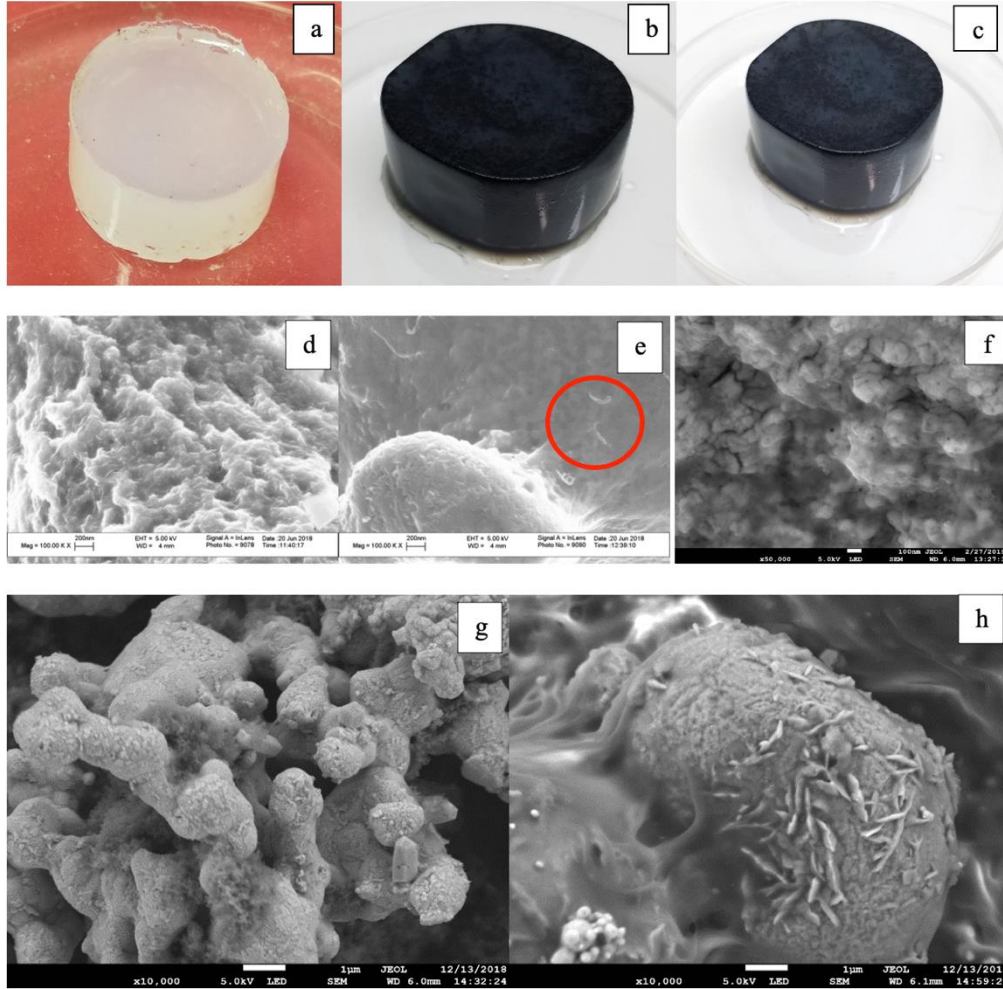

Figure 2.1 The picture of a) GE, b) fCNTGE, c) GOG; SEM images of d) GE, e) fCNTGE, f) GOG; g) cathode material; h) anode material.

The pictures of GE, fCNTGE, and GOG are shown in Figure 2.1a-c. No free flow of liquid was observed after the gelling process. SEM images are presented in Figure 2.1.d-h. The surface morphology of GE in Figure 2.1.d. showed rough structure with a 3-D network which allowed KOH to be entrapped in the PVA matrix. fCNTs were observed to be embedded in the electrolyte in Figure 2.1.e. While tube damage increased with treatment time, the circle in inset of Figure 2.1.e. corresponding to tubular structure of fCNT remained. Figure 2.1.f. shows the porous morphology of the GO-doped gel electrolyte. The electrodes and gels were dried during SEM sample

preparation. The pores and holes observed in dried gels were formed during the removal of water. In the original gels, these pores and holes held water contents and allowed ion movement.

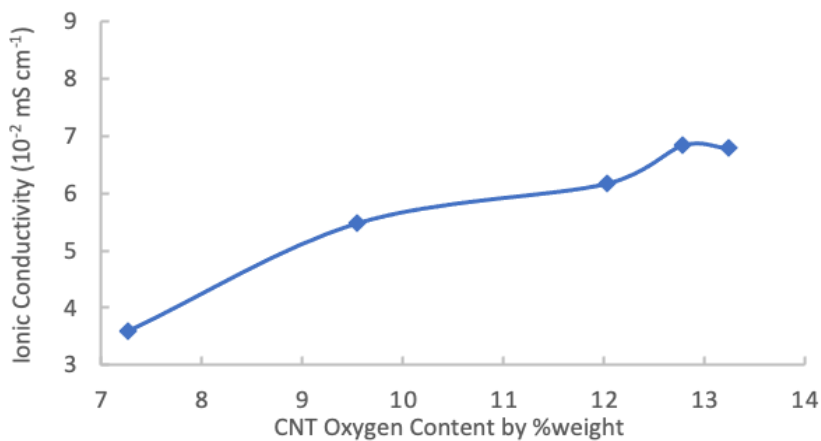
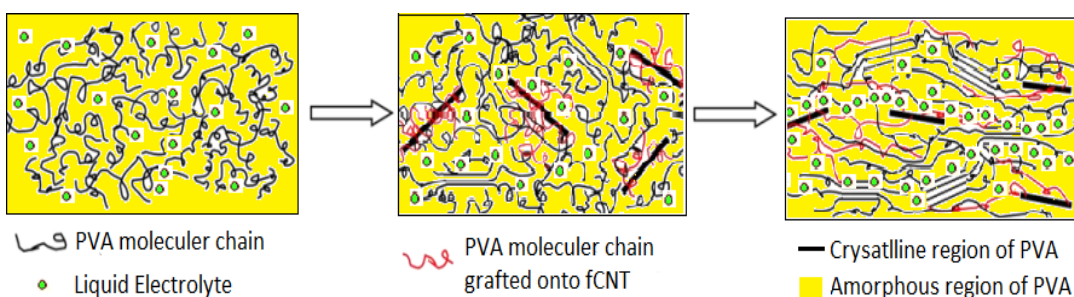

Figure 2.2 Ionic Conductivity of fCNTGE samples with fCNTs containing different oxygen contents.

As shown in Figure 2.2, the ionic conductivity was increased by increasing the oxygen content of fCNTs in gel electrolytes gradually. Overall, an optimized high ionic conductivity of about $6.9 \times 10^{-2} \text{ S cm}^{-1}$ was achieved when 60-minute treated fCNTs were used to prepare fCNTGE (Table 1). Therefore, 12.8 % oxygen was chosen as an optimal oxygen content level for fCNT-PVA-KOH gel electrolyte (fCNTGE) and was used for further evaluations.

The increase in ionic conductivity was attributed to the fCNTs serving as dielectric materials or a redox shuttle. It was observed that higher treatment time generated smaller particle sizes and less agglomeration in water [126, 128]. This led to the $-\text{COOH}$ groups to enhance dissociation of KOH and facilitated ion transport in the fCNT-doped gel electrolyte. When the oxygen level was low, fCNTs could not

accomplish well as redox shuttle, and the conductivity of the gel electrolyte was reduced. The fCNT bundles covered with hydroxyl groups (OH^-) of PVA could absorb both KOH and H_2O molecules. Accordingly, the OH^- ions can be transferred readily in the fCNTGE, which might contribute to the increase in ionic conductivity [129]. Moreover, hydrophilic properties of fCNTs [125] helped to conduct OH^- through its microchannel, which could also contribute to increased ionic conductivity. The proposed schematic gel mechanism representation was shown in Scheme 2.1. Suitable amounts of fCNTs were uniformly dispersed in the PVA matrix and the PVA grafted fCNTs chains were oriented, resulting in strengthening their interfacial bonding. Segmental motions of the PVA grafted fCNTs might cause the increase of conductivity [130]. When the fCNTs were added into the gel, due to the abundant oxygen containing functional groups, the fCNTs interacted with the copolymer to form amorphous phase and decreased the degree of crystalline in fCNTGE.



Scheme 2.1 Proposed gelation mechanism of fCNT-PVA-KOH mixtures

Table 2.2 Calculated Thermal and Mechanical Properties, Ionic Conductivity, Transference Number, Specific capacity, and Energy

	GE	fCNTGE	GOG
T_d (°C)	150	202	189
ΔH_m (J/g)	271	167	270
Young's Module (kPa)	0.9	2.3	0.2
Tensile Strength (kPa)	9.3	22.3	5.8
σ (10^{-2} S cm^{-1})	5.1	6.9	6.2
Ionic Transference Number	0.55	0.90	0.87
Electronic Transference Number	0.45	0.10	0.13
Electrochemical Stability window (V)	3.04	3.6	3.02
Specific Capacity (C/20, mAh g^{-1})	205.4	204.3	108.3
Specific Energy (mWh g^{-1})	235.2	234.9	212.8

FTIR spectra were used to determine the interactions within PVA, GE, GOG and fCNTGE and results were displayed in Figure 2.3. All major peaks related to acetate and hydroxyl groups were observed. PVA exhibited strong stretching broad peaks of –OH groups at about 3200 cm^{-1} to strong intermolecular and intramolecular hydrogen bonds [131]. Peaks from C-O groups at about 1095 cm^{-1} and C-H wagging and stretching vibrations from alkyl CH_2 groups at 2937 cm^{-1} [132, 133] were observed. These peaks were also seen in the FTIR spectrum of GE, fCNTGE, and GOG which indicated the existence of bonds and functional groups. While an additional weak the absorption peak at about 1105 cm^{-1} in the fCNTGE spectrum can be attributed to the absorption of carboxyl C=O groups of the surplus MWCNT–COOH traces [129, 134], the band at 1365 cm^{-1} was associated with secondary bending vibration of O-H [135]. GO has a broad and strong deformation vibration -OH band at 1365 cm^{-1} due to extensive oxidation [136]. The peak at about 1729 cm^{-1} belongs to stretching of C–O and C=O from acetate group remains [137].

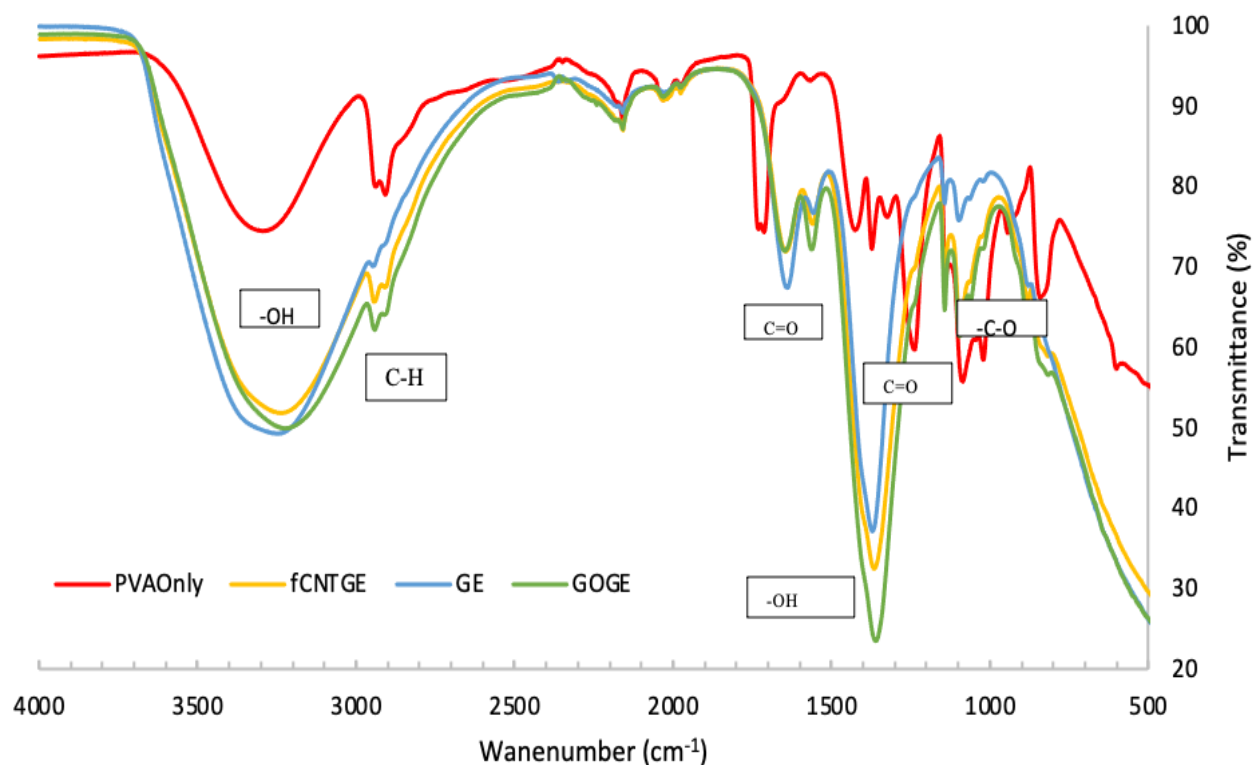

Figure 2.3 FTIR Spectra of pure PVA, fCNTGE, GE and GOG.

The peaks show the interactions between hydroxyl groups of the PVA macromolecule and carboxyl groups of CNTs. The complex structure between the PVA polymer, KOH and doped fCNTs could be verified with the peaks shifting and peaks intensity changes in the FTIR spectra such as stretching and bending vibration of O-H group. The intensity increases of stretching O-H and broadening bending vibration of O-H may confirm that the PVA monomers were polymerized and grafted successfully onto the GO and CNT fibers in the gel electrolyte.

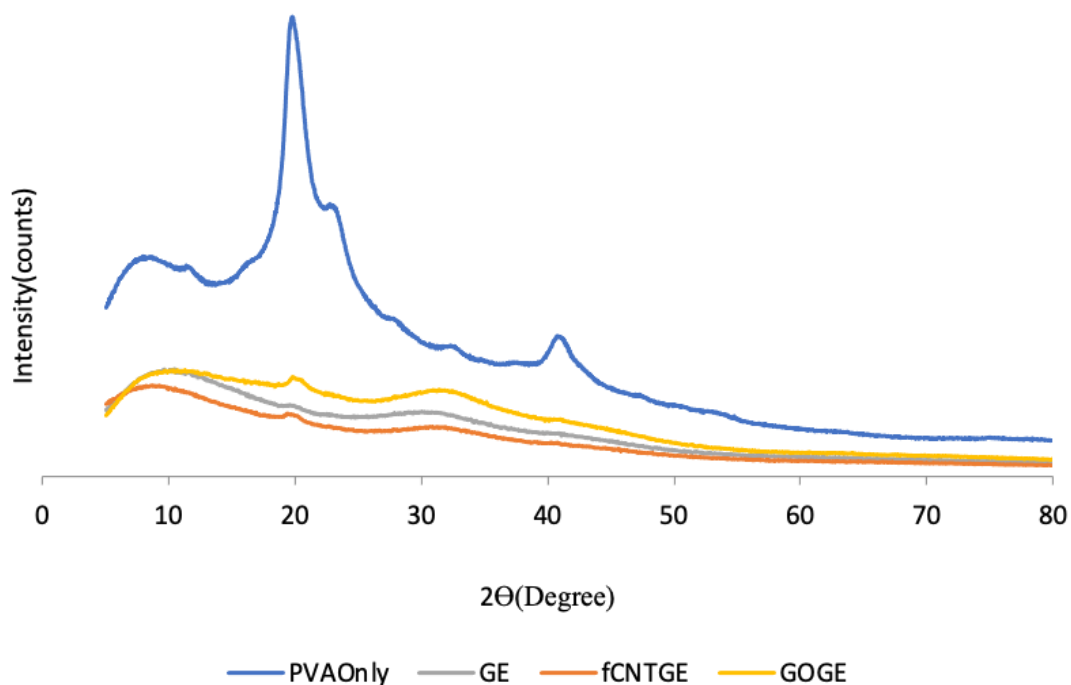

Figure 2.4 XRD patterns of pure PVA, GOG, GE, and fCNTGE.

The X-ray diffraction (XRD) characterization studies have been carried out to determine the crystallinity and phase structure of the PVA only, GE, GOG and fCNTGE polymer electrolytes. As shown in Figure 2.4., PVA shows a broad amorphous halo centered peak at the diffraction angles (2θ) value of 11.2° as well as a prominent peak at $2\theta = 19.4^\circ$ and $2\theta = 40.7^\circ$ for all samples, indicating the coexistence of mixed amorphous and crystalline regions. The amorphous peaks correspond to (100) and crystalline peaks (-101), (-111) orientation planes, respectively [138]. Also, the peak of $2\theta = 40.7^\circ$ is invisible for GE, GOG, and fCNTGE showing no other crystalline complex formed.

To improve the ionic conductivity and ion transport more easily, an amorphous characterization of gel electrolytes should be improved [101]. All crystalline peaks and amorphous peaks were expanded, and their intensities decreased sharply after the PVA was treated with KOH solution, GO and fCNT. The GE, GOG and fCNTGE samples displayed similar crystalline diffraction patterns but the intensity of fCNTGE peak was a little lower than GE and GOG implying that amorphous nature of fCNTGE increased compared with GE, GOG, and PVA only.

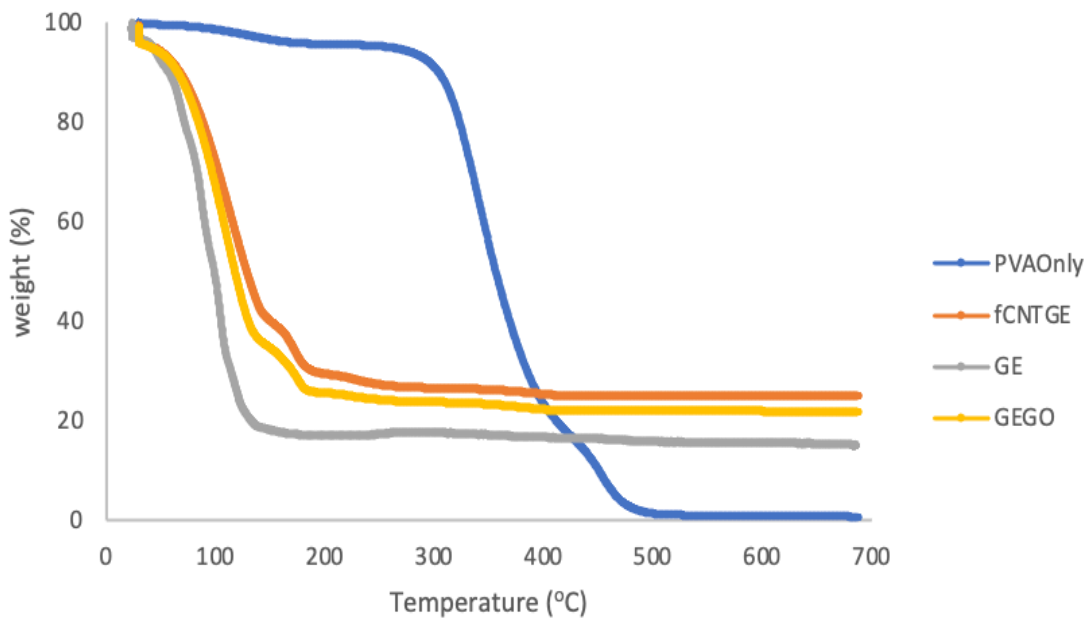

Figure 2.5 TGA curves of pure PVA, GE, GOG and fCNTGE.

The thermal behavior and stability of samples were investigated using thermogravimetric analysis (TGA) in Figure 2.5 and differential scanning calorimetry (DSC) in Figure 2.6. The initial weight loss (~5 wt.%) has occurred about 40 °C for GE, GOG, and fCNTGE, which may be due to the removal of electrolyte moisture. This result was compatible with others that stated water removal starts at lower temperature for PVA gel systems [139, 140]. The decomposition temperature of pure

PVA is ~ 350 °C. A weight loss for the GE which contains only KOH is observed at ~ 150 °C which is smaller than PVA only since complex form of $-\text{OH}$ groups in PVA backbone with salt cation causes a decrease in decomposition temperature [101, 141]. When fCNTs were added to the PVA-KOH gel electrolyte, the decomposition temperature and thermal stability of nanocomposite electrolytes increased from 150 °C to 206 °C and from 150 °C to 189 °C with adding GO (Table 2), which was high enough for potential applications such as electrolyte in energy storage devices.

The thermal stability and melting temperature (T_m) are important parameters to assess in-situ performance of the samples in the battery especially while the operating temperature is increased.

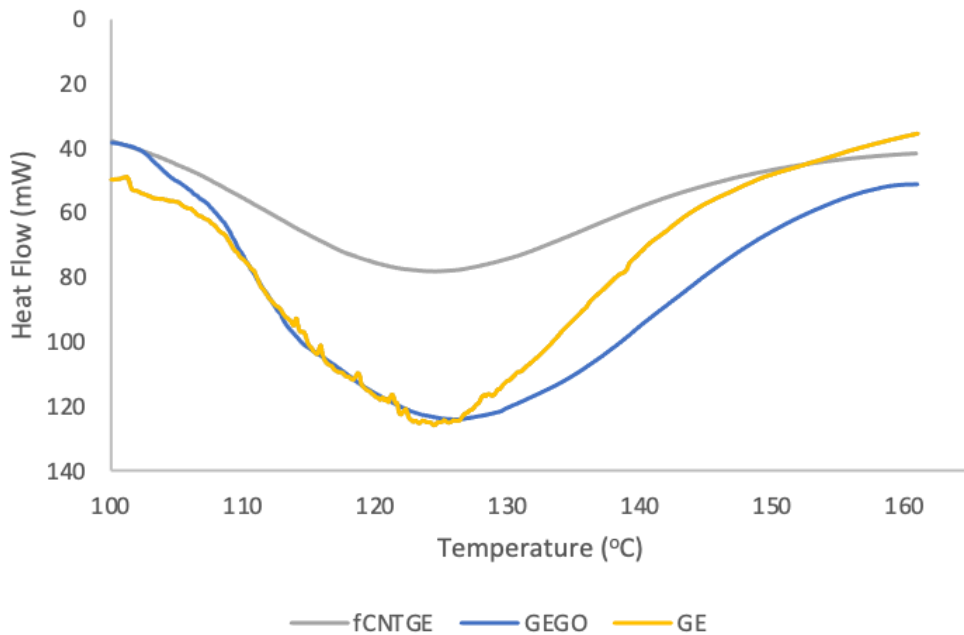

Figure 2.6 Differential Scanning Calorimetry (DSC) thermogram of GE, GOGO and fCNTGE.

GE exhibits a strong endothermic peak at around 126.4 °C. When fCNT were added, the melting temperature of GE shifted to slightly lower temperature from 126.4 °C to 124.9 °C. Also, the melting enthalpy value is reduced with introduction of fCNTs into GE, suggesting the addition of fCNT promote amorphicity in gel electrolyte.

2.3.2 Mechanical Properties of GE, fCNTGE, and GOG

GE, GOG, and fCNTGE were used as electrolyte and separator between electrodes in the battery fabrication process. Mechanical properties of polymer electrolytes based on rheological techniques play important roles to understand the relationship between internal structural changes and constitutional variations by an input stress.

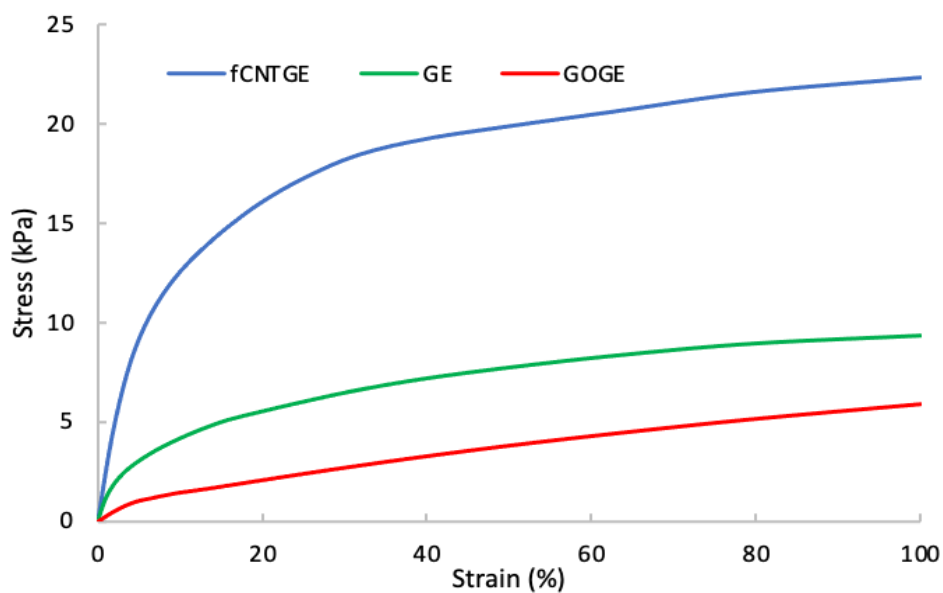

Figure 2.7 Stress-Strain curves of GE, GOG, and fCNTGE samples.

Typical stress-strain curves of GE, GOGGE and fCNTGE samples are shown in Figure 2.7. For mechanical tests, the samples were cast on a rectangular mold having dimensions for $5 \times 5 \times 2.5 \text{ mm}^3$ and then measured 4 times, with the average values calculated and reported here. fCNTGE exhibited higher mechanical properties such as Young's modulus calculated from the slopes of curves in the early stage of linear portion and ultimate tensile strength compared to GE and GOGGE. The Young's modulus and tensile strength was 2.3 and 22.3 kPa for fCNTGE, 0.9 and 9.3 kPa for GE, and 0.22 kPa and 5.8 kPa for GOGGE, respectively are shown in Table 2.2. The fCNTs had strong interaction with the PVA matrix and showed dramatic improvements over the pure PVA gel as well as GOGGE.

The viscoelastic mechanical properties of fCNTGE were further tested as a function of shear strain at constant frequency (1 Hz) and shown Figure 2.8. GOGGE was not tested further because it showed lower mechanical strength. It was observed that the dynamic mechanical properties of storage modulus (G') and loss modulus (G'') decreased with increase in shear strain indicating typical gel-like behavior [142]. G' dominated over the G'' , explained that the elastic properties dominated over the viscous properties till the crossover point. The G'' dominated the G' at high shear strain value by the fact that 3-D network of gel might be broken and consequently the viscous modulus was greater than the elastic modulus. In the GE, crossovers occurred at strain amplitudes of 0.5 % while the crossover of fCNTGE appeared at 1.5 %, which was about three times greater than GE.

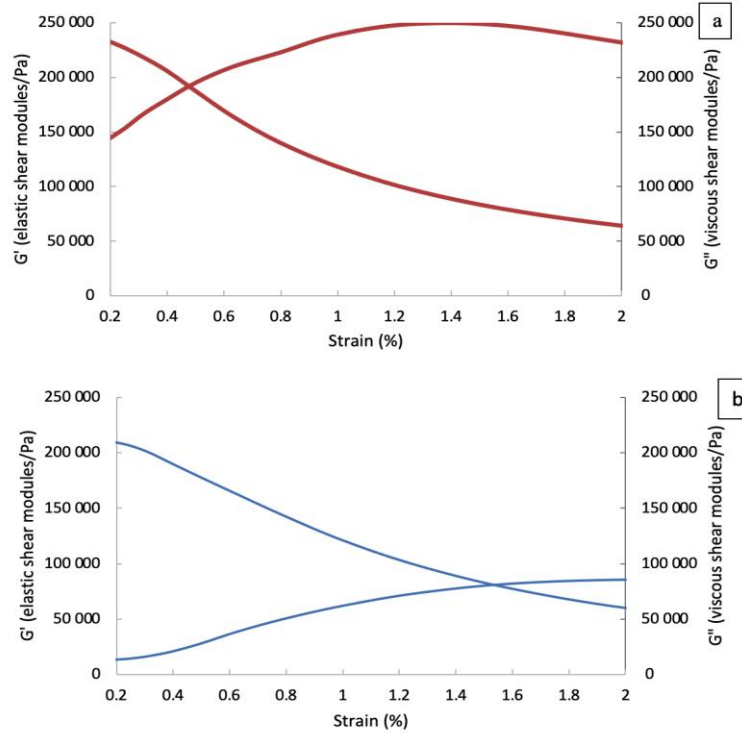

Figure 2.8 The Dynamic shear modulus of (a) GE and (b) fCNTGE with strain.

2.3.3 Electrical Properties of the GE, fCNTGE, and GOG

Electrochemical impedance spectroscopy (EIS) tests using two-electrode configuration was carried out at open circuit potential with AC potential amplitude of 5 mV, and the frequency ranged from 100 Hz to 1 MHz to evaluate the efficient ion migration channel of GE, GOG as well as fCNTGE. It was observed that the ionic conductivity of the PVA-KOH system was $5.1 \times 10^{-2} \text{ S cm}^{-1}$ (no fCNT content), lower than that of PVA-KOH-fCNTs (fCNTGE) system. When 17.5 mg of GO or fCNTs were introduced, the ionic conductivity values of the gel electrolytes increased to $6.2 \times 10^{-2} \text{ S cm}^{-1}$ for GOG and $6.9 \times 10^{-2} \text{ S cm}^{-1}$ for fCNTGE, according to the Equation. (2.1). The ionic conductivity of the gel electrolytes (σ , S cm^{-1}) was evaluated by the Nyquist plot representing the imaginary and the real part of the

impedance and calculated by the equation;

$$\sigma = \frac{L}{R_b * A} \quad (2.1)$$

where L (cm) is the distance between the two-platinum inner electrode, R_b (ohms) is the bulk resistance calculated from the point of intersecting with the x-axis, A (cm²) is the contact area of the electrolyte with platinum during the experiment.

From Figure 2.9, it can be seen that GE, GOG, and fCNTGE exhibit a small inclined line at the middle frequency, which is related to Warburg or diffusive resistance of ions in the bulk electrode. Conductivity is significantly improved by introducing fCNTs into PVA gel, revealing that the diffusion and transport of ions into electrolyte were much better than GE and GOG. It was explicit that R_b calculated from the point of intersecting with x-axis in the range of high frequency decreased with embedding fCNTs into the gel. The increase of conductivity can be explained as addition of the fCNTs promoting segmental motion of PVA grafted fCNTs, which ease ions to migrate in material.

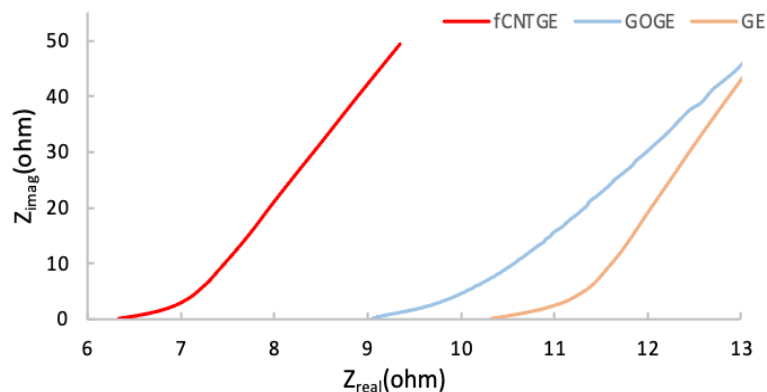

Figure 2.9 The Nyquist plots for the GE, GOG and fCNTGE.

The cyclic voltammetry (CV) behavior was compared for GE, GOG and fCNTGE at scan rate 50 mV s^{-1} in Figure 2.10a. Silver oxide electrode was used as a working electrode, platinum as a counter electrode, and Ag/AgCl as a reference electrode. The voltammogram showed well-defined anodic peaks at 0.33 V for GE and at 0.37 V for fCNTGE from the oxidation of silver (I) at 50 mV s^{-1} . The cathodic peaks at 0.19 V for GE, 0.23 V for fCNTGE, and 0.25 V for GOG were attributed to the reduction of silver (I).

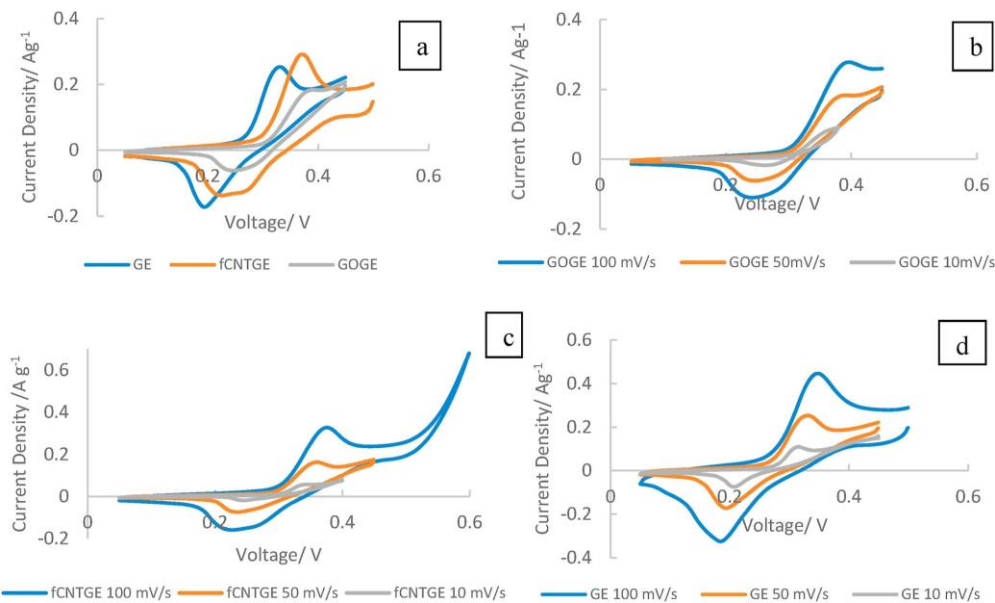

Figure 2.10 CV curves of a) GE and fCNTGE, at 0.05 mV s^{-1} scan rate; b) GE, c) fCNTGE, d) GOG with different scan rates.

The addition of fCNTs led to increase in the size of oxidation and reduction peaks, suggesting a better utilization of electrodes. Figure 2.10. b-d. Shows the CV curves for GE, GOG and fCNTGE at different scan rates from 10 to 100 mV s⁻¹. The electrode current density increased with scan rate and the shape of CV did not change considerably and exhibited acceptable electrochemical reversibility [95].

2.3.4 Transference Number and Electrochemical Stability Window Measurements

Transference number is an important parameter described as the ratio of the ionic conduction to the total charge transport. Here, the transference number of gel electrolytes was measured by chronoamperometry and calculated the residual electronic current passing through the electrolyte using Wagner's polarization technique [143, 144]. The stainless steel/gel electrolyte/stainless steel cells were polarized fully with a fixed DC potential of 1.5 V and the current flow passing through the cells was monitored as a function of time. The polarization current versus time plotted for GE, fCNTGE, and GOG was shown in Figure 2.11a. The following formulas was adopted to calculate transference number (t):

$$t_{\text{ion}} = \frac{I_T - I_e}{I_T} \quad (2.2)$$

$$t_e = \frac{I_e}{I_T} \quad (2.3)$$

$$I_T = I_i + I_e$$

where t_{ion} is ionic transference, t_e is electronic transference number. Initial total current

(I_T) can be defined as the sum of ionic (I_i) and electronic (I_e) currents. Electronic current I_e after polarization were measured as a final current. $I_T - I_e$

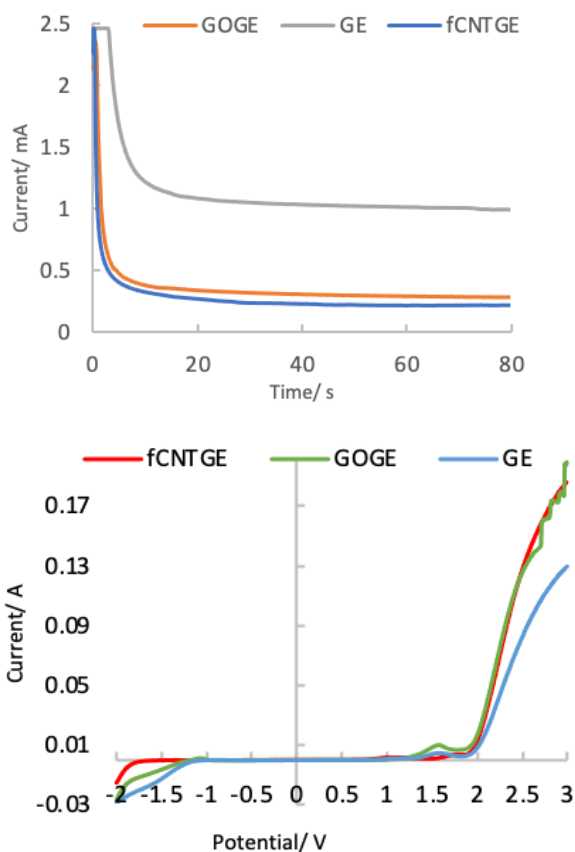

Figure 2.11 a) DC polarization curve; **b)** Linear sweep voltammograms at scan rate 0.05 mV/s for GE, fCNTGE, and GOG.

The ionic transference number of GE, GOG and fCNTGE was calculated as 0.55, 0.87 and 0.90, respectively. Both ionic and electronic transference numbers are shown in Table 2.2. The decrease in current with time in Figure 2.11a suggested that the total conductivity and charge transport in the electrolyte systems were predominantly due to ions, accompanied by mass transport [145] and electronic contribution could be neglected. T_{ion} gradually increased (up to 0.90) upon addition of fCNT nanoparticles. Consequently, this proved that KOH salt has provided OH^- ions as mobile species more in fCNTGE than GOG and GE.

One of the main drawbacks for aqueous electrolytes is the narrow electrochemical windows due to the electrolysis of water [146]. In order to determine the electrochemical stability window, linear sweep voltammetry (LSV) technique was conducted by a sweep voltammetry on the stainless steel/gel electrolyte/stainless steel cell configurations. A standard Ag-AgCl was used as the reference electrode. LSV was performed between 0 V and 3 V at a scan rate of 0.05 mV s^{-1} presented in Figure 2.11b.

As can be seen, the current flow was stable within the voltage range of approximately -1.72 to +1.9 for fCNTGE and -1.14 to +1.9 for GOG and GE and they begin to rise with continuous increase in voltage. Redox peaks for fCNTGE appeared at 1.3 V and it was relatively wide and weak. The onset of current flow which refers to anodic decomposition voltage [145, 147] starts at about 1.9 V which refers to OH^- anions. The cathodic voltage was observed for fCNTGE at -1.72 V, for GE at -1.14 V, and for GOG at -0.9V.

Thus, there is an improvement in the voltage stability window in fCNT-containing gel electrolyte which is ~3.6 V. The electrochemical stability window for GE was found ~3.04 V, and ~3.02V for GOG, shown in Table 2.2.

2.3.5 Galvanostatic Discharge (GCD) Analysis of GE, fCNTGE, and GOG

Crescent shape prototype batteries were fabricated using 3-dimensional printed (3D) acrylonitrile butadiene styrene (ABS) casings. In a typical cell, the silver oxide cathode, which was the limiting reagent, was firstly inserted in the casing. Then, the gellable electrolyte was poured onto the electrodes to fulfill the gelation reaction. In this way, the electrolyte could penetrate the vacancies of the electrode materials and exclude bubbles on the surfaces. Thus, the electrode-electrolyte interface can significantly improve. After that, zinc anode was added, and the components were capped to make it a cell (Figure 2.12d.).

The SEM images and the picture of electrodes are shown in Figures 2.1j-k and 2.12c., respectively. The performance of zinc-silver oxide batteries with GE, GOG and fCNTGE in a 3D printed system discharged at C/20 and C/10 was shown in Figure 2.12a-b. The specific capacity (C/20, calculated based on Ag_2O) and specific energy was displayed in Table 2.2. For the fCNTGE the curves showed more stable voltages than GOG and GE. The voltage plateau region for fCNTGE was to be higher than GE and GOG. Furthermore, the voltage plateau region for GOG and GE turned out to be less unstable and fluctuated especially for the case of GOG. One possible reason might be that GO got reduced by zinc, causing aggregation of graphene and short circuits.

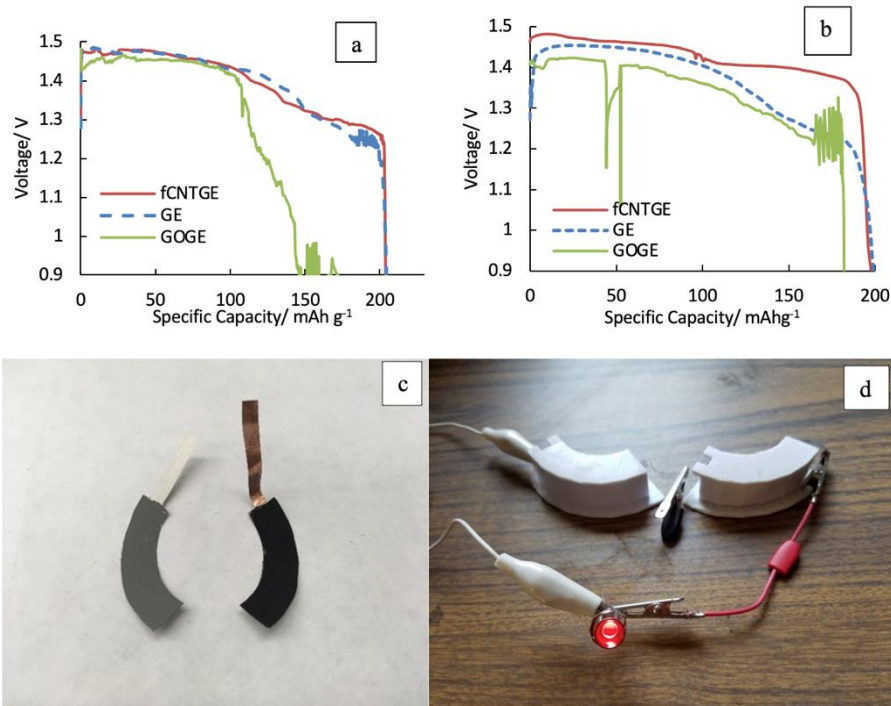

Figure 2.12 Discharge curves under different rates a) C/20, b) C/10; c) Zinc anode (grey) and silver cathode (black), d) 3D-printed Ag-Zn batteries.

2.4 Conclusion

A novel fCNTs gel electrolyte (fCNTGE) with PVA as the polymer matrix is prepared and tested inside Zn-Ag₂O batteries. The formulation was optimized with fCNTs having different degrees of functionalization. The results show improved ionic conductivity of PVA-KOH gel by doping fCNTs into the gel because of ionic channels provided by the fCNTs. The ionic conductivity of the GE (no fCNT content) system is $5.1 \times 10^{-2} \text{ S cm}^{-1}$. After the addition of GO (17.5 mg) or fCNTs, the ionic conductivity increases to $6.2 \times 10^{-2} \text{ S cm}^{-1}$ (GOG) and $6.9 \times 10^{-2} \text{ S cm}^{-1}$ (fCNTGE). A significant enhancement in the mechanical properties is also observed as the tensile strength increased to 22.3 kPa for fCNTGE which is 2.5-fold enhancement as compared to the GE and 3.5-fold enhancement compared to the GOG. The

electrochemical performance of the electrolytes is evaluated by the batteries using Zn-Ag₂O electrode material. Experimental results from the battery containing fCNTGE show more stable voltages, desired plateau region and promising application ability in the Zn-Ag₂O batteries.

CHAPTER 3

COMPUTATIONAL INVESTIGATION OF ENHANCED PROPERTIES IN FUNCTIONALIZED CARBON NANOTUBE DOPED POLYVINYL ALCOHOL GEL ELECTROLYTE SYSTEMS

3.1 Introduction

Although electrolytes with good interfacial stability are a crucial component of any electrochemical device, electrode materials accompanied by electrolyte decomposition or electrolytes' loss due to leakage can cause detrimental reactions in batteries. Liquid electrolytes have been used traditionally for a long time owing to their excellent electrochemical properties, but there are some disadvantages such as material defects [82], low operating temperature range [148] and the necessary encapsulation of a liquid [149] which are risky elements for cell operation. To this end, gel electrolytes (GE) utilizing a liquid phase in a solid polymer matrix are becoming widely studied for such systems because they have higher ionic conductivity than completely solid-state electrolytes while being safer and more compact than liquid ones and can be prepared in any configuration in soft casings [150].

Although GEs offer many improvements over solid polymer electrolytes, there are still enhancements to be made, such as increasing their ionic conductivity, mechanical properties, and thermal stability [151]. Using additives in GE systems is a wise strategy to improve their performance in electrochemical devices [152]. However, the nature of the interactions between the different electrolyte components and how they influence various properties such as ionic transport remains an area of active study [153].

In Chapter 2, the development of a hybrid GE consisting of functionalized carbon nanotube-doped poly (vinyl alcohol) (PVA) polymer and using 3D printed Zn-Ag₂O batteries was shown [154]. The potassium hydroxide (KOH) liquid electrolyte was trapped in the GE and COOH functionalized carbon nanotubes (fCNTs) were used as an additive to improve the hydrophilicity, ionic transport, and mechanical strength of the electrolyte. The influence of the fCNT additives in the GE was determined by electrochemical and mechanical characterization. However, questions remain about the atomistic origins of the enhancement of the properties in this system.

In this work, these questions through computational modeling of the interactions between fCNTs, PVA, and the working ion were answered. The nature of the interaction between PVA dendrimers, fCNTs, and Zn ions was investigated on the atomic level by using density functional theory (DFT) calculations.

First, by determining the adsorption energies, DFT calculations theoretically confirmed that PVA chains interact more strongly with fCNTs than non functionalized CNTs, likely partly contributing to the observed higher mechanical properties. It was demonstrated that this is due to enhanced charge transfer between the CNT and PVA as the number of functional groups increases. Next, it looked at trends in the HOMO-LUMO gap and how they are affected by the functionalization of the CNT. Finally, the interaction of Zn ions with the fCNT-GE complex was studied and found that the enhanced ionic conductivity is partly because the Zn ion does not adsorb strongly. These calculations allowed us to better understand the influence of CNT functionalization on the properties of GEs.

3.2 Computational Methods

Modern computational approaches can provide accurate energies of molecules and can be used to design and optimize new materials for energy storage devices [83]. Here, density functional theory (DFT) was utilized, in which the system of interacting electrons is mapped to non-interacting ones moving in an effective potential [155]. DFT provides valuable information on molecular geometries and properties and can be used to determine the electronic properties of compounds fast and accurately [84]. The adsorption processes of the Zn atom on pristine and fCNT loaded PVAs are investigated in this way. The DFT calculations were performed in the ORCA computational package [156]. The B3LYP functional was applied in this work to carry out all the computations. A def2-SVP functional was used for the CNT, while the def2-TZVP basis set was used on the COOH functional groups, PVA molecules, and Zn atoms [157]. This approach has been shown to be appropriate for studying the adsorption of compounds with H-terminated CNTs [158]. A D3BJ dispersion correction was used [159], along with a RIJCOSX approximation for Coulomb integrals [160]. A sample of the input file and output file of all samples was added to Appendix A and B.

A single-wall armchair (5,5) carbon nanotube terminated by hydrogen atoms was considered and the (5,5) SWCNT containing 70 carbon atoms and 20 hydrogen atoms was selected for this purpose. The diameter of the nanotube is 6.99 Å, the length of the nanotube is 7.34 Å, and the average C-C bond length is 1.42 Å. The most favorable adsorption position for PVA was determined by calculating the energy of a variety of configurations relative to the CNT and functional group and finding the lowest energy one. The adsorption binding energy was computed to measure the

adsorption energies (E_{ads}) of fCNT-PVA-Zn structures. In every case the ionic positions were fully relaxed with an energy convergence criterion of 5×10^{-5} Ha (NormalOpt in ORCA). To evaluate the interaction between the PVA molecule with the pristine CNT and fCNT, their adsorption energies (E_{ads}) were calculated using Equation 3.1 and Equation 3.2, respectively. It was defined as the energy difference between the adsorbed CNT-PVA or fCNT-PVA system and the isolated CNT species and PVA, and can be expressed as:

$$E_{\text{ads}} = E_{\text{CNTPVA}} - (E_{\text{PVA}} + E_{\text{CNT}}) \quad (3.1)$$

$$E_{\text{ads}} = E_{\text{fCNTPVA}} - (E_{\text{PVA}} + E_{\text{fCNT}}) \quad (3.2)$$

where E_{CNTPVA} is the total energy of the PVA molecule adsorbed on the pristine CNT, E_{fCNTPVA} is the total energy of the PVA molecule adsorbed on the functionalized CNT, E_{fCNT} is the total energy of the functionalized CNT, and E_{PVA} is the total energy of the PVA molecule. To estimate the interaction between the Zn molecule and fCNTPVA, their adsorption energy (E_{ads}), is calculated as Equation 3.3.

$$E_{\text{ads}} = E_{\text{fCNTPVAZn}} - (E_{\text{fCNTPVA}} + E_{\text{Zn}}) \quad (3.3)$$

where $E_{\text{fCNTPVAZn}}$ is the total energy of the Zn molecule adsorbed on the functionalized CNT and E_{Zn} is the total energy of the Zn molecule. A negative value of E_{ads} indicates a spontaneous process leading to a stable structure. With this definition, a negative binding energy shows that the binding interaction is favored, with a more negative

E_{ads} indicating a more favorable interaction.

The charge density and orbital interactions were evaluated using natural bond orbital (NBO) analysis and the JANPA code [161]. NBO was used to calculate the charge difference before and after adsorption of the Zn and PVA molecule on CNTs and fCNTs on the optimized structures. NBO analyses were also performed at the previously described level of theory for all atoms. Charge transfer is a key factor in the adsorption process to find if the adsorbate and functional groups act as electron donors or acceptors and how strongly the components interact. The charge transfer (ΔQ_e) is defined with Equation 3.4 and 3.5.

$$\Delta Q_e (\text{PVA}) = Q(\text{PVA})_{\text{after ads.}} - Q(\text{PVA})_{\text{before ads}} \quad (3.4)$$

$$\Delta Q_e (\text{Zn}) = Q(\text{Zn})_{\text{after ads.}} - Q(\text{Zn})_{\text{before ads}} \quad (3.5)$$

where $Q_{\text{after ads.}}$ is the total charge adsorbing on the CNT and fCNT surface and $Q_{\text{before ads}}$ is the total charge in the free case.

3.3. Results and Discussion

3.3.1 PVA Interaction with Pristine and Functionalized CNTs

CNTs have a structure formed with a hexagonal network of covalent sp^2 C-C bonds and a very high length-to-diameter ratio. For the solubilization of carbon nanotubes, the attachment of relatively large functional groups to the nanotubes is required. The functionalization breaks the nanotube bundles, which is essential to the solubility [162]. Since pristine CNTs are insoluble, functionalization enhances their solubility or dispersion [163, 164].

In a previous chapter, fCNTs were produced by microwave treatment of carbon nanotubes to alter the degree of the carboxylic terminal group (-COOH) [165]. The functionalization of CNTs introduced oxygen-containing groups, especially hydrophilic -COOH, leading to high aqueous dispersibility of the products [154]. It has also been previously reported that modification of CNTs leads to improved interactions with small molecules with considerable binding energy [166]. Moreover, the strength of the carbon-carbon bonds gives carbon nanotubes excellent mechanical properties [167]. As such, it was first studied the CNT structure with increasing numbers of functional groups. The optimized geometries of the computational models of the pristine CNT and functionalized CNT with 1, 2, and 3 COOH functional groups (denoted fCNT, ffCNT, and fffCNT, respectively) are displayed in Figure 3.1.

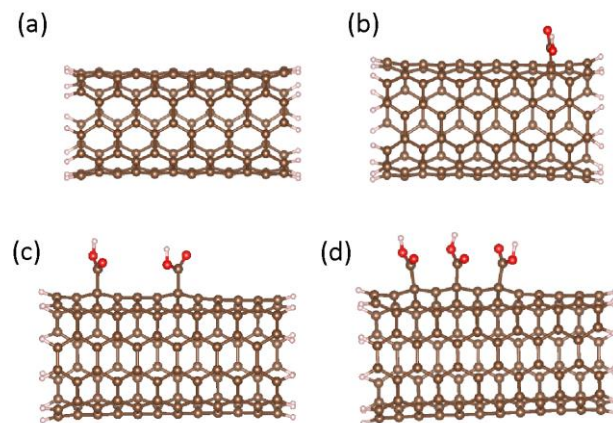

Figure 3.1 DFT Optimized Geometry for (a) CNT, (b) fCNT, (c) ffCNT, and (d) fffCNT.

In a GE, a polymer network is created in which a solvent and a salt are incorporated in a polymer matrix and rely on the well-documented ability of the repeating vinyl alcohol unit to coordinate alkali cations. Hence, both the polymer network and the solvent often contain PVA oligomer segments. In this study, two and three monomer ethanol (vinyl alcohol) $\text{CH}_2\text{CH}(\text{OH})$ matrixes have been adopted to determine how these PVA species interact with the $-\text{COOH}$ functional groups and coordinate the alkali cations. To determine the PVA interactions with pristine CNT, fCNT, ffCNT, and fffCNT, it was first adsorbed a one monomer polyvinyl alcohol (denoted $(\text{PVA})_1$) molecule on the surface of each structure (Figure 3a-d). It was also tested the effect of polymer length by adsorbing two and three monomer long molecules (denoted $(\text{PVA})_2$ and $(\text{PVA})_3$, respectively) on these different CNT structures. Figure 3.2e-h and Figure 3.2i-k show the optimized geometry of the CNTs with two and three PVA monomer chains, respectively. In each case it was computed the adsorption energy of PVA with the CNT substrate as described previously, the results of which are summarized in Table 3.1.

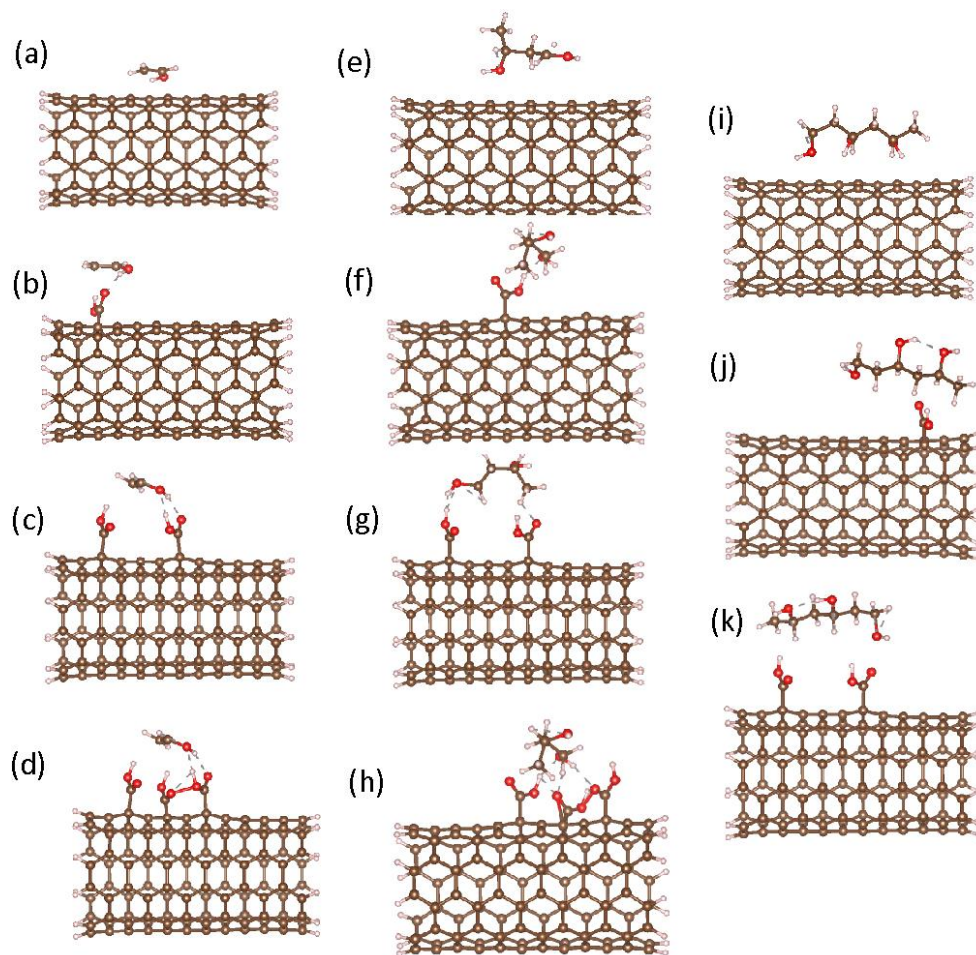

Figure 3.2 Optimized geometry of one monomer (PVA)₁ interaction with (a) CNT, (b) fCNT, (c) ffcCNT, and (d) ffcCNT; two monomer (PVA)₂ interaction with (e) CNT, (f) fCNT, (g) ffcCNT, and (h) ffcCNT; three monomer (PVA)₃ interaction with (i) CNT, (j) fCNT, and (k) ffcCNT.

Table 3.1 Adsorption energy (ΔE_{ads} , units of eV) of PVA and charge transfer (ΔQ_e , units of electrons, e) to PVA in each CNT-PVA complex.

Structure	ΔE_{ads} PVA (eV)	ΔQ_e PVA (e)
CNT-(PVA) ₁	-0.51	0.006
fCNT-(PVA) ₁	-0.67	-0.004
ffCNT-(PVA) ₁	-0.84	-0.001
fffCNT-(PVA) ₁	-1.52	0.011
CNT-(PVA) ₂	-0.72	0.019
fCNT-(PVA) ₂	-0.97	0.046
ffCNT-(PVA) ₂	-1.15	0.027
fffCNT-(PVA) ₂	-2.23	0.069
CNT-(PVA) ₃	-0.66	0.021
fCNT-(PVA) ₃	-0.52	0.007
ffCNT-(PVA) ₃	-1.40	0.049

On the pristine CNT, the PVA molecule orients horizontally with small adsorption energies ranging from approximately -0.5 to -0.7 eV, indicating some weak interaction between them. In the functionalized CNT cases, the PVA chain prefers to orient horizontally next to the -COOH group in almost every case. As the number of functional groups increase, ΔE_{ads} become more negative, indicating a stronger interaction with the PVA molecule regardless of the length of the PVA chain. Furthermore, the interaction between PVA and the functionalized CNTs becomes stronger as the chain length increases from one to two. Two monomer PVA on fffCNT provided the most negative interaction energies (Table 1) among all cases. Although three monomer PVA with three functional groups on CNT could not be employed because of computational infeasibility, the adsorption energy follows a similar trend on CNT, fCNT, and ffCNT. As expected, this indicates that increasing the number of functional groups on the CNT (such as through the aforementioned microwave process [165]) enhances its interaction with the PVA polymer matrix of the GE. These stronger interactions can contribute to the increased mechanical strength and thermal

stability of the fCNT-PVA system.

Then the charge transfer occurring between each CNT-PVA complex (Q_e , as defined previously) were computed to help explain these observed trends in adsorption energy. Because the -COOH functional groups act as electron withdrawing, the charge on the PVA is generally positive. In the (PVA)₁ case, the charge on the PVA does not change significantly until the case of three functional groups, at which point it jumps from near 0 to 0.01 e . In the (PVA)₂ and (PVA)₃ cases; however, more charge transfer is observed. In general, increasing the number of functional groups caused an increase in the amount of charge transfer from the PVA to the CNT substrate, similarly partially contributing to the observed increasing trends of the adsorption energies. The charge transfer from the PVA goes from 0.02 e to 0.04 e to 0.07 e as the number of functional groups goes from 0 to 1 to 3 in (PVA)₂ case, but the charge transfer is only 0.03 e for two functional groups, slightly bucking the trend. The charge transfer does not track exactly the trends in adsorption energy, but in general more charge transfer occurs for the (PVA)₂ and (PVA)₃ molecules as the number of -COOH functional groups increase. Moreover, the charge transfer in all cases is quite small, indicating that strong bonds are not formed between the PVA molecules and CNT structures.

The visualization of the charge density in these complexes (Figure 3.3) also corroborates these findings. The charge density of (PVA)₁, (PVA)₂ and (PVA)₃ on CNT with increasing number of functional groups are shown in Figure 3.3a-d, 3e-h, and 3.3i-k, respectively. From these figures, it is clear that as the number of functional groups increases, increasing amounts of charge density is present on both the COOH group and the surface of the CNT. Interestingly, in the case of ffCNT and fffCNT, it

appears that most of the charge is concentrated within one of the -COOH functional groups rather than split evenly between all of them. This implies that the interaction of the head group of the PVA molecule with one of the functional groups is most important in determining the adsorption properties.

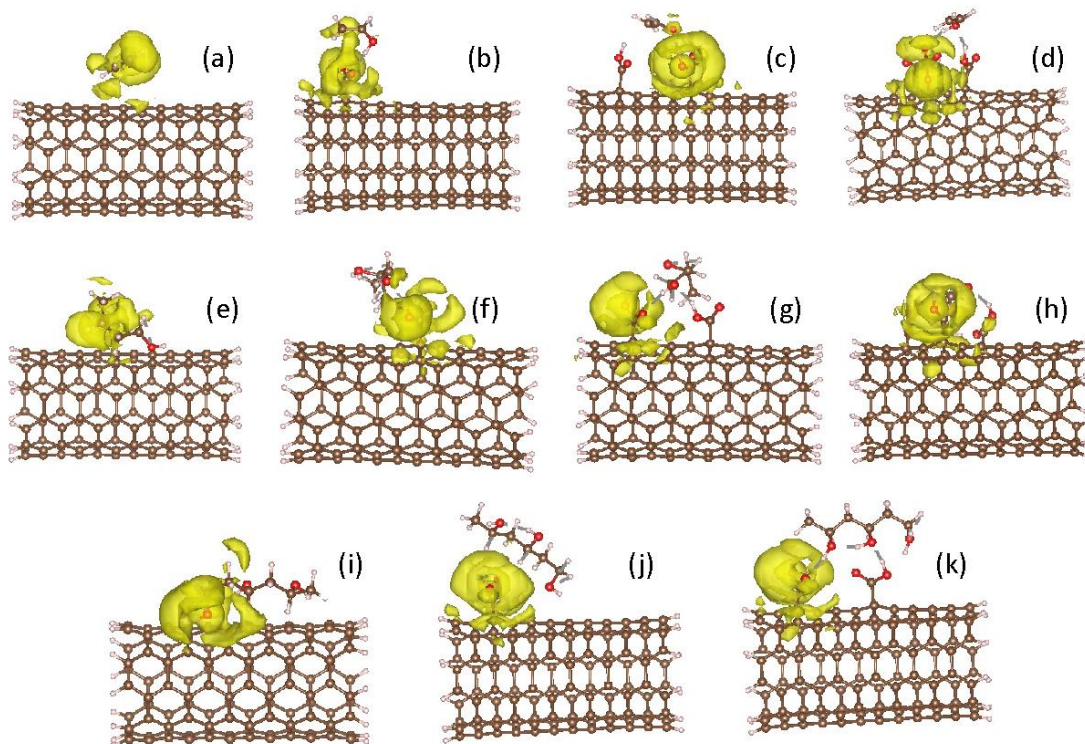

Figure 3.3 Electron density of (a) CNT-(PVA)₁, (b) fCNT-(PVA)₁, (c) ffCNT-(PVA)₁, (d) fffCNT-(PVA)₁, (e) CNT-(PVA)₂, (f) fCNT-(PVA)₂, (g) ffCNT-(PVA)₂, (h) fffCNT-(PVA)₂, (i) CNT-(PVA)₃, (j) fCNT-(PVA)₃, and (k) ffCNT-(PVA)₃.

Finally, the highest occupied molecular orbitals and lowest unoccupied molecular orbitals (E_{HOMO} and E_{LUMO}) in these complexes (Table 3.2) and the energy gap between them (E_g) were reported. Although DFT is well-known to underestimate the energy gaps, the overall observed trends in the gaps can still give useful insights. In agreement with previous computational results involving hydrogen terminated

CNTs, the systems in this study exhibited HOMO-LUMO gaps ranging from approximately 0.4 to 1 eV [158]. First, increasing the number of functional groups was observed to have the largest effect on the HOMO-LUMO gap. Increasing the number of functional groups from 0 to 1 and to 3 steadily increased the HOMO-LUMO gap from approximately 0.8 to 0.9 to 1 eV. However, the drop of gap to 0.4 eV needed to be investigated in the case of two functional groups. Next, increasing the number of monomers in the PVA chain were found little effect on the magnitude of the HOMO-LUMO gap in the case of fCNT, ffCNT, and fffCNT, which increases only 0.02 eV when increasing from (PVA)₁ to (PVA)₃. This was an expected result since there is no significant bonding between the CNTs and PVAs molecules although the adsorption energies between them is non-negligible.

Table 3.2. The Energy of the HOMO (E_{HOMO}), LUMO (E_{LUMO}), and HOMO-LUMO Gap (E_g) in Units of eV

Structure	E_{HOMO} (eV)	E_{LUMO} (eV)	E_g (eV)
CNT	-4.10	-3.32	0.78
CNT-(PVA) ₁	-4.06	-3.27	0.78
fCNT-(PVA) ₁	-4.19	-3.32	0.87
ffCNT-(PVA) ₁	-3.97	-3.54	0.43
fffCNT-(PVA) ₁	-4.45	-3.25	1.19
CNT-(PVA) ₂	-4.07	-3.26	0.80
fCNT-(PVA) ₂	-4.15	-3.31	0.84
ffCNT-(PVA) ₂	-3.95	-3.52	0.43
fffCNT-(PVA) ₂	-4.23	-3.17	1.06
CNT-(PVA) ₃	-4.18	-3.39	0.79
fCNT-(PVA) ₃	-4.16	-3.28	0.87
ffCNT-(PVA) ₃	-3.96	-3.55	0.41

3.3.2 Zn Ion Interaction with Pristine and Functionalized CNT-(PVA)_n Complexes

The other aspect of this study is the modelling of the coordination situation around the Zn ion in polymer gel electrolytes where amorphous long-chain PVA plays a central role. It is therefore interesting to investigate how Zn cations are coordinated to the solvent molecules and functionalized CNT and thereby gain insights about the vinyl-ion complex interaction in these systems. The DFT-optimized geometry of (PVA)₁, (PVA)₂, and (PVA)₃ with different functionalized CNTs and a Zn ion is shown in Figure 3.4a-c, 3.4d-f, and 4g-i, respectively. In each case, the lowest energy configuration for the Zn ion (Table 3.1) is to be coordinated to the COOH group with the PVA molecule above it. It was also found that the PVA chains and functionalized CNTs generally interact weakly with the Zn ions (an average of -0.4 eV), allowing for facile transport and likely partly contributes to the observed high ionic conductivity in this gel electrolyte. Indeed, the ΔE_{ads} for the Zn ion are significantly lower than that of any PVA molecule (Table 3.1). This small ΔE_{ads} are known to be needed to get good ionic conductivity in electrolytes [163].

Although favorable adsorption (*i.e.*, a negative ΔE_{ads}), is necessary for good ionic conductivity, too strong of interactions between Zn and the system can lead to immobilization of the ions in the electrolyte, preventing their movement. It is therefore important that E_{ads} of Zn is not so strong that the ions preferentially bind to the system and do not diffuse (in particular, not stronger than that of PVA).

Furthermore, in contrast to the PVA-only case, there is no significant trend in the adsorption energy for the Zn ion. The ΔE_{ads} of PVA in these complexes is similar or slightly higher compared to the case without the Zn ions. This indicates that the

introduction of Zn ions to the system does not significantly disrupt the interactions between the PVA and CNT, which is an ideal situation for a gel electrolyte system.

Table 3.3 Adsorption energy (ΔE_{ads} , units of eV) of PVA and charge transfer (ΔQ_e , units of electrons, e) to PVA with Zn and the energy of the HOMO (E_{HOMO}), LUMO (E_{LUMO}), and HOMO-LUMO gap (E_g) in units of eV in each CNT-PVA-Zn complex

Structure	ΔE_{ads}	ΔE_{ads}	ΔQ_e	ΔQ_e	E_{HOMO}	E_{LUMO}	E_g
	PVA (eV)	Zn (eV)	PVA (e)	Zn (e)	(eV)	(eV)	(eV)
CNT-(PVA) ₁ -Zn	-0.87	-0.36	-0.002	0.026	-4.19	-3.40	0.78
fCNT-(PVA) ₁ -Zn	-0.84	-0.17	-0.040	0.086	-4.23	-3.36	0.87
ffCNT-(PVA) ₁ -Zn	-1.23	-0.39	0.050	0.059	-4.05	-3.58	0.47
fffCNT-(PVA) ₁ -Zn	-	-	-	-	-4.09	-3.22	0.86
CNT-(PVA) ₂ -Zn	-1.09	-0.37	0.020	0.030	-4.19	-3.42	0.78
fCNT-(PVA) ₂ -Zn	-1.06	-0.08	-0.010	0.061	-4.24	-3.37	0.86
ffCNT-(PVA) ₂ -Zn	-1.84	-0.69	0.063	0.077	-3.96	-3.52	0.44
CNT-(PVA) ₃ -Zn	-1.21	-0.55	0.014	0.035	-4.04	-3.25	0.79
fCNT-(PVA) ₃ -Zn	-1.47	-0.95	0.003	0.079	-4.18	-3.32	0.86
ffCNT-(PVA) ₃ -Zn	-1.50	-0.10	0.018	0.069	-3.94	-3.48	0.46

The charge transfer to the PVA molecule (ΔQ_e) and Zn ion on various functionalized CNTs were investigated. As before, the -COOH species act as electron withdrawing groups, imparting a slight positive charge to both adsorbates. In each case, the charge transfer from the Zn ion to the functional group is larger than from the PVA molecules; this is expected since the lowest energy configuration occurs with the Zn ion closest to the -COOH group. Furthermore, the charge transfer on the Zn ion on fCNT and ffCNT is 2 to 4 times larger than on the pristine CNT, as in the case of PVA alone. However, there is no clear trend for the adsorption energy of PVA molecules in combination with Zn, likely due to the fact that now there are interactions to consider with both the Zn ion and the functionalized CNTs. Moreover, the PVA molecules are closer to the Zn ion than to the actual CNT surface. Finally, as with the

pure PVA case, adding Zn ions to the system does not significantly change the HOMO-LUMO gap (Table 3.3). As described before, the Zn ion does not interact strongly with the functionalized CNT-PVA systems, and as such little change in the HOMO-LUMO gap is to be expected.

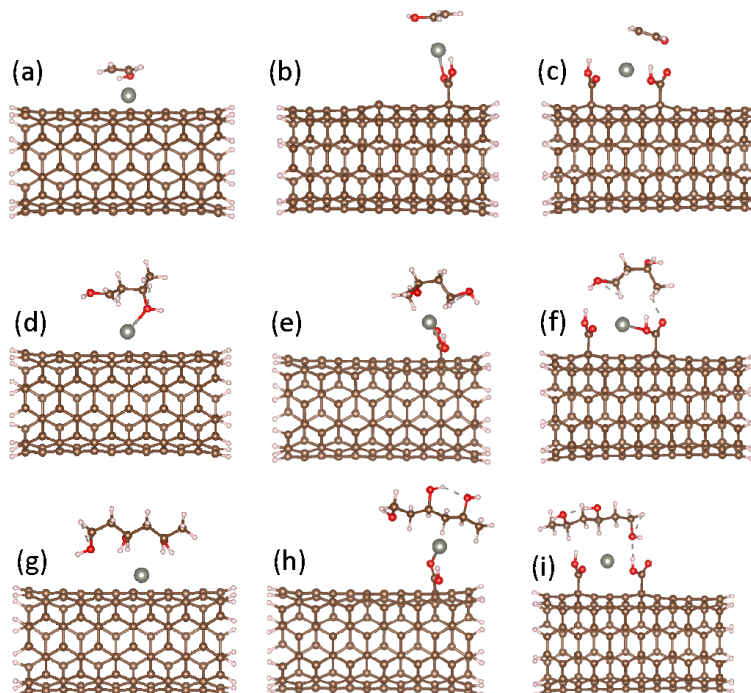

Figure 3.4 The adsorption configuration of a Zn ion with a (a) CNT-(PVA)₁, (b) fCNT-(PVA)₁, (c) ffCNT-(PVA)₁, (d) CNT-(PVA)₂, (e) fCNT-(PVA)₂, (f) ffCNT-(PVA)₂, (g) CNT-(PVA)₃, (h) fCNT-(PVA)₃, and (i) ffCNT-(PVA)₃ complex.

3.3.3 Discussion

It was now placed our results in the broader context of gel electrolyte systems with additives. Although the atomic level interactions between the electrolyte components contribute to the electrolytes' characteristics, it was recognized that the extended structure of the CNT-polymer network is also critically important; unfortunately, such studies are well beyond the scope of the type of DFT calculations performed here. For

example, in addition to the additives, the cross-linking of the polymer chains also contributes significantly to the mechanical properties and transport properties [168]. Furthermore, low E_{ads} for Zn ions is not the only requirement for increased ionic transport, as non-functionalized CNTs have been shown to increase the ionic conductivity in GEs by creating a 3D conducting network in the electrolyte [169]. In this work, functionalizing the CNT with -COOH groups is observed to increase the interactions with PVA while not affecting the interactions with Zn, which can contribute to the observed enhanced properties.

The mechanical properties of composites rely on the dispersion state of fillers, alignment, a high aspect ratio, and interfacial interactions between the CNTs and the polymer matrix. Physical and chemical functionalization of CNTs has been shown to enhance the interfacial adhesion, the modulus, and strength as well as fracture resistance of nanocomposites. DFT remains one of the most efficient methods of quantitatively predicting and rationalizing the mechanical properties for materials. Our experimental results in a previous study showed that a significant enhancement in the mechanical properties in terms of the Young's module ($E = 2.3$) and tensile strength (22.3 kPa) of fCNTGE which was 2.5-fold higher than a typical GE. Although these mechanical properties cannot be calculated directly using this implementation of DFT, it can be described how these enhancements are influenced by the interactions between various components (*i.e.*, through E_{ads}). DFT calculations confirmed that PVA chains interact more strongly with fCNTs than unfunctionalized CNTs and the interaction between PVA and the functionalized CNTs becomes stronger as the chain length increases from one to two to three. The increase in charge transfer with the number of functional groups are attributed to increase adsorption

energies and consequently better mechanical properties.

Furthermore, low E_{ads} for Zn ions is not the only requirement for increased ionic transport, as non-functionalized CNTs have been shown to increase the ionic conductivity in GEs by creating a 3D conducting network in the electrolyte [Fan, 2020 #112]. In this work, functionalizing the CNT with -COOH groups was observed to increase the interactions with PVA while not affecting the interactions with Zn, which can contribute to the observed enhanced properties.

3.4 Conclusion

In summary, the nature of interaction between PVA dendrimers, functionalized carbon nanotubes, and Zn ions is investigated at the atomic level using DFT. The most favorable adsorption positions for PVA are determined by calculating the energy of a variety of configurations relative to the CNT and functional group and finding the lowest energy one; similar calculations were then performed for Zn-PVA complexes. DFT calculations theoretically confirm that various monomers of PVA interact with non-functionalized CNT but more strongly as the number of functional groups increased (i.e., enhancing ΔE_{ads}). Then, it is investigated the effect of polymer length by adsorbing two and three monomers long PVA on the different CNT structures. The interaction between PVA and the functionalized CNTs becomes stronger as the chain length increases from one to two to three. The increase in charge transfer with the number of functional groups likely results in these increased adsorption energies and better mechanical properties. Finally, it is demonstrated that a Zn ion weakly adsorbs to the CNT-PVA complex, which is good for ionic conductivity. Furthermore, Zn does not disrupt the interactions between the PVA and functionalized CNTs. These

insights into this gel electrolyte system can explain the atomic level reasons for the observed experimental properties.

CHAPTER 4

COMPUTATIONAL STUDY OF ADSORPTION OF WATER POLLUTANTS ON A FUNCTIONALIZED CARBON NANOTUBE-BASED MEMBRANE

4.1 Introduction

Water and air are the most important factors for life and every organism on Earth depends on them. Unfortunately, these resources are in danger due to continued industrial growth and the advancement of technology causing discharge of pollutants into the environment [170]. The contamination of water and air by pollutants causes harmful effects in the human body and results in both short- and long-term problems [171]. Some contaminants are from geological materials in nature [172] and some of them are man-made by-products of industry [41]. Although some contaminants can be detected by odor, color, and taste, most require testing if water or air is contaminated or not followed by removal. Recent solutions to remove the contaminants from the environment include various treatment methods such as adsorption [173], ion exchange [174], and membrane technology [175]. Of these, membrane technology has gained interest because it can be processed in mild conditions using low energy with requirement of relatively small size equipment and it can be used with other separation techniques together [176, 177]. However, there are also downsides such as low lifetime, concentration of polarization, and fouling [178, 179].

Among recent materials, CNTs have played an important role as sorbents for selective solute transport in different membrane applications which have promoted higher flux, selectivity, and reduced fouling of the system [44, 45]. It was observed

that immobilization of CNTs on membrane surfaces has a great effect on the interaction between the membrane and solutes [46-48]. CNTs' surface areas are between 100 and 1000 m²/g [49] which make them excellent candidates as sorbents. However, CNTs display high water permeability and good adsorptive capabilities [50], they also have some disadvantages such as weak van der Waals interaction [51], insolubility for adsorbing of materials in aqueous solutions [52], and agglomeration [53].

Recently, CNTs functionalized by oxygen containing functional groups such as –COOH or –OH groups have become particularly promising materials for such applications as they are easily synthesized using oxidative treatments [54] enhance adsorptive capabilities [41] and improve solubility [55]. For example, such functionalized CNTs have been used in membranes for water desalination [180, 181], and removal of pollutants such as heavy metals [182], organic dyes [183] and endocrine disrupting chemicals [184]. In two recent studies, bare CNT and those functionalized with –COOH groups (denoted from here on as fCNT) immobilized membranes were used for both ammonia and methyl tert-butyl ether (MTBE) separation from water, and the fCNT immobilized membrane showed significantly better performance than bare CNT [45, 185]. The influence of the fCNT additives in the membrane was evaluated by mass transfer coefficients, selectivity, and flux [45]. The fCNT immobilized membrane showed extraordinary transport and adsorption of solutes, higher selectivity, and flux, as well as enhanced separation of organic solvents from water [185].

Density functional theory calculations (DFT) were used to understand how –COOH functionalized CNTs bind to and interact with these pollutants and investigate

if the same trend for different pollutants would be seen, as well. Our studied contaminants include a variety of atmospheric and aqueous pollutants, specifically mercury (Hg), nitric oxide (NO), ozone (O₃), sulfur dioxide (SO₂), peroxyacyl nitrate (PAN), ammonia (NH₃), polytetrafluoroethylene (PTFE), perfluorooctanoic acid (PFOA), and perfluorooctanesulfonic acid (PFOS). The nature of the interaction between the pollutants and bare and fCNTs were studied on the atomic level by using DFT calculations. First, by determining the adsorption energies, calculations confirmed that these pollutants interact more strongly with fCNTs than non functionalized CNTs, likely partly contributing to the observed improved properties such as mass transfer coefficient, selectivity, and flux. It was demonstrated that this is due to enhanced charge transfer between the CNT and pollutants as the number of functional groups increases. It was also looked at trends in the HOMO-LUMO gap and how they are affected by the functionalization of the CNT. These calculations allowed us to better understand the influence of CNT functionalization on the properties of membranes.

4.2 Methods

The adsorption processes of the water pollutants on CNT and fCNT loaded membranes are investigated using density functional theory (DFT), which provides valuable information on molecular geometries and electronic properties of compounds [84]. The DFT calculations were performed in the ORCA computational package [166]. The B3LYP functional was applied in this work to carry out all the computations. A def2-SVP basis set was used for the C and H atoms in the CNT, while the def2-TZVP basis set was used on pollutants and -COOH functional groups, an appropriate approach for studying the adsorption of compounds with H-terminated

CNTs [158]. A D3BJ dispersion correction was used to include van der Waals interactions [168], along with a RIJCOSX approximation for Coulomb integrals [169].

Presented results are based on a single-wall armchair (5,5) (SWCNT) carbon nanotube terminated by hydrogen atoms. The (5,5) SWCNT contains 70 carbon atoms and 20 hydrogen atoms. The diameter of the nanotube is 6.99 Å, the length of the nanotube is 7.34 Å, and the average C-C bond length is 1.42 Å. One and two carboxyl functional groups were attached to a carbon on the external surface of the CNT based on experimental functionalization; it was denoted these systems as fCNT and ffCNT, respectively.

The most favorable adsorption position was determined by calculating the energy of a variety of configurations of each pollutant relative to the CNT and functional group and finding the lowest energy one. In every case the ionic positions were fully relaxed with a convergence criterion of 5×10^{-5} Ha (NormalOpt in ORCA). To evaluate the interaction between samples with the pristine CNT and fCNT, their adsorption energies (E_{ads}) were calculated using Equation. (1) and Equation. (2), respectively. Adsorption energy (E_{ads}) is the change in energy that occurs when an adsorbate interacts with a surface. A negative value of E_{ads} indicates a spontaneous process leading to a stable structure. With this definition, a negative binding energy shows that the binding interaction is favored, with a more negative E_{ads} indicating a more favorable interaction. It is expressed as the energy difference between the adsorbed CNT or fCNT system and can be defined for each system as:

$$E_{\text{ads}} = E_{\text{system}} - (E_{\text{CNT}} + E_{\text{pollutant}}) \quad (4.1)$$

$$E_{\text{ads}} = E_{\text{system}} - (E_{\text{fCNT}} + E_{\text{pollutant}}) \quad (4.2)$$

where E_{system} is the total energy of the water pollutant molecules adsorbed on the bare CNT and fCNT, E_{CNT} is the total energy of the functionalized or non-functionalized CNT, E_{fCNT} is the total energy of the functionalized CNT, and $E_{\text{pollutant}}$ is the energy of the pollutant molecule.

The solvation energy is calculated based on the following Equation 4.3.

$$E_{\text{sol}} = E_{\text{system}} - (E_{\text{CNT}} + E_{\text{pollutant}}) \quad (4.3)$$

$$E_{\text{sol}} = E_{\text{system}} - (E_{\text{fCNT}} + E_{\text{pollutant}}) \quad (4.4)$$

The charge density and orbital interactions were evaluated using natural bond orbital (NBO) analysis and the JANPA code [83]. NBO was used to calculate the charge difference before and after adsorption of the water pollutant molecules on CNTs and fCNTs on the optimized structures. NBO analyses were also performed at the previously described level of theory for all atoms. Charge transfer is a key factor in the adsorption process to find if the adsorbate and functional groups act as electron donors or acceptors and how strongly the components interact. The charge transfer (ΔQ_e) is defined with Equation 4.5.

$$\Delta Q_e(\text{pollutant}) = Q(\text{pollutant})_{\text{after ads.}} - Q(\text{pollutant})_{\text{before ads.}} \quad (4.5)$$

where $Q_{\text{after ads.}}$ is the total charge adsorbing on the CNT and fCNT surface and Q_{before}

q_{ads} is the total charge in the free case.

Moreover, the HOMO/LUMO gap (E_g) is resulted as the Equation 4.6.

$$E_g = E_{LUMO} - E_{HOMO} \quad (4.6)$$

E_{LUMO} and E_{HOMO} signify the energies of the Lower Unoccupied Molecular Orbital and Higher Occupied Molecular Orbital.

The effect of an aqueous environment was included by a conductor-like polarizable continuum model (CPCM) as implemented in ORCA. A dielectric constant of 80.4 was used to simulate water.

4.3 Results and Discussion

4.3.1 Pollutant interactions with functionalized CNT in gas phase

The strength of the interactions between bare CNT and CNT functionalized with multiple -COOH groups with the various aforementioned pollutants were investigated. First, the atomic positions of a bare CNT, and CNT with one and two -COOH groups (fCNT and ffCNT respectively) were fully optimized. Next, the interaction of each pollutant with CNT, fCNT, and ffCNT was investigated by determining the most energetically favorable configuration in each case; this is summarized in Figure 4.1 (non-PFAS pollutants) and Figure 4.2 (PFAS pollutants) which show the corresponding lowest energy CNT/pollutant configuration after structural optimizations. Generally, most of them prefer to orient horizontally next to the functional group (-COOH) in almost every case except PFOS and PFOA with ffCNT configuration.

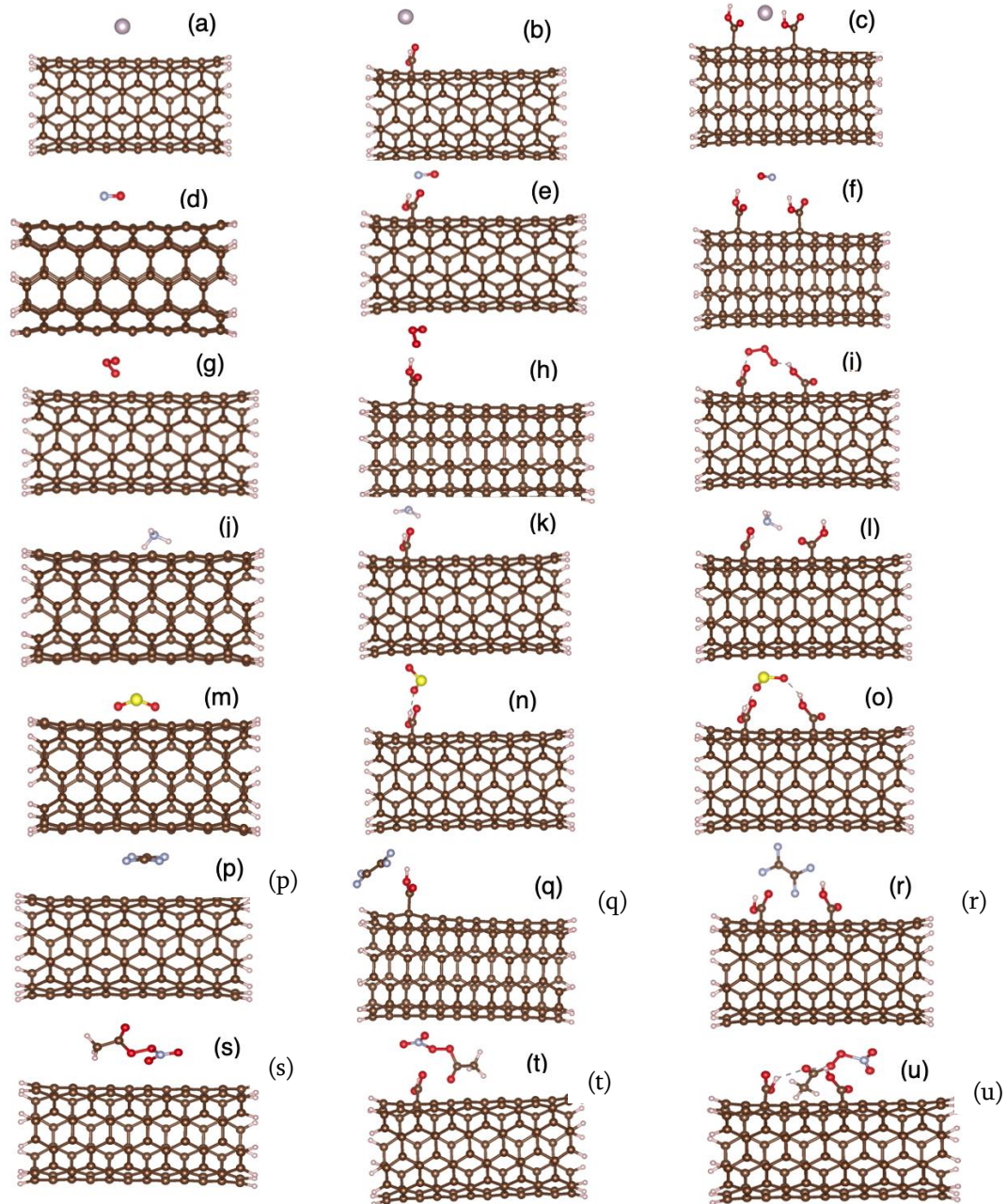

Figure 4.1 DFT optimized geometry for (a) CNT-Hg, (b) fCNT-Hg, (c) ffCNT-Hg (d) CNT-NO, (e) fCNT- NO, (f) ffCNT-NO, (g) CNT-O₃, (h) fCNT-O₃, (i) ffCNT-O₃, (j) CNT-NH₃, (k) fCNT- NH₃, (l) ffCNT- NH₃ (m) CNT-SO₂, (n) fCNT-SO₂, (o) ffCNT-SO₂ (p) CNT-PTFE, (q) fCNT-PTFE, (r) ffCNT-PTFE (s) CNT-PAN, (t) fCNT- PAN, (u) ffCNT- PAN.

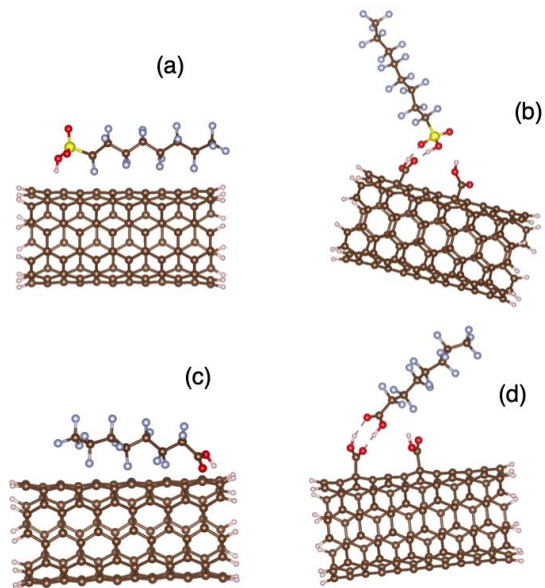

Figure 4.2. DFT Optimized Geometry for (a) CNT-PFOS (b) ffCNT-PFOS (c) CNT-PFOA (d) ffCNT-PFOA.

Table 4.1 Adsorption (ΔE_{ads}) and Solvation Energies (ΔE_{sol}) (units of eV) of Samples and Charge Transfer (ΔQ_e), (units of electrons)

Structure	ΔE_{ads} (eV)	ΔE_{sol} (eV)	ΔQ_e (e)
CNT-NO	-0.23	-0.24	-0.009
fCNT-NO	-0.06	-0.06	0.006
ffCNT-NO	-0.49	-0.42	0.018
CNT-SO ₂	-0.41	-0.39	-0.052
fCNT-SO ₂	-0.60	-0.37	-0.039
ffCNT-SO ₂	-0.88	-0.56	-0.110
CNT-O ₃	-0.45	-	-0.235
fCNT-O ₃	-0.69	-	-0.222
ffCNT-O ₃	-0.90	-	-0.385
CNT-Hg	-0.24	-0.24	-
fCNT-Hg	-0.15	-0.08	-
ffCNT-Hg	-0.38	-0.35	-
CNT-PAN	-0.72	-0.59	0.007
fCNT-PAN	-0.83	-0.63	0.006
ffCNT-PAN	-0.87	-0.59	0.020
CNT-NH ₃	-0.22	-0.17	0.008
fCNT-NH ₃	-0.38	-0.24	0.044
ffCNT-NH ₃	-0.89	-0.26	0.096
CNT-PTFE	-0.37	-0.35	0.020
fCNT-PTFE	-0.38	-0.33	0.008
ffCNT-PTFE	-0.47	-0.26	0.028
CNT-PFOS	-0.82	-0.66	0.624
ffCNT-PFOS	-1.30	-	-0.105
CNT-PFOA	-0.85	-0.78	0.002
ffCNT-PFOA	-1.25	-	0.004

In total, twenty-five different adsorption configurations were investigated in this work (nine pollutants with bare CNT, fCNT, and ffCNT). A stable optimized configuration and bonding is achieved by a favorable functionalization which keeps the system together. As expected, the adsorption of each pollutant on the functionalized CNTs occurred near the carboxyl group above the surface of CNT. The adsorption energy values are presented at Table 4.1. All the calculated adsorption energies are negative, indicating spontaneous adsorption on the surface. The more

negative the adsorption energy leads to the stronger adsorption between the CNTs and the pollutant molecule. On bare CNT, Hg, NO, and NH₃ are the weakest binding pollutants all with similar E_{ads} of only -0.23 to -0.24 eV, in agreement with the fact that non functionalized CNT is not very good at NH₃ separation. Next, PTFE, SO₂, and O₃ bind slightly more strongly, each with E_{ads} of approximately -0.4 eV. Finally, PAN, PFOS, and PFOA are the strongest binding pollutants to bare CNT, with E_{ads} ranging from -0.72 to -0.85 eV. These weaker interactions between the pollutants with bare CNT are unlikely to provide chemisorption; this is a well-known problem with adsorbate interactions with bare CNT surfaces [186].

With the introduction of -COOH functional groups on the CNT, much stronger adsorption energies were found, and the results showed that the functionalization of CNTs with -COOH molecules leads to stronger adsorption of some adsorbents. The three most weakly binding adsorbents on bare CNT (NH₃, NO, Hg) remained the most weakly bound after the introduction of one functional group; of these, only NH₃ increased by any significant amount (from -0.22 to -0.38 eV) but remains relatively weak. Interestingly, this agrees with the previously mentioned experimental observation that functionalization helps in removal of NH₃ [45]. This puts the adsorptive capability of fCNT towards NH₃ on the same level as PTFE. In this case, however, E_{ads} of PTFE only increase by 0.01 eV on fCNT. For SO₂, O₃, and PAN, E_{ads} increased in each case by 0.1 to 0.2 eV, indicating stronger binding of these pollutants upon functionalization.

Finally, in contrast to fCNT, the introduction of a second -COOH group increased the interaction strength of the CNT with all pollutants. Hg and PTFE remained the most weak bound, although both of their E_{ads} increased by approximately 0.1 eV. Both NH_3 and NO became more strongly bound as well, with the E_{ads} of NH_3 increasing by nearly 0.5 eV, again in agreement with the increase in NH_3 removal ability. Moreover, another study showed how functionalization of CNT with oxygen-based groups increases its interactions with NOx species, also in agreement with these results [187]. SO_2 and O_3 became more strongly bound by 0.1 eV. Interestingly, the adsorption energy of PFOS and PFOA became significantly more negative at -1.25 and -1.3 eV, respectively.

4.3.2 Pollutant Interactions with Functionalized CNT in Aqueous Phase

Next, the adsorption of each pollutant molecule with CNT, fCNT and ffCNT were investigated by re-optimizing the geometries in an implicit aqueous environment, as assessing the impact of solvent at the pollutant-liquid interface is required to predict numerous interfacial processes. The solvated adsorption energy (E_{sol}) was calculated using Equation. (3)-(4) and results are presented for different complexes in Table 1. Negative values of E_{sol} signify the stability of the studied complexes in the aqueous medium and show that adsorption remains a spontaneous process. In general, all the calculated adsorption energies become weaker when an implicit aqueous medium is included in the simulations. On bare CNT, the only significant change observed was for PAN, PFAS, and PFOS, for which the solvation environment resulted in a weakening of E_{sol} compared to E_{ads} by around 0.1 eV. E_{sol} of all the other pollutants remained within 0.01 or 0.02 eV of their E_{ads} value on CNT. Furthermore, the ranking

of all the pollutants by their solvated adsorption energy (E_{sol}) matches that of the non-solvated one (E_{ads}).

However, the situation changes on the functionalized CNTs. On fCNT, the adsorption energy of NO remains very weak while Hg is nearly halved in the solvation environment. For each of the other compounds E_{sol} decreases only slightly; interestingly, NH_3 shows the largest decrease in agreement with experimental results that functionalization of CNT improves its adsorptive properties towards this molecule. Finally, the presence of two $-\text{COOH}$ groups strongly affects the adsorption of NO, SO_2 , and Hg, the E_{sol} of which decreases by around 0.2 eV each. The E_{sol} of the other pollutants is not strongly affected by this further functionalization, decreasing only by 0.01 to 0.02 eV. These results show that, although functionalization of CNT improves its adsorptive capability in an aqueous environment, especially towards NH_3 and Hg, the effect is not as strong as in the gas phase; also, although it improves NO and SO_2 adsorption, these compounds typically form nitric acid and sulfurous acid in water and so would likely not be present.

4.3.3 Charge Transfer in the Pollutant-functionalized CNT Systems

The charge transfer from pollutants to CNT, fCNT, and ffCNT were investigated since it influences the adsorption strength of molecules to surfaces. Generally, increasing the number of functional groups causes an increase in the amount of charge transfer from the pollutants to the membrane, contributing to the observed increasing trends of the adsorption energies. From the calculated charge transfer (ΔQ_e , Table 1), it can be observed that some of the molecules behave as electron donors and others behave as electron acceptors. One bare CNT, ΔQ_e of the three weakest binding

pollutants (NH₃, PAN, and NO) are nearly 0. As expected, the absolute magnitude of the charge transfer increases for the next set of more strongly binding pollutants, PTFE ($\Delta Q_e = 0.02e$), SO₂ ($\Delta Q_e = -0.05e$), and O₃ ($\Delta Q_e = -0.24e$). Interestingly, the charge density for the two most strongly binding pollutants (PFOS, and PFOA) show a different trend. The ΔQ_e for PFOA is very weak ($\sim 0.002e$) while that of PFOS is significant ($0.62e$). This shows that, while important, charge transfer is not the only factor affecting adsorption. It could not be gotten any results in terms of charge transfer for Hg pollutants owing to the different basis set required for use on Hg.

On fCNT, the charge transfer of NO and PAN remained very weak ($0.006e$) while NH₃ increased to $0.04e$. This likely leads to the observed increase in the adsorption energy when compared to bare CNT. The charge transfer values for SO₂ and PTFE decreased on fCNT while it did not change for O₃ significantly. With the introduction of ffCNT, all pollutants' charge transfer value has shown increase while the highest negative value ($\sim -0.4e$) was seen on O₃ and the lowest value ($0.004e$) belongs to the PFOA. On the other hand, SO₂, NH₃, and PFOS have relatively higher increases with approximately $\sim 0.1e$, in agreement with the observed increase in E_{ads} for these compounds when adding a second functional group. PAN and PTFE have weaker increases in the charge transfer value with $\sim 0.02e$. For PAN and PTFE this is somewhat expected as E_{ads} only decrease by 0.04 eV and 0.09 eV, respectively. For NO, the charge transfer becomes three times larger ($0.006e$ to $0.018e$), correlating with its substantial increase in E_{ads} (-0.06 eV to -0.49 eV) when going from one to two functional groups on the CNT.

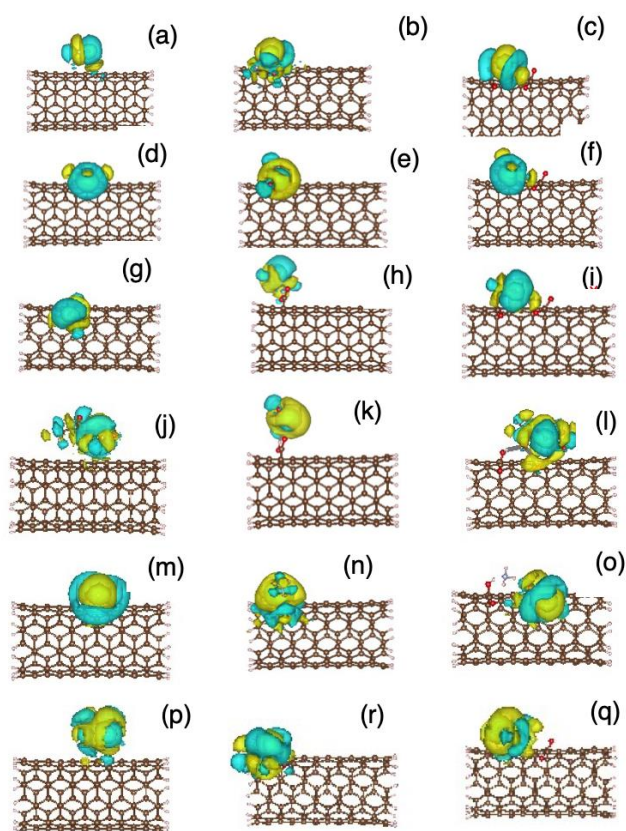

Figure 4.3 Electron density of (a) CNT-NO, (b) fCNT- NO, (c) ffCNT- NO, (d) fCNT- SO₂, (e) ffCNT- SO₂, (f) CNT- SO₂, (g) CNT-O₃, (h) fCNT-O₃, (i) ffCNT-O₃, (j) CNT-PAN, (k) fCNT-PAN, (l) ffCNT-PAN (m) fCNT-NH₃, (n) ffCNT-NH₃ (o) ffCNT- NH₃, (p) CNT-PTFE, (r) fCNT-PTFE, (q) ffCNT-PTFE.

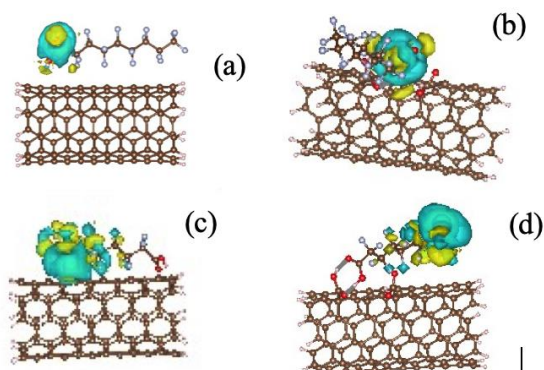

Figure 4.4 Electron Density of (a) CNT-PFOS (b) 90°ffCNT-PFOS (c) CNT-PFOA (e) 90° ffCNT-PFOA.

4.3.4 HOMO-LUMO

The energy of the highest occupied molecular orbitals (E_{HOMO}) and lowest unoccupied molecular orbitals (E_{LUMO}) were computed. While HOMO defines electron donating behavior of composite, LUMO defines its electron accepting behavior. That means higher E_{HOMO} shows greater electron donating capacity and lower E_{LUMO} values indicates easier electron accepting capacity [188]. E_{HOMO} and E_{LUMO} values and the energy difference between the HOMO and LUMO orbitals (HOMO-LUMO gap, E_g) were reported for the bare CNTs, fCNTs, and ffCNTs models in Table 4.2. Energy gap values displayed a zigzag pattern because of possible effects of curvature character of nanotubes. Previously, it was shown that band gap decreases with decreasing diameter of nanotubes with saw tooth-like periodicity and functionalizing with carboxyl can cause a change in diameter [55].

Table 4.2 The energy of the HOMO (E_{HOMO}), LUMO (E_{LUMO}), and HOMO-LUMO gap (E_g) in units of eV

Structure	E_{HOMO} (eV)	E_{LUMO} (eV)	E_g (eV)
CNT-NO	-4.17	-3.33	0.84
fCNT-NO	-3.87	-3.55	0.32
ffCNT-NO	-4.11	-3.31	0.80
CNT-SO ₂	-4.05	-3.67	0.38
fCNT-SO ₂	-4.17	-3.30	0.87
ffCNTSO ₂	-3.92	-3.52	0.40
CNT-O ₃	-4.19	-3.43	0.76
fCNT-O ₃			
ffCNT-O ₃	-4.03	-3.61	0.42
CNT-Hg	-4.14	-3.35	0.78
fCNT-Hg	-4.18	-3.31	0.87
ffCNT-Hg	-3.98	-3.54	0.44
CNT-PAN	-4.15	-3.37	0.78
fCNT-PAN	-4.10	-3.23	0.87
ffCNTPAN	-3.92	-3.50	0.42
CNT-NH ₃	-4.14	-3.33	0.81
fCNT-NH ₃	-4.19	-3.32	0.87
ffCNTNH ₃	-4.00	-3.57	0.43
CNT-PTFE	-4.07	-3.28	0.79
fCNT-PTFE	-4.11	-3.30	0.81
ffCNTPTFE	-3.95	-3.52	0.43
CNT-PFOA	4.13	3.34	0.79
CNT-PFOS	4.12	3.34	0.78
ffCNTPFOA	4.01	3.57	0.44
ffCNTPFOS	3.92	3.49	0.43

Unlike the previous chapter in which the HOMO-LUMO gap followed some general trends, in this case the gap does not seem to follow such nice trends. However, it can be made some general observations. On raw CNT, most of the adsorbates (NO, NH₃, PFOS, PTFE, PAN, Hg, and O₃) result in a similar gap of approximately 0.8 eV while the other two (PFOA and SO₂) both have gaps of nearly half that (approximately 0.4 eV). However, the magnitude of the gap does not correlate with either the

adsorption energy or amount of charge transfer; as such it is more useful to look at changes in E_g only between the same adsorbates as the number of functional groups increase. However, one interesting point is that even though PFOS and PFOA have the same adsorption energy, the E_g of PFOS is 0.79 eV while that of PFOA is 0.44 eV; this increase for PFOS is likely due to the fact that it withdraws charge from the CNT ($0.624e$) while PFOA does not ($0.002e$).

When a carboxyl functional group is introduced, the gaps with NH_3 , PAN, PTFE, and Hg all slightly increase by an average of 0.08 eV from raw CNT to fCNT. The lack of change is likely since the E_{ads} of these species do not substantially change (see discussion in section 4.3.1). In the case of SO_2 the gap increases from 0.38 eV on raw CNT to 0.87 eV on fCNT; there is also an increase in the adsorption energy from -0.41 eV on raw CNT to -0.60 eV on fCNT. With NO, the gap decreases substantially from 0.81 eV to 0.32 eV while the adsorption energy also decreases from -0.23 eV to -0.06 eV. It is interesting to note that it would be expected the HOMO-LUMO gap to decrease as interactions between the adsorbate and CNT become stronger (*i.e.*, as E_{ads} becomes more negative; it will be shown this is the case for ffCNT), which is the opposite observation for SO_2 and NO on fCNT, a discrepancy that deserves further study.

Upon introduction of a second functional group, the band gaps of NH_3 , PAN, PTFE, and Hg now show substantial changes, all decreasing to nearly the same value of 0.43 eV; in each of these cases, this drop corresponds to an increase of E_{ads} to more negative values. On ffCNT the gap of SO_2 follows a similar trend, decreasing to 0.40 eV with E_{ads} becoming more negative at -0.88 eV; however, as noted above, this is opposite to what is observed when going from CNT to fCNT. Interestingly, NO

behaves differently again while following the same trend it did when going from CNT to fCNT, with the band gap increasing from 0.32 eV to 0.8 eV from fCNT to ffCNT even though there is an increase in E_{ads} from -0.06 eV to -0.49 eV. Finally, it is interesting to note that the gaps of ffCNT with PFOS and PFOA did not change by any significant amount (0.01 eV) from the raw CNT values. Therefore, while most pollutants show somewhat expected trends in the HOMO-LUMO gap with E_{ads} , the anomalous case of NO deserves more study.

4.4 Conclusion

In this chapter, the ability of -COOH functionalized to adsorb different pollutants in gas phase and aqueous phase was investigated by computing adsorption energies, charge transfer, and HOMO-LUMO gaps. It was found that increasing the number of functional groups increases the strength of the interactions with the pollutants. Furthermore, the interactions are weakened when an implicit solvation model is introduced, indicating weaker adsorption in water. Then the adsorption strength to the charge transfer between the adsorbates and functionalized CNTs were correlated. Finally, it was shown how changes in the HOMO-LUMO gap can also correlate with changes in adsorption strength, with strong adsorption generally resulting in decreases in the gap, although adsorption of NO does not seem to follow this trend. Overall, these results provide a better understanding of the nature of the interaction of functionalized CNTs with air and water pollutants of interest for environmental remediation.

APPENDIX A

INPUT FILE FOR ffCNTPVAZn

The ORCA Input file contains a collection which show how to easily do various tasks using the many methods and approximations. As an example, the input file of ffCNTPVAZn sample is given.

```
! B3LYP def2-SVP D3BJ Grid6 NormalSCF OPT
%pal
nprocs 64
end
* xyz 0 2
  C -5.56862271827512 -3.03355309006887 0.31460723186575
  C -5.97545549765809 -1.72591093514917 0.18947153591340
  C -6.66301511362273 -1.07372839385368 1.26257104951459
  C -7.80438599983512 -0.20938732688249 1.03054497231901
  C -8.30890548239467 0.04112152950760 -0.28398087923140
  C -9.66433909027711 0.07087703784138 -0.51829337062243
  C -10.59069650145748 -0.14801614072196 0.54993359921481
  C -11.77302982677024 -0.97703384630448 0.38303767414981
  C -12.06731081818148 -1.63164988620393 -0.85203455748189
  C -12.51541962075827 -2.93351882631777 -0.85967591786606
  C -12.68756729898634 -3.64939182559221 0.36611272420262
  C -12.25257042245414 -5.03467253562823 0.50507312046806
  C -11.65386179475551 -5.74728893499457 -0.57299152947026
```

C	-10.56339039508741	-6.56649481285024	-0.35834900057497
C	-10.01511501300034	-6.71322872318728	0.94924163970201
C	-8.58255909924856	-6.75183307431477	1.18894698055117
C	-7.63632633194382	-6.62325259258494	0.12493336173239
C	-6.51635502000266	-5.83824825777076	0.27691080443812
C	-6.28566529697021	-5.13584211900176	1.50184846730994
C	-5.82316018976643	-3.76130414990149	1.52025184475239
C	-6.06436404142376	-2.99328138518278	2.69164486524009
C	-6.49527993584183	-1.62794913159630	2.55916717805176
C	-7.12589933568046	-1.00459986082326	3.68903877471211
C	-8.24877172614386	-0.16694350447401	3.46186909313850
C	-8.69506164318531	0.02875490745230	2.11338247995198
C	-10.10969872395995	0.06520323181089	1.86690823140137
C	-11.00007765306920	-0.09394772046852	2.98602231665565
C	-12.16300052331989	-0.88486569906578	2.81888708889100
C	-12.37961123815712	-1.51566807255993	1.54902639209281
C	-12.84282575388209	-2.87498665353830	1.54127939996296
C	-13.04859630247631	-3.52104634197318	2.81575705833972
C	-12.59686499987135	-4.87360984991849	2.94940147744885
C	-11.99385279677100	-5.51734296311043	1.81680577869218
C	-10.86394600005287	-6.37506418441969	2.04092514739471
C	-10.39856561469020	-6.55679719847484	3.38534212973534
C	-8.99591737271683	-6.60173816199472	3.62127949453342

C	-8.11513190652243	-6.45459878757480	2.49808017612257
C	-6.94645461636622	-5.63348987713181	2.65756447855303
C	-6.73020030524960	-5.00381902147254	3.92991194295668
C	-6.28319247431043	-3.65570702140598	3.94541368019167
C	-6.47038457986099	-2.88382656237458	5.13531933173304
C	-6.90479337224757	-1.52419085232924	5.00203073323601
C	-7.53025398129576	-0.89495077841965	6.11741968788665
C	-8.67088024304226	-0.05921858791831	5.88581424013537
C	-9.12948286647888	0.11943921303058	4.55562479297383
C	-10.54216153941994	0.15835885527272	4.31174016231794
C	-11.45111648962676	0.01443372612577	5.40947479534075
C	-12.66666253699338	-0.69856955993689	5.20969798078170
C	-12.85801123142115	-1.35350799191772	3.97944957809069
C	-13.28849854001526	-2.74567942746943	3.97430317771963
C	-13.42023611167165	-3.39550313068946	5.24353159237054
C	-12.97462546744005	-4.74649914633099	5.37469602370380
C	-12.38236934080024	-5.39905612807405	4.25157556476917
C	-11.27052004309402	-6.27734937066800	4.47847443657226
C	-10.80635546873079	-6.46757114474553	5.81377857633989
C	-9.39635092648444	-6.51180440666397	6.05329610401243
C	-8.51240275876908	-6.35883359540621	4.94338668213465
C	-7.34576279401633	-5.54005277512774	5.10393901306797
C	-7.12261035502224	-4.90999635921400	6.36437681896350

C	-6.67343023183414	-3.54936238970368	6.37817262482468
C	-6.88385725050087	-2.77247717562335	7.56423667188774
C	-7.32220896068563	-1.42381229687678	7.42784721050386
C	-7.95800467112719	-0.79162702864774	8.54706466806880
C	-9.08711182231408	0.03473794322972	8.32067394485039
C	-9.56804050385309	0.20264113285827	6.97677783416681
C	-10.96149418434588	0.24877292055951	6.73656790976941
C	-11.85212255822643	0.07891665788171	7.86480437280282
C	-13.03686868739440	-0.62728842280430	7.71887248506035
C	-13.56295255808922	-1.11093635205795	6.37661322731392
C	-13.66516703248975	-2.64105804283419	6.41889004185867
C	-13.82431469977352	-3.28530510827068	7.64839475786172
C	-13.39093196955948	-4.64324614283775	7.79220370232698
C	-12.78227598399850	-5.28615599801945	6.68080590030817
C	-11.67722309964975	-6.17021710505208	6.90869680129356
C	-11.21828706367399	-6.34749999079501	8.24338082748706
C	-9.81017958088316	-6.39441308078093	8.48685022343490
C	-8.91980720436139	-6.24917271177007	7.37883975666659
C	-7.75836489451097	-5.43052591690415	7.53717252975028
C	-7.54282045160377	-4.79061010346976	8.79822978600214
C	-7.09198343406537	-3.43736802274298	8.81297890340110
C	-7.30495825688430	-2.65951186611979	9.99743105156908
C	-7.73846063820575	-1.31332936805844	9.86406339043378

C	-8.34290913219319	-0.67244546996327	10.99244342190445
C	-9.48257651645330	0.17397206336966	10.76521308942961
C	-9.95809885931912	0.32192296974690	9.42277547492215
C	-11.35513219354286	0.34910874199045	9.19475201913980
C	-12.23159354044737	0.23729838433103	10.31572594168948
C	-13.41160295771985	-0.56756639289491	10.16194170316322
C	-13.65158429363667	-1.17287505182723	8.89163718992774
C	-14.08132307720759	-2.52426288738535	8.86127903719953
C	-14.30097227169586	-3.19593135417358	10.09401236594989
C	-13.85083465999808	-4.56455303562658	10.22901374550475
C	-13.19974666187058	-5.17487400191570	9.10512131753364
C	-12.09307120612429	-6.03238560609892	9.33544653894327
C	-11.64767183879328	-6.22311106265717	10.68238722959800
C	-10.23149661677372	-6.26325895569441	10.92795314095057
C	-9.34356534693034	-6.11519876416719	9.81078226074747
C	-8.18750646948677	-5.30494433677659	9.96989498650366
C	-7.96434092318547	-4.67901906172389	11.24009352185937
C	-7.50643483007107	-3.31626769687760	11.25419491459311
C	-7.67161355435946	-2.54157599975205	12.43788805357623
C	-8.09820330850005	-1.17286186206252	12.30325062689615
C	-8.69574391504164	-0.45068402719061	13.39285547188691
C	-9.77980517832620	0.35889321927440	13.17821032114595
C	-10.33891333630463	0.49359321304593	11.85944019225505

C	-11.75553830582693	0.52633487333147	11.62894026837973
C	-12.70545723468668	0.40000978113936	12.70406005302567
C	-13.81880435328052	-0.38312214718111	12.55836793095424
C	-14.05621570460619	-1.08444456761003	11.32209115091282
C	-14.53104484120423	-2.43658398044624	11.28447665593723
C	-14.80500792852986	-3.18039015681016	12.48908787215544
C	-14.39547452198947	-4.47918350505117	12.60415165677577
C	-13.68020004156377	-5.11443197429522	11.52194374747907
C	-12.53825742208003	-5.96501275805705	11.76186025199041
C	-12.03526835815114	-6.20448882129439	13.08367940130526
C	-10.68333934486647	-6.23870291795962	13.31911002136908
C	-9.75226465598266	-6.03170082872582	12.24697746088012
C	-8.57224251299898	-5.21599472338709	12.40929121924254
C	-8.26568396883655	-4.56688847695748	13.65243501043821
C	-7.82516451677415	-3.26813781689450	13.66737119698436
H	-5.19004594615921	-3.55503566075323	-0.56639622955826
H	-5.90635003161859	-1.24256115946043	-0.78664666372270
H	-7.62626809017287	0.05733233061591	-1.13548770845025
H	-10.02124315200456	0.10817559395729	-1.54912740446659
H	-11.79065618985128	-1.16355986750556	-1.79848762658078
H	-12.58046641954097	-3.46193729161212	-1.81241033722958
H	-11.94888095171782	-5.52843715396060	-1.60083759895220
H	-10.03052764570846	-6.96834122920109	-1.22191936721530

H	-7.87385351057012	-7.01579236186767	-0.86551794927433
H	-5.89579568108743	-5.62954283797158	-0.59636657891624
H	-8.37584514404281	-0.65052186350507	14.41719081281867
H	-10.30113839467792	0.78905380496648	14.03516460389222
H	-12.47050551163131	0.81178843978706	13.68719682246183
H	-14.44957921856723	-0.58422904400164	13.42568669674598
H	-15.21913041807568	-2.66749532126089	13.35914691499485
H	-14.49747250491383	-4.99112391773626	13.56255448511052
H	-12.72086753968699	-6.21748141933596	13.93267953797099
H	-10.32581459405408	-6.27423137098705	14.34967000969146
H	-8.52081664407056	-5.05172532664954	14.59653430086721
H	-7.73943544147205	-2.74665918123637	14.62232701386310
C	-14.95581243948730	-0.45002059935842	6.21603487438176
O	-15.15983152254003	0.69369785322757	6.60898304122714
O	-15.87634476559959	-1.23026560926592	5.70665330728090
H	-16.77402593405502	-0.86637263684527	5.92773964414191
H	-20.36747609128270	4.32840506414259	7.98648902457097
H	-19.37924967980798	5.97937599087599	9.07932004275759
C	-19.81724330733993	4.11849497532757	8.91101438780190
O	-19.08155988813484	5.13645568011856	9.44441295874544
C	-19.39903235585187	2.76206713625897	9.27362692052981
H	-18.34472071388514	2.56281182806875	8.87432033456827
H	-20.05620031539676	2.02427481033366	8.78689881594304

C	-19.35081218979027	2.49230712333844	10.79510238163177
O	-20.63166323190758	2.66422509001632	11.36403280484722
H	-20.97685776831999	3.50229665425350	11.02409035195181
H	-18.62947802045174	3.21473715527711	11.23276891053600
H	-17.99596876717272	0.88806900463973	10.42316764838184
C	-18.85711615155426	1.08117460730247	11.08072464727666
H	-19.64531315240929	0.36084397582644	10.80184587733128
C	-18.40605850439496	0.79005427814081	12.50828604475397
H	-17.72223131291724	1.61003463344044	12.82065647815256
O	-19.54598489047940	0.75691285867622	13.34854937554246
H	-16.73247838921280	-0.49427118398458	11.94836977276155
C	-17.63232287340307	-0.52780959016488	12.58029571389830
H	-18.26765766403501	-1.36330219192714	12.24457135345576
H	-19.24299758351104	0.62233982713054	14.25552276650465
H	-17.31191211569395	-0.73979871847493	13.61545755628891
C	-17.80526107155769	-1.41261841863971	8.09303155458852
O	-17.82465451720558	-0.40597747752957	7.32797607122514
O	-16.98155092358317	-1.11041853893125	9.15920774228545
H	-16.91768429459223	-1.88336696883828	9.74284838464786
Zn	-16.70467325583853	1.16631391211080	8.14105616603821

*

APPENDIX B

OUTPUT FILE FOR SAMPLES

Geometry optimizations were studied to find the geometry that minimizes the total energy for the given method. After a geometry optimization was run, a file named samplename.xyz can be printed with the final geometry coordinates that can be used in various calculation. These are the xyz files for samples used in computational studies.

CNT

C	-6.65697	-3.00970	-0.00376
C	-6.94172	-1.67425	-0.00371
C	-7.38856	-1.02465	1.20611
C	-8.45141	-0.06863	1.20612
C	-9.14442	0.30704	-0.00381
C	-10.50251	0.44958	-0.00389
C	-11.25847	0.22587	1.20600
C	-12.49619	-0.48942	1.20597
C	-13.06767	-1.03260	-0.00388
C	-13.62215	-2.28041	-0.00383
C	-13.64239	-3.06861	1.20604
C	-13.34430	-4.46670	1.20613
C	-13.00436	-5.17802	-0.00382
C	-11.98919	-6.09121	-0.00385

C	-11.24595	-6.35439	1.20603
C	-9.82421	-6.50352	1.20596
C	-9.04276	-6.39990	-0.00399
C	-7.86048	-5.71674	-0.00396
C	-7.38052	-5.09142	1.20605
C	-6.79999	-3.78507	1.20609
C	-6.74744	-3.06686	2.43751
C	-7.04759	-1.65891	2.43755
C	-7.41580	-1.04632	3.67454
C	-8.47021	-0.09765	3.67457
C	-9.11817	0.20373	2.43749
C	-10.54985	0.35403	2.43741
C	-11.24641	0.19379	3.67447
C	-12.47447	-0.51585	3.67443
C	-12.96101	-1.03939	2.43741
C	-13.54558	-2.35498	2.43747
C	-13.60770	-3.06691	3.67451
C	-13.31192	-4.45406	3.67456
C	-12.96468	-5.07869	2.43752
C	-11.89445	-6.04152	2.43748
C	-11.23665	-6.32109	3.67450
C	-9.82610	-6.46933	3.67446
C	-9.12472	-6.33221	2.43737

C	-7.87826	-5.61192	2.43743
C	-7.40938	-5.07256	3.67451
C	-6.83355	-3.77637	3.67452
C	-6.75670	-3.05646	4.91856
C	-7.05185	-1.67220	4.91857
C	-7.39988	-1.03824	6.15645
C	-8.46395	-0.08086	6.15646
C	-9.13101	0.19835	4.91855
C	-10.53866	0.34629	4.91851
C	-11.24923	0.21162	6.15642
C	-12.48857	-0.50454	6.15639
C	-12.95980	-1.05309	4.91849
C	-13.53439	-2.34661	4.91852
C	-13.62541	-3.06404	6.15641
C	-13.32694	-4.46393	6.15643
C	-12.95104	-5.08175	4.91855
C	-11.89884	-6.02845	4.91853
C	-11.24481	-6.33705	6.15643
C	-9.82130	-6.48670	6.15642
C	-9.11749	-6.32051	4.91850
C	-7.89198	-5.61229	4.91853
C	-7.39669	-5.08536	6.15645
C	-6.81563	-3.77724	6.15644

C	-6.74103	-3.06127	7.38654
C	-7.03951	-1.66139	7.38653
C	-7.41545	-1.04359	8.62443
C	-8.46762	-0.09686	8.62445
C	-9.12164	0.21177	7.38654
C	-10.54513	0.36141	7.38654
C	-11.24895	0.19520	8.62447
C	-12.47446	-0.51300	8.62443
C	-12.96973	-1.03996	7.38650
C	-13.55077	-2.34807	7.38650
C	-13.60973	-3.06885	8.62440
C	-13.31458	-4.45310	8.62441
C	-12.96657	-5.08708	7.38652
C	-11.90250	-6.04443	7.38652
C	-11.23542	-6.32362	8.62444
C	-9.82778	-6.47157	8.62446
C	-9.11720	-6.33691	7.38654
C	-7.87788	-5.62073	7.38657
C	-7.40661	-5.07221	8.62448
C	-6.83202	-3.77871	8.62444
C	-6.75870	-3.05841	9.86846
C	-7.05449	-1.67125	9.86842
C	-7.40180	-1.04664	11.10545

C	-8.47202	-0.08381	11.10548
C	-9.12980	0.19582	9.86847
C	-10.54037	0.34403	9.86850
C	-11.24176	0.20694	11.10556
C	-12.48822	-0.51335	11.10550
C	-12.95708	-1.05271	9.86844
C	-13.53292	-2.34893	9.86843
C	-13.61905	-3.05842	11.10543
C	-13.31886	-4.46635	11.10542
C	-12.95063	-5.07895	9.86845
C	-11.89622	-6.02765	9.86843
C	-11.24825	-6.32904	11.10549
C	-9.81658	-6.47938	11.10554
C	-9.12002	-6.31911	9.86850
C	-7.89196	-5.60943	9.86853
C	-7.40538	-5.08594	11.10554
C	-6.82082	-3.77036	11.10548
C	-6.72409	-3.05672	12.33692
C	-7.02222	-1.65868	12.33685
C	-7.36213	-0.94732	13.54681
C	-8.37732	-0.03417	13.54685
C	-9.12056	0.22902	12.33694
C	-10.54226	0.37820	12.33699

C	-11.32377	0.27469	13.54695
C	-12.50601	-0.40849	13.54692
C	-12.98594	-1.03387	12.33690
C	-13.56646	-2.34018	12.33685
C	-13.70955	-3.11554	13.54672
C	-13.42467	-4.45094	13.54672
C	-12.97779	-5.10055	12.33689
C	-11.91494	-6.05652	12.33690
C	-11.22194	-6.43225	13.54684
C	-9.86389	-6.57486	13.54689
C	-9.10795	-6.35111	12.33697
C	-7.87021	-5.63593	12.33697
C	-7.29866	-5.09278	13.54683
C	-6.74423	-3.84496	13.54679
H	-6.44718	-3.51345	-0.94910
H	-6.95559	-1.12876	-0.94908
H	-8.60075	0.35055	-0.94932
H	-11.02527	0.60477	-0.94945
H	-12.94142	-0.50167	-0.94921
H	-13.93173	-2.73000	-0.94908
H	-13.47042	-4.89366	-0.94903
H	-11.65709	-6.52432	-0.94916
H	-9.45732	-6.75493	-0.94929

H	-7.34601	-5.53467	-0.94928
H	-6.89604	-1.23169	14.49200
H	-8.70923	0.39923	14.49209
H	-10.90912	0.62963	14.49224
H	-13.02060	-0.59044	14.49220
H	-13.91912	-2.61170	14.49207
H	-13.41088	-4.99647	14.49207
H	-11.76566	-6.47579	14.49233
H	-9.34109	-6.73002	14.49244
H	-7.42498	-5.62371	14.49214
H	-6.43469	-3.39533	14.49203
Zn	-5.10043	-4.01094	6.15073

fCNT

C	-6.53761	-3.17130	0.02618
C	-6.85097	-1.83854	0.01096
C	-7.32173	-1.18950	1.20702
C	-8.38417	-0.24043	1.19602
C	-9.06224	0.13797	-0.02079
C	-10.40867	0.34337	-0.02767
C	-11.18855	0.19686	1.18686
C	-12.49442	-0.26777	1.17210
C	-13.12041	-0.78917	-0.03913

C	-13.63464	-2.04379	-0.01009
C	-13.53512	-2.84241	1.21887
C	-13.19438	-4.23993	1.19509
C	-12.84382	-4.92130	-0.01475
C	-11.88057	-5.90072	-0.01075
C	-11.19974	-6.24995	1.20122
C	-9.78325	-6.52497	1.22071
C	-8.98462	-6.47976	0.02845
C	-7.76208	-5.85898	0.03776
C	-7.27759	-5.24218	1.24141
C	-6.67895	-3.93624	1.23661
C	-6.65589	-3.20634	2.46139
C	-6.97424	-1.81140	2.44960
C	-7.33386	-1.18065	3.68071
C	-8.38727	-0.22035	3.67232
C	-9.05550	0.05511	2.42914
C	-10.45574	0.29714	2.43393
C	-11.16175	0.23904	3.67921
C	-12.47480	-0.28756	3.71309
C	-13.23859	-0.64429	2.44272
C	-13.49172	-2.16115	2.43413
C	-13.51111	-2.86842	3.66480
C	-13.19506	-4.25365	3.66112

C	-12.84086	-4.87146	2.42175
C	-11.83373	-5.89350	2.42561
C	-11.21927	-6.23244	3.67557
C	-9.81804	-6.47669	3.69274
C	-9.09393	-6.38206	2.45765
C	-7.81560	-5.72936	2.46966
C	-7.33996	-5.20085	3.71260
C	-6.74169	-3.90868	3.70924
C	-6.66504	-3.18380	4.93608
C	-6.95995	-1.78241	4.92246
C	-7.31304	-1.14248	6.14887
C	-8.35341	-0.16399	6.14047
C	-9.01450	0.12503	4.90242
C	-10.42715	0.35475	4.90724
C	-11.12277	0.27271	6.14867
C	-12.39753	-0.36353	6.15979
C	-12.94623	-0.83058	4.92573
C	-13.52662	-2.16215	4.91368
C	-13.58483	-2.88840	6.12614
C	-13.27746	-4.29410	6.12408
C	-12.89598	-4.90806	4.89838
C	-11.88071	-5.91786	4.90392
C	-11.25779	-6.25051	6.14325

C	-9.84570	-6.48062	6.15945
C	-9.11974	-6.37461	4.93490
C	-7.84633	-5.71754	4.94539
C	-7.36535	-5.18421	6.17826
C	-6.75749	-3.89004	6.17473
C	-6.67902	-3.16481	7.40556
C	-6.95543	-1.75859	7.39364
C	-7.30065	-1.11906	8.61811
C	-8.33615	-0.12681	8.61104
C	-8.98713	0.17655	7.37811
C	-10.40253	0.39595	7.38385
C	-11.10687	0.28205	8.61449
C	-12.37815	-0.38509	8.61929
C	-12.88894	-0.89384	7.39237
C	-13.50693	-2.18578	7.38133
C	-13.59207	-2.90594	8.60123
C	-13.31934	-4.31950	8.59642
C	-12.95055	-4.93518	7.36309
C	-11.91902	-5.92872	7.37211
C	-11.29054	-6.25487	8.61083
C	-9.87218	-6.46994	8.62637
C	-9.14828	-6.35975	7.40364
C	-7.87970	-5.69472	7.41383

C	-7.39722	-5.16406	8.64433
C	-6.77816	-3.87024	8.64046
C	-6.71079	-3.14655	9.87054
C	-6.96954	-1.74986	9.85974
C	-7.30024	-1.10772	11.09926
C	-8.33732	-0.11212	11.09299
C	-8.98652	0.18430	9.84638
C	-10.39223	0.38671	9.84911
C	-11.09738	0.27102	11.09408
C	-12.36520	-0.40690	11.09578
C	-12.85887	-0.92297	9.85037
C	-13.47788	-2.20104	9.84187
C	-13.58386	-2.91297	11.08240
C	-13.33127	-4.32794	11.07675
C	-12.97326	-4.94752	9.82905
C	-11.94451	-5.93135	9.83773
C	-11.31754	-6.25479	11.08849
C	-9.89415	-6.45136	11.10397
C	-9.17814	-6.32653	9.86721
C	-7.92186	-5.66229	9.87689
C	-7.43396	-5.14330	11.12203
C	-6.80645	-3.84995	11.11884
C	-6.67358	-3.13911	12.34150

C	-6.92367	-1.71095	12.33058
C	-7.24477	-0.99088	13.52486
C	-8.23607	-0.03809	13.51873
C	-8.96179	0.24609	12.31798
C	-10.39909	0.43957	12.32004
C	-11.17244	0.34266	13.52049
C	-12.38417	-0.30836	13.52070
C	-12.89163	-0.89788	12.31925
C	-13.53052	-2.20108	12.31200
C	-13.69475	-2.96961	13.50671
C	-13.46097	-4.32530	13.50123
C	-13.04367	-4.98490	12.30188
C	-11.99494	-5.98956	12.30925
C	-11.32576	-6.37104	13.51350
C	-9.96122	-6.55259	13.52832
C	-9.19226	-6.36528	12.33776
C	-7.91275	-5.68151	12.34728
C	-7.34920	-5.14569	13.54841
C	-6.74471	-3.91013	13.54565
H	-6.32145	-3.67909	-0.91568
H	-6.87635	-1.30729	-0.94209
H	-8.51324	0.14922	-0.96420
H	-10.92327	0.51810	-0.97402

H	-13.07881	-0.23114	-0.97844
H	-14.04871	-2.49470	-0.91412
H	-13.24113	-4.57153	-0.96897
H	-11.53146	-6.30262	-0.96332
H	-9.40799	-6.80576	-0.92343
H	-7.23721	-5.70029	-0.90606
H	-6.81440	-1.29947	14.47931
H	-8.56742	0.38590	14.46835
H	-10.73735	0.64659	14.47423
H	-12.87838	-0.50336	14.47416
H	-13.85565	-2.46540	14.46136
H	-13.44270	-4.86124	14.45184
H	-11.86628	-6.36582	14.46171
H	-9.45730	-6.68617	14.48728
H	-7.53088	-5.64176	14.50359
H	-6.46223	-3.45903	14.49852
C	-14.58262	0.12251	2.52166
O	-15.62237	-0.40641	2.86631
O	-14.45031	1.40346	2.22407
H	-15.32889	1.86291	2.27785

ffcNT

C	-6.53639	-3.13338	0.02282
C	-6.87978	-1.80832	0.01414
C	-7.36515	-1.17202	1.21211
C	-8.44002	-0.24034	1.20203
C	-9.11513	0.14226	-0.01557
C	-10.46357	0.33046	-0.02715
C	-11.25279	0.16883	1.18121
C	-12.55391	-0.30571	1.15386
C	-13.15577	-0.84845	-0.05474
C	-13.69303	-2.09595	-0.01466
C	-13.59608	-2.87727	1.22271
C	-13.19961	-4.26879	1.20654
C	-12.83569	-4.93921	-0.00043
C	-11.84828	-5.89903	-0.00364
C	-11.16062	-6.24161	1.20121
C	-9.74093	-6.50896	1.21509
C	-8.94746	-6.45972	0.01996
C	-7.72806	-5.83254	0.02772
C	-7.23956	-5.22151	1.23234
C	-6.66458	-3.90545	1.23083
C	-6.65547	-3.17794	2.45753
C	-7.00226	-1.79117	2.45078

C	-7.39246	-1.17997	3.68202
C	-8.46751	-0.24625	3.67561
C	-9.12997	0.03510	2.43142
C	-10.52497	0.28435	2.42907
C	-11.24324	0.20828	3.66658
C	-12.56281	-0.29339	3.68887
C	-13.31814	-0.67034	2.41969
C	-13.55310	-2.18808	2.42923
C	-13.53143	-2.88357	3.67540
C	-13.16515	-4.26264	3.67232
C	-12.81239	-4.88007	2.43215
C	-11.78804	-5.88441	2.43006
C	-11.16400	-6.22515	3.67318
C	-9.76316	-6.47627	3.68592
C	-9.04440	-6.37552	2.44885
C	-7.76676	-5.72206	2.45927
C	-7.29301	-5.19219	3.70188
C	-6.72026	-3.88931	3.70140
C	-6.65894	-3.16832	4.93173
C	-7.00871	-1.77943	4.92197
C	-7.38489	-1.15601	6.15020
C	-8.45580	-0.21382	6.14297
C	-9.11325	0.06801	4.90749

C	-10.52764	0.28489	4.90812
C	-11.24551	0.22082	6.14940
C	-12.55965	-0.29289	6.13530
C	-13.06408	-0.78911	4.91039
C	-13.57292	-2.16920	4.90634
C	-13.54760	-2.88456	6.13682
C	-13.19085	-4.27370	6.12971
C	-12.83091	-4.89791	4.90186
C	-11.81331	-5.90399	4.90476
C	-11.18954	-6.24848	6.14146
C	-9.78083	-6.49094	6.15404
C	-9.05966	-6.38495	4.92574
C	-7.79279	-5.71640	4.93549
C	-7.30907	-5.18673	6.17071
C	-6.72796	-3.88026	6.16760
C	-6.67553	-3.15167	7.39835
C	-6.99768	-1.76136	7.38778
C	-7.37853	-1.13635	8.61361
C	-8.44151	-0.19106	8.60925
C	-9.11954	0.09521	7.37742
C	-10.51517	0.33657	7.38254
C	-11.22777	0.20038	8.62612
C	-12.51783	-0.33549	8.65745

C	-13.31187	-0.67578	7.40761
C	-13.55814	-2.19137	7.38384
C	-13.57638	-2.89857	8.58721
C	-13.23015	-4.29482	8.58915
C	-12.86143	-4.91259	7.36207
C	-11.84343	-5.92092	7.36963
C	-11.21949	-6.24818	8.60564
C	-9.80657	-6.47230	8.62122
C	-9.08001	-6.37402	7.39643
C	-7.81360	-5.70746	7.40555
C	-7.33877	-5.16763	8.63810
C	-6.75532	-3.86282	8.63433
C	-6.70099	-3.13550	9.86650
C	-7.01140	-1.75051	9.85621
C	-7.35343	-1.11499	11.09349
C	-8.41375	-0.14432	11.09040
C	-9.08418	0.12236	9.85049
C	-10.48691	0.31347	9.86184
C	-11.17401	0.23052	11.11308
C	-12.44985	-0.42681	11.12660
C	-12.97455	-0.90301	9.88380
C	-13.55888	-2.19991	9.86208
C	-13.63101	-2.93100	11.08045

C	-13.30746	-4.34039	11.07000
C	-12.89944	-4.93029	9.82413
C	-11.87346	-5.91220	9.83304
C	-11.25581	-6.24452	11.08209
C	-9.83367	-6.45271	11.10022
C	-9.11333	-6.33500	9.86574
C	-7.85942	-5.66937	9.87426
C	-7.37697	-5.14363	11.11798
C	-6.77185	-3.83953	11.11347
C	-6.66260	-3.12192	12.33533
C	-6.95304	-1.70712	12.32421
C	-7.27874	-0.98862	13.52236
C	-8.28898	-0.06085	13.51985
C	-9.03411	0.20503	12.32168
C	-10.46231	0.39317	12.33629
C	-11.22736	0.29608	13.54810
C	-12.43189	-0.35988	13.55726
C	-12.95074	-0.94501	12.35157
C	-13.57793	-2.23993	12.32947
C	-13.73137	-3.02899	13.52012
C	-13.46662	-4.37244	13.50176
C	-13.01119	-4.99846	12.28794
C	-11.93805	-5.97122	12.29842

C	-11.27138	-6.34756	13.50903
C	-9.90939	-6.53218	13.52744
C	-9.13534	-6.36136	12.33495
C	-7.85931	-5.67871	12.34388
C	-7.29804	-5.13802	13.54743
C	-6.71644	-3.89429	13.54276
H	-6.30921	-3.63269	-0.92094
H	-6.91419	-1.27385	-0.93691
H	-8.56124	0.17244	-0.95588
H	-10.97309	0.50890	-0.97591
H	-13.08404	-0.31472	-1.00668
H	-14.09387	-2.55825	-0.91836
H	-13.24061	-4.59529	-0.95313
H	-11.49329	-6.28590	-0.96019
H	-9.37492	-6.77966	-0.93194
H	-7.21009	-5.66422	-0.91829
H	-6.82489	-1.27834	14.47179
H	-8.61524	0.37016	14.46805
H	-10.78721	0.60981	14.49630
H	-12.92337	-0.55581	14.51213
H	-13.92879	-2.53701	14.47476
H	-13.46585	-4.93180	14.43864
H	-11.81556	-6.33977	14.45462

H	-9.40730	-6.66303	14.48770
H	-7.46799	-5.64029	14.50137
H	-6.43581	-3.43807	14.49376
C	-14.62503	0.14573	7.41870
O	-14.74552	1.22798	7.92447
O	-15.61360	-0.47427	6.74614
H	-16.37106	0.12706	6.71748
C	-14.67583	0.07282	2.46224
O	-15.73074	-0.41854	2.75700
O	-14.52869	1.38174	2.16958
H	-15.40027	1.79219	2.25986

fffCNT

C	-6.38308	-3.42742	0.01572
C	-6.73216	-2.10038	-0.01282
C	-7.23114	-1.45561	1.16926
C	-8.29361	-0.48910	1.13690
C	-8.88533	-0.04964	-0.09439
C	-10.20713	0.28470	-0.14738
C	-11.03769	0.20962	1.03087
C	-12.39360	-0.09691	0.94895
C	-12.98811	-0.65759	-0.26146
C	-13.51319	-1.90500	-0.16811
C	-13.39781	-2.64521	1.09748

C	-12.99034	-4.03495	1.10621
C	-12.65519	-4.74734	-0.08023
C	-11.73355	-5.77461	-0.05819
C	-11.08853	-6.15613	1.15469
C	-9.70343	-6.58340	1.19281
C	-8.89239	-6.61802	0.01223
C	-7.62386	-6.09240	0.03268
C	-7.11777	-5.49782	1.23654
C	-6.51242	-4.18658	1.22722
C	-6.52492	-3.44964	2.44411
C	-6.90652	-2.06851	2.41201
C	-7.33399	-1.45590	3.63403
C	-8.41360	-0.54337	3.60080
C	-9.01036	-0.20734	2.34420
C	-10.38666	0.15982	2.30863
C	-11.17989	0.17083	3.52944
C	-12.55741	0.05890	3.48498
C	-13.22414	-0.37458	2.18526
C	-13.37234	-1.91642	2.27809
C	-13.26605	-2.56193	3.55624
C	-12.92312	-3.95316	3.57125
C	-12.61347	-4.62148	2.34636
C	-11.68182	-5.71101	2.36962
C	-11.11274	-6.10228	3.62579

C	-9.75320	-6.51755	3.66470
C	-9.01412	-6.50334	2.43473
C	-7.68769	-5.95290	2.45909
C	-7.20595	-5.43303	3.70901
C	-6.61089	-4.14433	3.69786
C	-6.56959	-3.40430	4.92127
C	-6.94010	-2.02693	4.88458
C	-7.33951	-1.38729	6.08956
C	-8.42529	-0.45814	6.05248
C	-9.08839	-0.20650	4.81792
C	-10.47202	0.12219	4.80525
C	-11.18458	0.20268	6.02718
C	-12.65406	0.25693	6.04165
C	-13.32384	-0.31665	4.75197
C	-13.33835	-1.85155	4.77850
C	-13.30779	-2.53934	6.01135
C	-12.98577	-3.93907	6.02316
C	-12.64322	-4.58891	4.80840
C	-11.74367	-5.70421	4.83809
C	-11.18668	-6.10067	6.08610
C	-9.81535	-6.50043	6.13090
C	-9.06369	-6.48085	4.91653
C	-7.74382	-5.92211	4.94336
C	-7.26461	-5.39098	6.18062

C	-6.65507	-4.09573	6.16785
C	-6.62391	-3.34393	7.38603
C	-6.96625	-1.95746	7.34206
C	-7.35874	-1.29938	8.54787
C	-8.39961	-0.33267	8.50861
C	-9.06360	-0.07924	7.26468
C	-10.44673	0.25823	7.24125
C	-11.14550	0.32417	8.50652
C	-12.48727	-0.03448	8.56292
C	-13.31514	-0.33666	7.31947
C	-13.44086	-1.86517	7.26537
C	-13.48779	-2.58487	8.46049
C	-13.15308	-3.98428	8.47615
C	-12.75351	-4.60393	7.26187
C	-11.83329	-5.70082	7.29690
C	-11.28007	-6.08281	8.54777
C	-9.89617	-6.44972	8.59845
C	-9.13576	-6.42909	7.39004
C	-7.82434	-5.85651	7.41673
C	-7.35545	-5.31145	8.65181
C	-6.73309	-4.02460	8.63633
C	-6.70283	-3.26830	9.85224
C	-7.00166	-1.88058	9.80770
C	-7.33966	-1.20520	11.02262

C	-8.35708	-0.18859	10.98565
C	-9.01428	0.07591	9.73796
C	-10.39096	0.40602	9.74016
C	-11.08055	0.42031	10.99566
C	-12.39985	-0.14980	11.02617
C	-12.95739	-0.59896	9.79361
C	-13.52171	-1.89900	9.74798
C	-13.61835	-2.63123	10.96190
C	-13.32582	-4.04670	10.95520
C	-12.90076	-4.64305	9.71681
C	-11.94022	-5.69050	9.75502
C	-11.38346	-6.06765	11.02060
C	-9.98174	-6.38364	11.07416
C	-9.22501	-6.34291	9.85585
C	-7.92896	-5.76226	9.88440
C	-7.45709	-5.22911	11.12958
C	-6.81603	-3.94187	11.11258
C	-6.71903	-3.19822	12.32107
C	-6.96588	-1.77696	12.27194
C	-7.26545	-1.01161	13.44731
C	-8.22009	-0.02814	13.41466
C	-8.94993	0.24267	12.20705
C	-10.35748	0.53908	12.21639
C	-11.12588	0.49343	13.43424

C	-12.35925	-0.10243	13.45540
C	-12.91033	-0.66336	12.24910
C	-13.57248	-1.93734	12.21342
C	-13.77335	-2.72252	13.40025
C	-13.55215	-4.07300	13.38196
C	-13.08937	-4.71647	12.17922
C	-12.07683	-5.75061	12.21987
C	-11.46392	-6.16145	13.44714
C	-10.11757	-6.43422	13.49955
C	-9.30714	-6.32161	12.32419
C	-7.99304	-5.71501	12.35365
C	-7.44405	-5.16556	13.55945
C	-6.81992	-3.94267	13.54407
H	-6.15756	-3.93661	-0.92322
H	-6.76409	-1.58257	-0.97285
H	-8.30310	-0.07992	-1.01688
H	-10.67110	0.51339	-1.10822
H	-12.92182	-0.14596	-1.22540
H	-13.92173	-2.40216	-1.05004
H	-13.02859	-4.40002	-1.04462
H	-11.39864	-6.19841	-1.00639
H	-9.33125	-6.90748	-0.94459
H	-7.08280	-5.97002	-0.90756
H	-6.82709	-1.29497	14.40611

H	-8.51933	0.45289	14.34735
H	-10.66530	0.79053	14.37796
H	-12.85434	-0.27304	14.41334
H	-13.97568	-2.22544	14.35129
H	-13.59393	-4.63403	14.31695
H	-12.02828	-6.11521	14.37987
H	-9.64665	-6.58981	14.47194
H	-7.65652	-5.63942	14.51965
H	-6.54834	-3.47438	14.49182
C	-14.66993	0.35948	7.59707
O	-14.83834	1.55883	7.35007
O	-15.57761	-0.38934	8.15495
H	-16.45339	0.08019	8.20769
C	-14.60020	0.29086	1.93491
O	-15.66952	-0.22769	2.12415
O	-14.46380	1.53589	1.44973
H	-15.36165	1.88531	1.31769
H	-15.75793	1.80023	4.52503
O	-14.83279	1.51855	4.41111
C	-14.76501	0.21379	4.77648
O	-15.72238	-0.38596	5.18785

CNTPVA01

C	-6.63721	-3.01158	-0.00047
C	-6.92670	-1.67743	-0.00262
C	-7.38541	-1.03105	1.20495
C	-8.45542	-0.08384	1.20255
C	-9.15124	0.27996	-0.00866
C	-10.50820	0.42927	-0.00667
C	-11.26288	0.21844	1.20581
C	-12.50424	-0.48976	1.20880
C	-13.08547	-1.02732	0.00057
C	-13.63666	-2.27590	0.00024
C	-13.65004	-3.06583	1.20905
C	-13.34632	-4.46218	1.20686
C	-13.00102	-5.16575	-0.00554
C	-11.98362	-6.07625	-0.00654
C	-11.24414	-6.34293	1.20455
C	-9.82295	-6.49451	1.20549
C	-9.04157	-6.38966	-0.00422
C	-7.85776	-5.70998	-0.00277
C	-7.37633	-5.08862	1.20839
C	-6.78913	-3.78611	1.20914
C	-6.73832	-3.06752	2.43972
C	-7.04216	-1.66048	2.43801
C	-7.41321	-1.04760	3.67372

C	-8.47075	-0.10266	3.67241
C	-9.12057	0.19250	2.43455
C	-10.55168	0.34664	2.43597
C	-11.24717	0.19006	3.67432
C	-12.47583	-0.51811	3.67616
C	-12.96687	-1.03967	2.44059
C	-13.55252	-2.35398	2.44066
C	-13.61365	-3.06723	3.67638
C	-13.31622	-4.45408	3.67526
C	-12.96689	-5.07591	2.43748
C	-11.89425	-6.03535	2.43660
C	-11.23697	-6.31568	3.67398
C	-9.82646	-6.46501	3.67429
C	-9.12430	-6.32647	2.43766
C	-7.87722	-5.60829	2.43873
C	-7.40774	-5.07052	3.67586
C	-6.82873	-3.77626	3.67619
C	-6.75206	-3.05564	4.91918
C	-7.04803	-1.67155	4.91835
C	-7.39658	-1.03761	6.15594
C	-8.46285	-0.08277	6.15551
C	-9.13082	0.19360	4.91709
C	-10.53840	0.34276	4.91783
C	-11.24853	0.20863	6.15624

C	-12.48760	-0.50774	6.15694
C	-12.96096	-1.05546	4.91993
C	-13.53790	-2.34748	4.92003
C	-13.62982	-3.06518	6.15711
C	-13.33107	-4.46512	6.15694
C	-12.95442	-5.08202	4.91889
C	-11.90000	-6.02610	4.91856
C	-11.24569	-6.33352	6.15685
C	-9.82214	-6.48396	6.15666
C	-9.11816	-6.31744	4.91873
C	-7.89279	-5.60934	4.91905
C	-7.39663	-5.08270	6.15641
C	-6.81319	-3.77613	6.15649
C	-6.73669	-3.06008	7.38586
C	-7.03541	-1.66023	7.38603
C	-7.41214	-1.04334	8.62414
C	-8.46648	-0.09924	8.62445
C	-9.12080	0.20822	7.38608
C	-10.54425	0.35864	7.38625
C	-11.24825	0.19207	8.62426
C	-12.47359	-0.51600	8.62395
C	-12.96982	-1.04265	7.38653
C	-13.55319	-2.34914	7.38648
C	-13.61426	-3.06967	8.62386

C	-13.31833	-4.45372	8.62469
C	-12.96983	-5.08772	7.38703
C	-11.90361	-6.04248	7.38743
C	-11.23558	-6.31882	8.62591
C	-9.82805	-6.46802	8.62516
C	-9.11786	-6.33391	7.38668
C	-7.87892	-5.61757	7.38599
C	-7.40557	-5.06980	8.62308
C	-6.82866	-3.77781	8.62300
C	-6.75276	-3.05813	9.86664
C	-7.05022	-1.67117	9.86777
C	-7.39966	-1.04942	11.10550
C	-8.47218	-0.08988	11.10633
C	-9.12941	0.19049	9.86900
C	-10.54002	0.33985	9.86868
C	-11.24213	0.20121	11.10526
C	-12.48918	-0.51695	11.10418
C	-12.95869	-1.05471	9.86713
C	-13.53773	-2.34906	9.86685
C	-13.62801	-3.05777	11.10328
C	-13.32424	-4.46481	11.10497
C	-12.95331	-5.07772	9.86931
C	-11.89569	-6.02273	9.87059
C	-11.24585	-6.31781	11.10840

C	-9.81477	-6.47201	11.10696
C	-9.11928	-6.31547	9.86866
C	-7.89054	-5.60725	9.86683
C	-7.39958	-5.08568	11.10237
C	-6.81399	-3.77137	11.10231
C	-6.71635	-3.05945	12.33393
C	-7.02027	-1.66326	12.33616
C	-7.36572	-0.95957	13.54857
C	-8.38266	-0.04866	13.54950
C	-9.12228	0.21802	12.33838
C	-10.54338	0.36922	12.33745
C	-11.32491	0.26438	13.54717
C	-12.50885	-0.41495	13.54570
C	-12.99033	-1.03649	12.33454
C	-13.57703	-2.33909	12.33390
C	-13.72890	-3.11373	13.54356
C	-13.43977	-4.44787	13.54568
C	-12.98106	-5.09441	12.33806
C	-11.91108	-6.04146	12.34044
C	-11.21508	-6.40523	13.55168
C	-9.85825	-6.55490	13.54965
C	-9.10347	-6.34388	12.33714
C	-7.86224	-5.63571	12.33419
C	-7.28103	-5.09796	13.54246

C	-6.72971	-3.84951	13.54277
H	-6.40954	-3.51455	-0.94194
H	-6.92942	-1.12961	-0.94669
H	-8.61181	0.30880	-0.95675
H	-11.03126	0.58241	-0.95201
H	-12.97133	-0.48921	-0.94217
H	-13.95723	-2.72360	-0.94203
H	-13.46459	-4.87385	-0.94957
H	-11.64663	-6.50751	-0.95085
H	-9.45853	-6.74345	-0.94874
H	-7.34007	-5.52853	-0.94634
H	-6.90046	-1.24987	14.49226
H	-8.72038	0.38182	14.49392
H	-10.90862	0.61973	14.49141
H	-13.02642	-0.59670	14.48928
H	-13.95803	-2.61091	14.48474
H	-13.43694	-4.99575	14.48972
H	-11.75484	-6.43571	14.49952
H	-9.33506	-6.70757	14.49499
H	-7.39408	-5.63671	14.48496
H	-6.40907	-3.40175	14.48499
C	-5.85527	0.90681	7.49512
C	-5.68124	1.12916	6.18960
O	-6.43391	2.03191	5.52255

H	-4.92007	0.57497	5.65002
H	-7.12581	2.55255	5.95583
H	-5.23846	0.17666	8.00907

CNTPVA02

C	-6.63721	-3.01158	-0.00047
C	-6.92670	-1.67743	-0.00262
C	-7.38541	-1.03105	1.20495
C	-8.45542	-0.08384	1.20255
C	-9.15124	0.27996	-0.00866
C	-10.50820	0.42927	-0.00667
C	-11.26288	0.21844	1.20581
C	-12.50424	-0.48976	1.20880
C	-13.08547	-1.02732	0.00057
C	-13.63666	-2.27590	0.00024
C	-13.65004	-3.06583	1.20905
C	-13.34632	-4.46218	1.20686
C	-13.00102	-5.16575	-0.00554
C	-11.98362	-6.07625	-0.00654
C	-11.24414	-6.34293	1.20455
C	-9.82295	-6.49451	1.20549
C	-9.04157	-6.38966	-0.00422
C	-7.85776	-5.70998	-0.00277
C	-7.37633	-5.08862	1.20839

C	-6.78913	-3.78611	1.20914
C	-6.73832	-3.06752	2.43972
C	-7.04216	-1.66048	2.43801
C	-7.41321	-1.04760	3.67372
C	-8.47075	-0.10266	3.67241
C	-9.12057	0.19250	2.43455
C	-10.55168	0.34664	2.43597
C	-11.24717	0.19006	3.67432
C	-12.47583	-0.51811	3.67616
C	-12.96687	-1.03967	2.44059
C	-13.55252	-2.35398	2.44066
C	-13.61365	-3.06723	3.67638
C	-13.31622	-4.45408	3.67526
C	-12.96689	-5.07591	2.43748
C	-11.89425	-6.03535	2.43660
C	-11.23697	-6.31568	3.67398
C	-9.82646	-6.46501	3.67429
C	-9.12430	-6.32647	2.43766
C	-7.87722	-5.60829	2.43873
C	-7.40774	-5.07052	3.67586
C	-6.82873	-3.77626	3.67619
C	-6.75206	-3.05564	4.91918
C	-7.04803	-1.67155	4.91835
C	-7.39658	-1.03761	6.15594

C	-8.46285	-0.08277	6.15551
C	-9.13082	0.19360	4.91709
C	-10.53840	0.34276	4.91783
C	-11.24853	0.20863	6.15624
C	-12.48760	-0.50774	6.15694
C	-12.96096	-1.05546	4.91993
C	-13.53790	-2.34748	4.92003
C	-13.62982	-3.06518	6.15711
C	-13.33107	-4.46512	6.15694
C	-12.95442	-5.08202	4.91889
C	-11.90000	-6.02610	4.91856
C	-11.24569	-6.33352	6.15685
C	-9.82214	-6.48396	6.15666
C	-9.11816	-6.31744	4.91873
C	-7.89279	-5.60934	4.91905
C	-7.39663	-5.08270	6.15641
C	-6.81319	-3.77613	6.15649
C	-6.73669	-3.06008	7.38586
C	-7.03541	-1.66023	7.38603
C	-7.41214	-1.04334	8.62414
C	-8.46648	-0.09924	8.62445
C	-9.12080	0.20822	7.38608
C	-10.54425	0.35864	7.38625
C	-11.24825	0.19207	8.62426

C	-12.47359	-0.51600	8.62395
C	-12.96982	-1.04265	7.38653
C	-13.55319	-2.34914	7.38648
C	-13.61426	-3.06967	8.62386
C	-13.31833	-4.45372	8.62469
C	-12.96983	-5.08772	7.38703
C	-11.90361	-6.04248	7.38743
C	-11.23558	-6.31882	8.62591
C	-9.82805	-6.46802	8.62516
C	-9.11786	-6.33391	7.38668
C	-7.87892	-5.61757	7.38599
C	-7.40557	-5.06980	8.62308
C	-6.82866	-3.77781	8.62300
C	-6.75276	-3.05813	9.86664
C	-7.05022	-1.67117	9.86777
C	-7.39966	-1.04942	11.10550
C	-8.47218	-0.08988	11.10633
C	-9.12941	0.19049	9.86900
C	-10.54002	0.33985	9.86868
C	-11.24213	0.20121	11.10526
C	-12.48918	-0.51695	11.10418
C	-12.95869	-1.05471	9.86713
C	-13.53773	-2.34906	9.86685
C	-13.62801	-3.05777	11.10328

C	-13.32424	-4.46481	11.10497
C	-12.95331	-5.07772	9.86931
C	-11.89569	-6.02273	9.87059
C	-11.24585	-6.31781	11.10840
C	-9.81477	-6.47201	11.10696
C	-9.11928	-6.31547	9.86866
C	-7.89054	-5.60725	9.86683
C	-7.39958	-5.08568	11.10237
C	-6.81399	-3.77137	11.10231
C	-6.71635	-3.05945	12.33393
C	-7.02027	-1.66326	12.33616
C	-7.36572	-0.95957	13.54857
C	-8.38266	-0.04866	13.54950
C	-9.12228	0.21802	12.33838
C	-10.54338	0.36922	12.33745
C	-11.32491	0.26438	13.54717
C	-12.50885	-0.41495	13.54570
C	-12.99033	-1.03649	12.33454
C	-13.57703	-2.33909	12.33390
C	-13.72890	-3.11373	13.54356
C	-13.43977	-4.44787	13.54568
C	-12.98106	-5.09441	12.33806
C	-11.91108	-6.04146	12.34044
C	-11.21508	-6.40523	13.55168

C	-9.85825	-6.55490	13.54965
C	-9.10347	-6.34388	12.33714
C	-7.86224	-5.63571	12.33419
C	-7.28103	-5.09796	13.54246
C	-6.72971	-3.84951	13.54277
H	-6.40954	-3.51455	-0.94194
H	-6.92942	-1.12961	-0.94669
H	-8.61181	0.30880	-0.95675
H	-11.03126	0.58241	-0.95201
H	-12.97133	-0.48921	-0.94217
H	-13.95723	-2.72360	-0.94203
H	-13.46459	-4.87385	-0.94957
H	-11.64663	-6.50751	-0.95085
H	-9.45853	-6.74345	-0.94874
H	-7.34007	-5.52853	-0.94634
H	-6.90046	-1.24987	14.49226
H	-8.72038	0.38182	14.49392
H	-10.90862	0.61973	14.49141
H	-13.02642	-0.59670	14.48928
H	-13.95803	-2.61091	14.48474
H	-13.43694	-4.99575	14.48972
H	-11.75484	-6.43571	14.49952
H	-9.33506	-6.70757	14.49499
H	-7.39408	-5.63671	14.48496

H	-6.40907	-3.40175	14.48499
H	-1.52394	-0.88952	1.70367
H	0.84966	-0.37012	1.33597
H	0.03486	-2.60412	0.57387
C	-1.24074	-0.13862	0.93357
H	-1.23914	0.86308	1.41727
O	-3.54334	0.18808	0.37837
C	0.18936	-0.43202	0.43887
C	0.33666	-1.83262	-0.16613
C	-2.29844	-0.13322	-0.17633
H	1.39766	-2.00892	-0.44303
H	-4.18784	0.19718	-0.37633
H	-0.27744	-1.94362	-1.08303
O	0.57386	0.53978	-0.49913
H	1.56636	0.57018	-0.49393
H	-1.71610	0.16360	-1.02348

CNTPVA03

C	-6.63721	-3.01158	-0.00047
C	-6.92670	-1.67743	-0.00262
C	-7.38541	-1.03105	1.20495
C	-8.45542	-0.08384	1.20255
C	-9.15124	0.27996	-0.00866
C	-10.50820	0.42927	-0.00667

C	-11.26288	0.21844	1.20581
C	-12.50424	-0.48976	1.20880
C	-13.08547	-1.02732	0.00057
C	-13.63666	-2.27590	0.00024
C	-13.65004	-3.06583	1.20905
C	-13.34632	-4.46218	1.20686
C	-13.00102	-5.16575	-0.00554
C	-11.98362	-6.07625	-0.00654
C	-11.24414	-6.34293	1.20455
C	-9.82295	-6.49451	1.20549
C	-9.04157	-6.38966	-0.00422
C	-7.85776	-5.70998	-0.00277
C	-7.37633	-5.08862	1.20839
C	-6.78913	-3.78611	1.20914
C	-6.73832	-3.06752	2.43972
C	-7.04216	-1.66048	2.43801
C	-7.41321	-1.04760	3.67372
C	-8.47075	-0.10266	3.67241
C	-9.12057	0.19250	2.43455
C	-10.55168	0.34664	2.43597
C	-11.24717	0.19006	3.67432
C	-12.47583	-0.51811	3.67616
C	-12.96687	-1.03967	2.44059
C	-13.55252	-2.35398	2.44066

C	-13.61365	-3.06723	3.67638
C	-13.31622	-4.45408	3.67526
C	-12.96689	-5.07591	2.43748
C	-11.89425	-6.03535	2.43660
C	-11.23697	-6.31568	3.67398
C	-9.82646	-6.46501	3.67429
C	-9.12430	-6.32647	2.43766
C	-7.87722	-5.60829	2.43873
C	-7.40774	-5.07052	3.67586
C	-6.82873	-3.77626	3.67619
C	-6.75206	-3.05564	4.91918
C	-7.04803	-1.67155	4.91835
C	-7.39658	-1.03761	6.15594
C	-8.46285	-0.08277	6.15551
C	-9.13082	0.19360	4.91709
C	-10.53840	0.34276	4.91783
C	-11.24853	0.20863	6.15624
C	-12.48760	-0.50774	6.15694
C	-12.96096	-1.05546	4.91993
C	-13.53790	-2.34748	4.92003
C	-13.62982	-3.06518	6.15711
C	-13.33107	-4.46512	6.15694
C	-12.95442	-5.08202	4.91889
C	-11.90000	-6.02610	4.91856

C	-11.24569	-6.33352	6.15685
C	-9.82214	-6.48396	6.15666
C	-9.11816	-6.31744	4.91873
C	-7.89279	-5.60934	4.91905
C	-7.39663	-5.08270	6.15641
C	-6.81319	-3.77613	6.15649
C	-6.73669	-3.06008	7.38586
C	-7.03541	-1.66023	7.38603
C	-7.41214	-1.04334	8.62414
C	-8.46648	-0.09924	8.62445
C	-9.12080	0.20822	7.38608
C	-10.54425	0.35864	7.38625
C	-11.24825	0.19207	8.62426
C	-12.47359	-0.51600	8.62395
C	-12.96982	-1.04265	7.38653
C	-13.55319	-2.34914	7.38648
C	-13.61426	-3.06967	8.62386
C	-13.31833	-4.45372	8.62469
C	-12.96983	-5.08772	7.38703
C	-11.90361	-6.04248	7.38743
C	-11.23558	-6.31882	8.62591
C	-9.82805	-6.46802	8.62516
C	-9.11786	-6.33391	7.38668
C	-7.87892	-5.61757	7.38599

C	-7.40557	-5.06980	8.62308
C	-6.82866	-3.77781	8.62300
C	-6.75276	-3.05813	9.86664
C	-7.05022	-1.67117	9.86777
C	-7.39966	-1.04942	11.10550
C	-8.47218	-0.08988	11.10633
C	-9.12941	0.19049	9.86900
C	-10.54002	0.33985	9.86868
C	-11.24213	0.20121	11.10526
C	-12.48918	-0.51695	11.10418
C	-12.95869	-1.05471	9.86713
C	-13.53773	-2.34906	9.86685
C	-13.62801	-3.05777	11.10328
C	-13.32424	-4.46481	11.10497
C	-12.95331	-5.07772	9.86931
C	-11.89569	-6.02273	9.87059
C	-11.24585	-6.31781	11.10840
C	-9.81477	-6.47201	11.10696
C	-9.11928	-6.31547	9.86866
C	-7.89054	-5.60725	9.86683
C	-7.39958	-5.08568	11.10237
C	-6.81399	-3.77137	11.10231
C	-6.71635	-3.05945	12.33393
C	-7.02027	-1.66326	12.33616

C	-7.36572	-0.95957	13.54857
C	-8.38266	-0.04866	13.54950
C	-9.12228	0.21802	12.33838
C	-10.54338	0.36922	12.33745
C	-11.32491	0.26438	13.54717
C	-12.50885	-0.41495	13.54570
C	-12.99033	-1.03649	12.33454
C	-13.57703	-2.33909	12.33390
C	-13.72890	-3.11373	13.54356
C	-13.43977	-4.44787	13.54568
C	-12.98106	-5.09441	12.33806
C	-11.91108	-6.04146	12.34044
C	-11.21508	-6.40523	13.55168
C	-9.85825	-6.55490	13.54965
C	-9.10347	-6.34388	12.33714
C	-7.86224	-5.63571	12.33419
C	-7.28103	-5.09796	13.54246
C	-6.72971	-3.84951	13.54277
H	-6.40954	-3.51455	-0.94194
H	-6.92942	-1.12961	-0.94669
H	-8.61181	0.30880	-0.95675
H	-11.03126	0.58241	-0.95201
H	-12.97133	-0.48921	-0.94217
H	-13.95723	-2.72360	-0.94203

H	-13.46459	-4.87385	-0.94957
H	-11.64663	-6.50751	-0.95085
H	-9.45853	-6.74345	-0.94874
H	-7.34007	-5.52853	-0.94634
H	-6.90046	-1.24987	14.49226
H	-8.72038	0.38182	14.49392
H	-10.90862	0.61973	14.49141
H	-13.02642	-0.59670	14.48928
H	-13.95803	-2.61091	14.48474
H	-13.43694	-4.99575	14.48972
H	-11.75484	-6.43571	14.49952
H	-9.33506	-6.70757	14.49499
H	-7.39408	-5.63671	14.48496
H	-6.40907	-3.40175	14.48499
H	-17.22621	-7.94921	9.29875
H	-14.15451	-6.70801	7.51945
O	-15.09151	-6.38791	7.45405
O	-17.75591	-7.16521	9.59935
H	-20.83041	-8.45041	8.97275
C	-15.35821	-5.71991	8.65615
H	-17.68961	-6.82131	7.54495
O	-20.39871	-7.62131	9.30765
C	-17.85071	-6.28171	8.50955
H	-20.14671	-7.25101	7.28265

C	-20.36941	-6.71501	8.23555
C	-16.78921	-5.17321	8.64765
C	-19.26301	-5.66661	8.46135
H	-16.96161	-4.61471	9.59385
H	-16.88661	-4.46011	7.79955
C	-21.73471	-6.03431	8.11255
H	-19.46111	-5.11131	9.40525
H	-19.29641	-4.94191	7.61725
H	-21.83861	-5.52271	7.17855
H	-21.92411	-5.27781	8.84525
H	-15.17697	-6.38790	9.47215

fCNTPVA01

C	-6.56756	-3.12023	0.01747
C	-6.88695	-1.79097	0.01903
C	-7.36128	-1.15516	1.22468
C	-8.41268	-0.20516	1.22654
C	-9.08695	0.21041	0.01630
C	-10.42856	0.43428	0.01371
C	-11.22003	0.27026	1.22421
C	-12.52826	-0.18218	1.20118
C	-13.10982	-0.72078	-0.02428
C	-13.64448	-1.96528	-0.00023
C	-13.58692	-2.75027	1.24079

C	-13.23081	-4.14951	1.21594
C	-12.88496	-4.82271	0.00287
C	-11.92109	-5.80355	-0.00894
C	-11.23310	-6.16072	1.19375
C	-9.82182	-6.45412	1.20112
C	-9.02990	-6.41137	0.00212
C	-7.80226	-5.80381	0.00873
C	-7.30238	-5.20248	1.21643
C	-6.70654	-3.90092	1.22178
C	-6.67757	-3.18182	2.45498
C	-7.00035	-1.78994	2.46026
C	-7.36704	-1.18037	3.69741
C	-8.42749	-0.22716	3.70391
C	-9.08930	0.07707	2.46379
C	-10.47854	0.34942	2.47080
C	-11.18743	0.27681	3.71192
C	-12.50894	-0.21954	3.72848
C	-13.29837	-0.54042	2.46596
C	-13.55389	-2.06335	2.45164
C	-13.54849	-2.77386	3.69225
C	-13.20059	-4.15800	3.68007
C	-12.85876	-4.77597	2.43747
C	-11.85285	-5.80008	2.42681
C	-11.23121	-6.15708	3.66483

C	-9.83518	-6.43370	3.67146
C	-9.11849	-6.33956	2.43337
C	-7.83048	-5.70689	2.44385
C	-7.34277	-5.19531	3.68688
C	-6.74876	-3.90075	3.69390
C	-6.66874	-3.19078	4.92990
C	-6.99113	-1.79801	4.93235
C	-7.34992	-1.17581	6.16856
C	-8.39812	-0.21265	6.17436
C	-9.05827	0.09095	4.94180
C	-10.46514	0.33074	4.95103
C	-11.18202	0.26390	6.19314
C	-12.50071	-0.22077	6.17826
C	-13.01586	-0.70615	4.94934
C	-13.56297	-2.06678	4.93291
C	-13.54609	-2.78859	6.16039
C	-13.21445	-4.18490	6.14156
C	-12.86843	-4.80547	4.90717
C	-11.87069	-5.82862	4.90105
C	-11.24939	-6.19513	6.13341
C	-9.84593	-6.46464	6.14032
C	-9.12597	-6.36148	4.90996
C	-7.84910	-5.71779	4.91985
C	-7.35023	-5.20596	6.15774

C	-6.74352	-3.91280	6.16261
C	-6.67059	-3.19605	7.39786
C	-6.96733	-1.79818	7.40023
C	-7.32879	-1.17627	8.63155
C	-8.37778	-0.21286	8.63902
C	-9.05128	0.09908	7.41248
C	-10.44511	0.36470	7.42590
C	-11.15549	0.23474	8.66645
C	-12.46092	-0.27808	8.69680
C	-13.26583	-0.59339	7.44444
C	-13.53631	-2.10364	7.41065
C	-13.56083	-2.82070	8.61062
C	-13.24141	-4.22055	8.60194
C	-12.89106	-4.83782	7.36757
C	-11.89279	-5.86490	7.36527
C	-11.27144	-6.21376	8.59749
C	-9.86397	-6.46173	8.60709
C	-9.13931	-6.37070	7.38004
C	-7.86027	-5.72726	7.39015
C	-7.37044	-5.20806	8.62504
C	-6.76388	-3.91414	8.62900
C	-6.68940	-3.19813	9.86752
C	-6.97264	-1.80811	9.86895
C	-7.29887	-1.17596	11.11224

C	-8.34240	-0.18685	11.12049
C	-9.01121	0.10157	9.88449
C	-10.41014	0.31824	9.90074
C	-11.09575	0.23983	11.15346
C	-12.38520	-0.39049	11.16514
C	-12.92449	-0.84528	9.91938
C	-13.53038	-2.13408	9.88908
C	-13.61169	-2.87275	11.10272
C	-13.31593	-4.28731	11.08192
C	-12.92370	-4.87516	9.83142
C	-11.91558	-5.87515	9.82977
C	-11.30023	-6.22843	11.07415
C	-9.88207	-6.46332	11.08629
C	-9.16355	-6.34929	9.85086
C	-7.89755	-5.70846	9.85998
C	-7.40033	-5.20273	11.10572
C	-6.76925	-3.91069	11.10926
C	-6.64121	-3.20557	12.33600
C	-6.90799	-1.78591	12.33696
C	-7.21661	-1.07138	13.54223
C	-8.21041	-0.12610	13.54990
C	-8.95173	0.16503	12.35559
C	-10.37756	0.37754	12.37567
C	-11.14048	0.28759	13.58885

C	-12.35797	-0.34496	13.59567
C	-12.89402	-0.90648	12.38719
C	-13.54319	-2.19194	12.35662
C	-13.70937	-2.98530	13.54188
C	-13.46653	-4.33335	13.51373
C	-13.02830	-4.95991	12.29511
C	-11.97304	-5.95075	12.29520
C	-11.31040	-6.35117	13.50122
C	-9.95235	-6.55990	13.51349
C	-9.17850	-6.39484	12.31946
C	-7.89098	-5.73583	12.32941
C	-7.31388	-5.21695	13.53581
C	-6.70764	-3.98549	13.53833
H	-6.34492	-3.61628	-0.92919
H	-6.90977	-1.24619	-0.92657
H	-8.53522	0.24458	-0.92529
H	-10.93540	0.64801	-0.92910
H	-13.03024	-0.17901	-0.97109
H	-14.03230	-2.42129	-0.91263
H	-13.29035	-4.47025	-0.94643
H	-11.58164	-6.19975	-0.96727
H	-9.46354	-6.72591	-0.94888
H	-7.28097	-5.64298	-0.93678
H	-6.76634	-1.37787	14.48801

H	-8.52614	0.30286	14.50258
H	-10.69062	0.58216	14.53852
H	-12.84920	-0.54031	14.55083
H	-13.89345	-2.49636	14.50064
H	-13.47101	-4.89768	14.44765
H	-11.85211	-6.34258	14.44821
H	-9.44989	-6.70949	14.47087
H	-7.48976	-5.72401	14.48609
H	-6.41340	-3.54266	14.49156
C	-14.59526	0.19316	7.42532
O	-15.65380	-0.24829	7.06547
O	-14.42335	1.47420	7.80948
H	-15.28121	1.91432	7.72723
H	-16.94859	1.69573	7.41573
H	-17.82983	0.75371	5.37578
C	-16.81062	2.22366	6.47773
C	-17.29932	1.70007	5.35029
O	-16.14568	3.40022	6.47741
H	-15.99506	3.91133	5.66890

fCNTPVA02

C	-6.58825	-4.10074	0.45542
C	-7.23174	-2.79217	0.94538
C	-8.40844	-2.19258	0.51650
C	-9.02430	-2.50692	-0.75850
C	-10.36963	-2.47738	-0.90565
C	-11.23332	-2.18784	0.23062
C	-12.47842	-2.76237	0.32511
C	-12.96309	-3.74756	-0.65031
C	-13.30188	-4.97381	-0.19353
C	-13.17436	-5.26497	1.24304
C	-12.61999	-6.49229	1.72738
C	-12.06811	-7.48588	0.84818
C	-10.94570	-8.18087	1.21133
C	-10.29794	-7.91468	2.46963
C	-8.87389	-7.83221	2.58317
C	-8.04345	-7.98296	1.41315
C	-7.00978	-7.12180	1.19948
C	-6.70381	-6.09891	2.16973
C	-6.32403	-4.80040	1.80067
C	-6.27567	-3.80759	2.80270
C	-6.80993	-2.58438	2.28829
C	-7.39784	-1.65382	3.15438
C	-8.63420	-1.05509	2.74959
C	-9.21402	-1.46106	1.49370

C	-10.62639	-1.49166	1.36404
C	-11.43741	-1.18385	2.50581
C	-12.66684	-1.86736	2.68378
C	-13.28056	-2.75498	1.61000
C	-13.33341	-4.19899	2.13359
C	-13.34502	-4.42464	3.52916
C	-12.81477	-5.64380	4.03013
C	-12.26432	-6.57841	3.10498
C	-11.08808	-7.30615	3.48769
C	-10.52049	-7.05723	4.77585
C	-9.10236	-6.99226	4.89916
C	-8.30955	-7.16156	3.71237
C	-7.16431	-6.31026	3.52991
C	-6.84526	-5.37398	4.56389
C	-6.37609	-4.07903	4.18425
C	-6.56227	-2.96896	5.07203
C	-7.07169	-1.73767	4.55248
C	-7.67418	-0.80811	5.45070
C	-8.86019	-0.12270	5.04117
C	-9.43563	-0.43516	3.75243
C	-10.85434	-0.50349	3.63346
C	-11.65097	-0.25288	4.79576
C	-12.80915	-1.05544	4.99445
C	-13.16673	-2.01361	3.99381

C	-13.55389	-3.33420	4.44102
C	-13.60972	-3.59195	5.83119
C	-13.08818	-4.83151	6.34004
C	-12.50328	-5.75300	5.42224
C	-11.33330	-6.47349	5.80301
C	-10.77640	-6.23764	7.09668
C	-9.35445	-6.17540	7.22691
C	-8.54718	-6.34738	6.05218
C	-7.39895	-5.52177	5.88247
C	-7.11040	-4.53554	6.88563
C	-6.69751	-3.22920	6.47056
C	-6.86736	-2.13148	7.36434
C	-7.36019	-0.88901	6.84423
C	-7.93568	0.04912	7.74479
C	-9.10221	0.76460	7.33790
C	-9.66232	0.49788	6.04688
C	-11.09014	0.43439	5.92400
C	-11.88577	0.63286	7.08824
C	-13.02673	-0.20744	7.29254
C	-13.33519	-1.19410	6.31445
C	-13.74891	-2.49480	6.74948
C	-13.82887	-2.74990	8.14328
C	-13.33911	-3.99943	8.64981
C	-12.77077	-4.93191	7.72860

C	-11.59324	-5.65128	8.11537
C	-11.03619	-5.40827	9.40601
C	-9.61496	-5.34350	9.53812
C	-8.80429	-5.52610	8.37489
C	-7.65832	-4.68232	8.19926
C	-7.39050	-3.68674	9.18809
C	-6.99192	-2.38408	8.76170
C	-7.16464	-1.28248	9.65962
C	-7.63761	-0.04780	9.14525
C	-8.18676	0.90783	10.05758
C	-9.35509	1.64148	9.64933
C	-9.91411	1.36580	8.35505
C	-11.32528	1.29731	8.23063
C	-12.12481	1.50016	9.40402
C	-13.26205	0.64238	9.60911
C	-13.53950	-0.35777	8.61974
C	-13.94300	-1.64746	9.05271
C	-14.04864	-1.89269	10.46035
C	-13.57554	-3.15254	10.96808
C	-13.01205	-4.09035	10.03662
C	-11.84848	-4.81017	10.42329
C	-11.30092	-4.57423	11.72642
C	-9.87073	-4.50138	11.85873
C	-9.07064	-4.67166	10.68116

C	-7.94426	-3.82657	10.50264
C	-7.66922	-2.83586	11.50201
C	-7.26942	-1.52381	11.06807
C	-7.38624	-0.42638	11.96412
C	-7.85602	0.83486	11.44034
C	-8.40183	1.85608	12.28715
C	-9.51318	2.55998	11.89731
C	-10.14788	2.28115	10.64004
C	-11.58493	2.20571	10.51465
C	-12.45267	2.39978	11.64119
C	-13.53373	1.57714	11.83592
C	-13.81369	0.51575	10.91174
C	-14.21948	-0.80014	11.35522
C	-14.36448	-1.12286	12.74421
C	-13.91926	-2.32823	13.22907
C	-13.29808	-3.28061	12.35485
C	-12.12160	-4.02413	12.75042
C	-11.51935	-3.85798	14.04015
C	-10.15372	-3.78420	14.16546
C	-9.31318	-3.87337	13.00731
C	-8.17509	-3.00349	12.82076
C	-7.82909	-1.99217	13.77841
C	-7.44715	-0.74099	13.36310
H	-5.65534	-3.91575	-0.10815

H	-7.26023	-4.68185	-0.19141
H	-8.38468	-2.83006	-1.58323
H	-10.82191	-2.77990	-1.85124
H	-12.97036	-3.52638	-1.72104
H	-13.61292	-5.76340	-0.88109
H	-12.46371	-7.59652	-0.16304
H	-10.46531	-8.83385	0.48103
H	-8.33177	-8.68521	0.62936
H	-6.47074	-7.13088	0.24930
H	-8.02540	1.97883	13.30436
H	-9.99634	3.22706	12.61347
H	-12.17293	3.10232	12.42824
H	-14.08979	1.64466	12.77281
H	-14.69303	-0.35743	13.44960
H	-13.90545	-2.49131	14.30816
H	-12.14340	-3.63775	14.90817
H	-9.72408	-3.50669	15.12974
H	-8.01163	-2.16454	14.84064
H	-7.33318	0.05170	14.10474
C	-14.71494	-2.20221	1.37657
O	-15.70548	-2.72738	1.82739
O	-14.69256	-1.06213	0.70229
H	-15.58745	-0.61548	0.74255
H	-17.68165	-1.56202	2.42981

H	-18.83481	-1.62176	4.63119
H	-16.50250	-2.55185	4.44295
C	-17.91898	-0.63649	2.97420
H	-18.90884	-0.28702	2.63783
C	-17.97363	-0.94033	4.47092
O	-16.79358	0.48469	1.17279
C	-16.72077	-1.63179	5.00465
C	-16.88832	0.41861	2.60917
H	-16.84547	-1.90035	6.06742
H	-16.45083	1.35492	0.92841
O	-18.20710	0.29849	5.13750
H	-15.84244	-0.97363	4.93283
H	-18.15583	0.14115	6.08901
H	-17.18707	1.39667	3.01676

fCNTPVA03

C	-6.48689	-3.30068	0.05107
C	-6.75364	-1.95805	0.00767
C	-7.23102	-1.27417	1.18087
C	-8.26062	-0.28936	1.12809
C	-8.89521	0.09112	-0.11041
C	-10.23390	0.34177	-0.15445
C	-11.04839	0.24090	1.04117
C	-12.36903	-0.18585	0.99741

C	-12.97257	-0.71088	-0.22320
C	-13.53091	-1.94579	-0.18951
C	-13.49961	-2.72380	1.05515
C	-13.20604	-4.13265	1.06196
C	-12.84738	-4.84446	-0.12758
C	-11.91769	-5.85511	-0.08382
C	-11.28005	-6.20691	1.15027
C	-9.87364	-6.52648	1.21074
C	-9.04399	-6.52594	0.03941
C	-7.80193	-5.94531	0.07120
C	-7.32762	-5.32633	1.27732
C	-6.68470	-4.04089	1.26842
C	-6.66816	-3.29277	2.48209
C	-6.93781	-1.88806	2.44092
C	-7.30662	-1.22575	3.65299
C	-8.32567	-0.23042	3.60268
C	-8.95275	0.04730	2.33849
C	-10.34437	0.33448	2.30389
C	-11.08319	0.31579	3.53176
C	-12.41147	-0.17022	3.53852
C	-13.15858	-0.51809	2.25966
C	-13.46621	-2.02428	2.25994
C	-13.54006	-2.71171	3.50096
C	-13.27111	-4.10758	3.52660

C	-12.90607	-4.75656	2.30652
C	-11.93295	-5.81035	2.35209
C	-11.36187	-6.14947	3.62257
C	-9.96988	-6.43766	3.67996
C	-9.21181	-6.38586	2.46275
C	-7.91336	-5.77506	2.49813
C	-7.45211	-5.24281	3.74516
C	-6.81014	-3.97175	3.73792
C	-6.73948	-3.23050	4.95518
C	-6.98509	-1.81978	4.91283
C	-7.34716	-1.14875	6.11976
C	-8.35245	-0.13538	6.06948
C	-8.97165	0.15564	4.81064
C	-10.37594	0.43104	4.77514
C	-11.10497	0.38917	5.99870
C	-12.39838	-0.20664	5.98518
C	-12.92895	-0.67718	4.74595
C	-13.55515	-1.98566	4.73749
C	-13.66963	-2.68990	5.95856
C	-13.41331	-4.10477	5.98657
C	-13.02506	-4.75192	4.78033
C	-12.04364	-5.79417	4.82811
C	-11.46370	-6.12694	6.08808
C	-10.06064	-6.40138	6.14454

C	-9.30060	-6.33878	4.93798
C	-8.00676	-5.72279	4.97174
C	-7.53995	-5.18604	6.20838
C	-6.88854	-3.91324	6.20125
C	-6.81662	-3.17157	7.42294
C	-7.04361	-1.75710	7.38278
C	-7.39749	-1.08675	8.58817
C	-8.39808	-0.05988	8.53919
C	-9.00619	0.24551	7.28521
C	-10.41326	0.51073	7.25049
C	-11.15252	0.44002	8.46333
C	-12.44506	-0.18652	8.44393
C	-12.93752	-0.69948	7.21246
C	-13.59886	-1.96966	7.20496
C	-13.74352	-2.66606	8.43309
C	-13.52002	-4.08864	8.45720
C	-13.14098	-4.73646	7.24372
C	-12.14478	-5.76403	7.29474
C	-11.55946	-6.09021	8.55423
C	-10.14939	-6.35067	8.60983
C	-9.39166	-6.28293	7.40472
C	-8.10255	-5.65948	7.43785
C	-7.63373	-5.12601	8.67229
C	-6.97108	-3.85361	8.66516

C	-6.91041	-3.11333	9.88548
C	-7.12095	-1.70894	9.84711
C	-7.46154	-1.03663	11.06806
C	-8.46366	-0.00702	11.01974
C	-9.06956	0.29179	9.75201
C	-10.46756	0.54018	9.71449
C	-11.20850	0.46728	10.94203
C	-12.49818	-0.16816	10.92040
C	-12.97599	-0.68802	9.67021
C	-13.63772	-1.94479	9.66537
C	-13.80021	-2.63265	10.91361
C	-13.59569	-4.05537	10.93632
C	-13.22743	-4.70730	9.70802
C	-12.23299	-5.72472	9.75849
C	-11.64904	-6.04788	11.03008
C	-10.23388	-6.29102	11.08545
C	-9.48292	-6.20968	9.86576
C	-8.20591	-5.58682	9.89800
C	-7.73263	-5.06463	11.14760
C	-7.06186	-3.79325	11.14136
C	-6.93581	-3.06818	12.35631
C	-7.13735	-1.63251	12.31765
C	-7.46491	-0.88374	13.49211
C	-8.42317	0.10148	13.44571

C	-9.10714	0.39124	12.22230
C	-10.53712	0.63222	12.18329
C	-11.34423	0.58032	13.36394
C	-12.57702	-0.02980	13.34199
C	-13.07269	-0.62137	12.13683
C	-13.75472	-1.90290	12.13292
C	-13.97491	-2.64602	13.33456
C	-13.78675	-4.00875	13.35608
C	-13.36187	-4.70150	12.17845
C	-12.34811	-5.74072	12.22855
C	-11.72298	-6.12445	13.45533
C	-10.36596	-6.35094	13.50827
C	-9.56117	-6.20861	12.33553
C	-8.25981	-5.56745	12.36794
C	-7.70926	-5.03187	13.57494
C	-7.06350	-3.81719	13.56937
H	-6.26637	-3.83046	-0.87759
H	-6.73756	-1.44208	-0.95395
H	-8.32384	0.06720	-1.04022
H	-10.71793	0.51607	-1.11682
H	-12.87813	-0.17518	-1.17167
H	-13.93103	-2.39836	-1.09882
H	-13.20843	-4.49756	-1.09709
H	-11.55761	-6.28289	-1.02093

H	-9.45378	-6.85171	-0.91847
H	-7.24880	-5.81828	-0.86121
H	-7.07074	-1.19196	14.46218
H	-8.76501	0.55036	14.38006
H	-10.92405	0.88456	14.32425
H	-13.10177	-0.19317	14.28502
H	-14.14256	-2.12136	14.27693
H	-13.81007	-4.52916	14.31517
H	-12.28672	-6.08556	14.38912
H	-9.89138	-6.48505	14.48202
H	-7.93192	-5.50629	14.53244
H	-6.79071	-3.36063	14.52247
C	-14.47420	0.30370	2.21667
O	-15.57289	-0.14804	2.02355
O	-14.22850	1.61154	2.39760
H	-15.08385	2.07484	2.38154
O	-15.76918	-0.16712	5.92606
H	-15.86128	-0.88573	6.56265
H	-17.63406	1.52693	1.79208
H	-17.00957	0.87887	4.03349
H	-17.28157	3.75741	0.70078
H	-18.86344	3.08423	0.24286
C	-18.14826	2.42325	2.19020
C	-18.27247	3.47104	1.08978

H	-16.35120	3.23343	3.05774
C	-17.24383	1.85239	4.50632
C	-16.02710	1.06700	6.57452
C	-17.35268	2.91128	3.39938
C	-16.12807	2.14393	5.50576
H	-19.88537	1.51712	1.99418
O	-19.44480	2.04382	2.67314
H	-15.21438	1.31738	7.28564
H	-16.97940	1.03073	7.13253
O	-18.46158	1.76782	5.22468
H	-18.77253	4.37421	1.47404
H	-19.15467	1.67062	4.55107
H	-17.82866	3.81374	3.82165
H	-16.30965	3.11910	5.98993

ffcNTPVA01

C	-6.56756	-3.12023	0.01747
C	-6.88695	-1.79097	0.01903
C	-7.36128	-1.15516	1.22468
C	-8.41268	-0.20516	1.22654
C	-9.08695	0.21041	0.01630
C	-10.42856	0.43428	0.01371
C	-11.22003	0.27026	1.22421
C	-12.52826	-0.18218	1.20118

C	-13.10982	-0.72078	-0.02428
C	-13.64448	-1.96528	-0.00023
C	-13.58692	-2.75027	1.24079
C	-13.23081	-4.14951	1.21594
C	-12.88496	-4.82271	0.00287
C	-11.92109	-5.80355	-0.00894
C	-11.23310	-6.16072	1.19375
C	-9.82182	-6.45412	1.20112
C	-9.02990	-6.41137	0.00212
C	-7.80226	-5.80381	0.00873
C	-7.30238	-5.20248	1.21643
C	-6.70654	-3.90092	1.22178
C	-6.67757	-3.18182	2.45498
C	-7.00035	-1.78994	2.46026
C	-7.36704	-1.18037	3.69741
C	-8.42749	-0.22716	3.70391
C	-9.08930	0.07707	2.46379
C	-10.47854	0.34942	2.47080
C	-11.18743	0.27681	3.71192
C	-12.50894	-0.21954	3.72848
C	-13.29837	-0.54042	2.46596
C	-13.55389	-2.06335	2.45164
C	-13.54849	-2.77386	3.69225
C	-13.20059	-4.15800	3.68007

C	-12.85876	-4.77597	2.43747
C	-11.85285	-5.80008	2.42681
C	-11.23121	-6.15708	3.66483
C	-9.83518	-6.43370	3.67146
C	-9.11849	-6.33956	2.43337
C	-7.83048	-5.70689	2.44385
C	-7.34277	-5.19531	3.68688
C	-6.74876	-3.90075	3.69390
C	-6.66874	-3.19078	4.92990
C	-6.99113	-1.79801	4.93235
C	-7.34992	-1.17581	6.16856
C	-8.39812	-0.21265	6.17436
C	-9.05827	0.09095	4.94180
C	-10.46514	0.33074	4.95103
C	-11.18202	0.26390	6.19314
C	-12.50071	-0.22077	6.17826
C	-13.01586	-0.70615	4.94934
C	-13.56297	-2.06678	4.93291
C	-13.54609	-2.78859	6.16039
C	-13.21445	-4.18490	6.14156
C	-12.86843	-4.80547	4.90717
C	-11.87069	-5.82862	4.90105
C	-11.24939	-6.19513	6.13341
C	-9.84593	-6.46464	6.14032

C	-9.12597	-6.36148	4.90996
C	-7.84910	-5.71779	4.91985
C	-7.35023	-5.20596	6.15774
C	-6.74352	-3.91280	6.16261
C	-6.67059	-3.19605	7.39786
C	-6.96733	-1.79818	7.40023
C	-7.32879	-1.17627	8.63155
C	-8.37778	-0.21286	8.63902
C	-9.05128	0.09908	7.41248
C	-10.44511	0.36470	7.42590
C	-11.15549	0.23474	8.66645
C	-12.46092	-0.27808	8.69680
C	-13.26583	-0.59339	7.44444
C	-13.53631	-2.10364	7.41065
C	-13.56083	-2.82070	8.61062
C	-13.24141	-4.22055	8.60194
C	-12.89106	-4.83782	7.36757
C	-11.89279	-5.86490	7.36527
C	-11.27144	-6.21376	8.59749
C	-9.86397	-6.46173	8.60709
C	-9.13931	-6.37070	7.38004
C	-7.86027	-5.72726	7.39015
C	-7.37044	-5.20806	8.62504
C	-6.76388	-3.91414	8.62900

C	-6.68940	-3.19813	9.86752
C	-6.97264	-1.80811	9.86895
C	-7.29887	-1.17596	11.11224
C	-8.34240	-0.18685	11.12049
C	-9.01121	0.10157	9.88449
C	-10.41014	0.31824	9.90074
C	-11.09575	0.23983	11.15346
C	-12.38520	-0.39049	11.16514
C	-12.92449	-0.84528	9.91938
C	-13.53038	-2.13408	9.88908
C	-13.61169	-2.87275	11.10272
C	-13.31593	-4.28731	11.08192
C	-12.92370	-4.87516	9.83142
C	-11.91558	-5.87515	9.82977
C	-11.30023	-6.22843	11.07415
C	-9.88207	-6.46332	11.08629
C	-9.16355	-6.34929	9.85086
C	-7.89755	-5.70846	9.85998
C	-7.40033	-5.20273	11.10572
C	-6.76925	-3.91069	11.10926
C	-6.64121	-3.20557	12.33600
C	-6.90799	-1.78591	12.33696
C	-7.21661	-1.07138	13.54223
C	-8.21041	-0.12610	13.54990

C	-8.95173	0.16503	12.35559
C	-10.37756	0.37754	12.37567
C	-11.14048	0.28759	13.58885
C	-12.35797	-0.34496	13.59567
C	-12.89402	-0.90648	12.38719
C	-13.54319	-2.19194	12.35662
C	-13.70937	-2.98530	13.54188
C	-13.46653	-4.33335	13.51373
C	-13.02830	-4.95991	12.29511
C	-11.97304	-5.95075	12.29520
C	-11.31040	-6.35117	13.50122
C	-9.95235	-6.55990	13.51349
C	-9.17850	-6.39484	12.31946
C	-7.89098	-5.73583	12.32941
C	-7.31388	-5.21695	13.53581
C	-6.70764	-3.98549	13.53833
H	-6.34492	-3.61628	-0.92919
H	-6.90977	-1.24619	-0.92657
H	-8.53522	0.24458	-0.92529
H	-10.93540	0.64801	-0.92910
H	-13.03024	-0.17901	-0.97109
H	-14.03230	-2.42129	-0.91263
H	-13.29035	-4.47025	-0.94643
H	-11.58164	-6.19975	-0.96727

H	-9.46354	-6.72591	-0.94888
H	-7.28097	-5.64298	-0.93678
H	-6.76634	-1.37787	14.48801
H	-8.52614	0.30286	14.50258
H	-10.69062	0.58216	14.53852
H	-12.84920	-0.54031	14.55083
H	-13.89345	-2.49636	14.50064
H	-13.47101	-4.89768	14.44765
H	-11.85211	-6.34258	14.44821
H	-9.44989	-6.70949	14.47087
H	-7.48976	-5.72401	14.48609
H	-6.41340	-3.54266	14.49156
C	-14.59526	0.19316	7.42532
O	-15.65380	-0.24829	7.06547
O	-14.42335	1.47420	7.80948
H	-15.28121	1.91432	7.72723
O	-14.23459	1.34245	10.98546
H	-15.09249	1.78255	10.90316
C	-14.40659	0.06145	10.60126
O	-15.46509	-0.38005	10.24146
H	-18.00173	0.68169	8.35927
C	-17.47123	1.62809	8.33377
H	-17.12053	1.62369	10.39917
C	-16.98253	2.15169	9.46117

O	-16.31763	3.32819	9.46087
H	-16.16703	3.83929	8.65237

ffCNTPVA02

C	-6.49761042825635	-2.65962777883953	0.04916797358557
C	-6.98132047338979	-1.36598735395623	0.04589490312172
C	-7.52568701201737	-0.79359750206061	1.23063864138105
C	-8.74458158730102	0.01204009662923	1.20805321653927
C	-9.45402613680515	0.26783897494299	0.00002309704349
C	-10.83333954513465	0.20508035982855	-0.03128861516513
C	-11.57068186868354	-0.11635675913566	1.14406535711008
C	-12.71146696844839	-1.02796644019961	1.11325291363533
C	-13.15054046327680	-1.64259637881278	-0.09371938216407
C	-13.51954117778780	-2.97308313897608	-0.10980030051466
C	-13.46716446671126	-3.75398492870423	1.07994335213934
C	-12.95531995975849	-5.12286948639640	1.08218439329714
C	-12.47938089779397	-5.74876805286201	-0.10495908235544
C	-11.32703011125515	-6.51010327175271	-0.08400577775428
C	-10.59470942583826	-6.68222734603727	1.12508148896598
C	-9.13531483957685	-6.61617243500521	1.15861620686422
C	-8.36709910821712	-6.37707719125644	-0.01612107209431
C	-7.28810143057316	-5.51570692762157	0.01370941162684
C	-6.92495484690009	-4.85158134766597	1.21970272686844
C	-6.53512222159468	-3.44361982515805	1.23720253238493

C	-6.64817463223735	-2.73923613590743	2.46400385887042
C	-7.15043460372492	-1.39407825943754	2.46066621797994
C	-7.62663741120875	-0.84339242349855	3.70137999911572
C	-8.81404778597524	-0.05744833310793	3.67921801540284
C	-9.47537722107338	0.14349880587391	2.41740679377682
C	-10.90958131700230	0.07762754145462	2.38483511437002
C	-11.60522373641778	-0.18558081060847	3.61606946463079
C	-12.71657004496016	-1.07440112069229	3.58602063140587
C	-13.08727890987561	-1.66107030412192	2.32608821064474
C	-13.47137964634009	-3.04547961548833	2.30932996968845
C	-13.46271846614703	-3.76863412327598	3.55305256145986
C	-12.96583137757771	-5.10324592957236	3.55544026515288
C	-12.49540118200031	-5.65719540233671	2.31396514004194
C	-11.29719876780605	-6.44870045011992	2.33581299665617
C	-10.63455297018896	-6.64363875895531	3.59787132853164
C	-9.21243758693862	-6.57782843351871	3.63049506035482
C	-8.51328125612679	-6.32150331204345	2.39967830322864
C	-7.39173096176919	-5.42568960635235	2.43070561408003
C	-7.02936299358331	-4.83401744015222	3.69084787588590
C	-6.64958292989530	-3.46182456530807	3.70792883933295
C	-6.68594000946028	-2.75223518263487	4.94074861118186
C	-7.19081414790723	-1.39772831062506	4.93748681231523
C	-7.67071248385741	-0.84807032117701	6.15749319394721
C	-8.86390104999574	-0.05676209008475	6.13497456140370

C	-9.52560775169823	0.14930506146219	4.89376075715650
C	-10.96955238701837	0.08122102127898	4.86091023824864
C	-11.66378926592206	-0.18619223377184	6.07120260729122
C	-12.77638514966896	-1.08528849065519	6.04107974501767
C	-13.15545205226150	-1.66932287003191	4.80205799272428
C	-13.54228370677149	-3.06245311446149	4.78507378009914
C	-13.53068155534216	-3.78674066512189	6.00732059298019
C	-13.03299233111793	-5.12912435444813	6.01046821141029
C	-12.56559620596794	-5.68747054291451	4.78980402376745
C	-11.35929508605669	-6.48421102923855	4.81191574536560
C	-10.69326119421257	-6.67401162949465	6.05340713600090
C	-9.26345332206619	-6.60706996517901	6.08610583591396
C	-8.56182292981448	-6.35423639336800	4.87603269157838
C	-7.43319088469671	-5.45187900090437	4.90723617944540
C	-7.07339936312396	-4.85621431714487	6.14661119091567
C	-6.69173396139919	-3.47646430512349	6.16386759377269
C	-6.75146869857669	-2.76301473845387	7.40935174134459
C	-7.25085180016254	-1.42108692224965	7.40635592398002
C	-7.71757732008669	-0.86111878107795	8.62691742870801
C	-8.92174159388427	-0.06110817548645	8.60427188123733
C	-9.58684764664336	0.12959933743931	7.36221985243822
C	-11.01659101187788	0.06298671311915	7.32899492710767
C	-11.71720762430336	-0.18846058006017	8.53879025822580
C	-12.83763707766182	-1.09974651281761	8.50878146548702

C	-13.19811344649828	-1.69720546020429	7.27101772025082
C	-13.58676342979127	-3.07452989651991	7.25350354261349
C	-13.59466461467225	-3.79933582137245	8.47626984428633
C	-13.09302991178858	-5.15487660480217	8.47932725330084
C	-12.61215212681102	-5.70257710501727	7.25899584485051
C	-11.41684292491161	-6.49072871342065	7.28095521825350
C	-10.75516809632477	-6.69636505528199	8.52236249298387
C	-9.31155769948067	-6.62940405400960	8.55504262744956
C	-8.61644910466084	-6.36033925391838	7.34476341033939
C	-7.49893536566735	-5.46613183049378	7.37555778716687
C	-7.12467303380698	-4.87998196075575	8.61517757473052
C	-6.73989107800342	-3.48674845592241	8.63272969946989
C	-6.82200289576919	-2.77954412847045	9.86474367618993
C	-7.31908774910493	-1.44495614335830	9.86195929482399
C	-7.79030447251834	-0.89029728357658	11.10328701874990
C	-8.98651209026692	-0.09580662339889	11.08086969587259
C	-9.64671282616015	0.10110525305729	9.81805230270377
C	-11.06883803540947	0.03657355237218	9.78412388014308
C	-11.76932028063103	-0.22017340822154	11.01363443529033
C	-12.88414075406612	-1.12239804814255	10.98370277305357
C	-13.23706427988241	-1.72045917946608	9.72383626382811
C	-13.62723943553748	-3.08933232608458	9.70793217576982
C	-13.63153277403779	-3.80940034917420	10.95273568162408
C	-13.13122299097280	-5.15554469013150	10.95653575614232

C	-12.65585981504905	-5.70748221080955	9.71550960773264
C	-11.46724881122040	-6.49159665851784	9.73727194669709
C	-10.80624643743265	-6.69243742864459	10.99915799182662
C	-9.37232999837973	-6.62687918515200	11.03140823964726
C	-8.67667895616907	-6.36303081810289	9.80024230338274
C	-7.56541168739470	-5.47361108959720	9.83072716928862
C	-7.19611472291098	-4.88660808561923	11.09098284562396
C	-6.81478087048350	-3.50249206560014	11.10847267177547
C	-6.82007400235484	-2.79406028481999	12.33822098969259
C	-7.33257730204616	-1.42534491321365	12.33563885790166
C	-7.80977547103341	-0.79953065497606	13.52256645144150
C	-8.96104389558666	-0.03619874102469	13.50092020592080
C	-9.69074775845218	0.13887036687474	12.29098080759804
C	-11.15027940343418	0.07525487980012	12.25537538052271
C	-11.92348980194350	-0.15905171459714	13.42798302491108
C	-13.00279762683310	-1.02042740206311	13.39852386120046
C	-13.35951927534641	-1.69200803663612	12.19433488975318
C	-13.74507278561267	-3.10214210672912	12.17839766515799
C	-13.78007168471018	-3.88467062564335	13.36741675747446
C	-13.29603128287487	-5.17867998270096	13.37150182448581
C	-12.75438543816765	-5.75400890251200	12.18692551754991
C	-11.53656582310949	-6.56168501978745	12.20894900904170
C	-10.82726134825374	-6.81810286074515	13.41666520032129
C	-9.44808860041564	-6.75588639697811	13.44763533082834

C	-8.71176137169888	-6.43341076067447	12.27238846889187
C	-7.57102620454740	-5.52130736221319	12.30355611783112
C	-7.13391720256008	-4.90640894988436	13.51087802511075
C	-6.76771707165710	-3.57491218218633	13.52777292474688
H	-6.24443257019542	-3.12587908921553	-0.90471410738089
H	-7.09447171654918	-0.85213847889951	-0.91041654680453
H	-8.91240454659004	0.34865576426180	-0.94419357522793
H	-11.33652776660378	0.24017865698910	-0.99889775427759
H	-13.04186187281893	-1.11783299780199	-1.04443144731980
H	-13.69008952681277	-3.45668271750703	-1.07266436313322
H	-12.92229622853408	-5.49643411234043	-1.07011509875794
H	-10.89776752278093	-6.83536163845870	-1.03328423381432
H	-8.72206404089784	-6.73779046622628	-0.98319502726728
H	-6.82527245388524	-5.22432824444369	-0.93074276616842
H	-7.36846477099906	-1.05301790868151	14.48814559287749
H	-9.39255886378560	0.28720741129249	14.45028056986756
H	-11.57165983918649	0.20458418295074	14.39491118207076
H	-13.47007403794251	-1.30564499130674	14.34247291944193
H	-14.03089446151481	-3.41721157442088	14.32129038158805
H	-13.18054335662640	-5.69060493568146	14.32868738994223
H	-11.36878160214818	-6.90021010541450	14.36087570298963
H	-8.94434259168723	-6.78950552622023	14.41545503046721
H	-7.24469585472201	-5.43065156003750	14.46178293077051
H	-6.59911608228355	-3.09130650681909	14.49134716062752

C	-15.96647311077863	-0.50410143822442	6.33290686117984
O	-16.40955752194420	-1.48993186223034	5.91752000550887
O	-15.53934875635014	0.49261567289052	6.74624735051084
H	-16.41902901248158	2.93772320077588	7.44617444385587
C	-16.73233613307291	3.85977126542246	7.94178827564547
C	-17.69120308120519	4.64772117179051	7.06678045910481
H	-15.83812476695642	4.44589163029166	8.15731139084203
H	-17.19923401081791	3.59271255384674	8.89256494000081
O	-18.07827974499905	5.89116570450356	7.64879635219607
H	-18.57555495003977	4.04301436253125	6.82854482889048
H	-17.21332682036275	4.90937085094956	6.12208232367955
H	-18.52591639597875	5.71797524639414	8.48270036480062
O	-14.76472084268416	1.36039758999745	9.91202199404987
H	-16.00686930572353	2.65548203427192	12.22625088232061
C	-15.47583769135949	0.45435160983261	9.77261029406133
O	-16.20024277081007	-0.44243999366037	9.63973269781323
H	-16.13783634662505	4.09228353952752	13.25534497699188
C	-16.69725158918994	3.26888281867403	12.80831839235894
H	-17.35928011291879	4.39770599675923	11.10567293437757
H	-17.10521562467085	2.65115195518193	13.61414360308120
C	-17.79725780969587	3.80629098059434	11.90972619006385
O	-18.69395320081501	4.68749166593836	12.57895390055536
H	-19.12154940020004	4.20629617060735	13.29322272740279
H	-18.34629284557276	2.97814269381846	11.44470058977833

ffCNTPVA03

C	-6.02289501202555	-3.49149929738735	0.17687003651779
C	-6.05224661401623	-2.11645667482597	0.20780655683203
C	-6.41341389105715	-1.42523433606707	1.40760407939234
C	-7.28774298106604	-0.26623051167257	1.39071437117863
C	-7.83721187730793	0.25188407626029	0.17529310630287
C	-9.15281089696563	0.65235005897544	0.11867210463455
C	-9.99126585894937	0.55497909806966	1.27148474143812
C	-11.37012501016502	0.10541938146243	1.19197793829520
C	-11.96384482725142	-0.29829573615444	-0.04288709067148
C	-12.76421025361102	-1.41776795945643	-0.09572712201892
C	-13.00939064051166	-2.19141516480373	1.08146896387209
C	-12.96834588579813	-3.64928376393613	1.05655082892240
C	-12.70212110556206	-4.37300523809746	-0.14109970807890
C	-11.86130370614980	-5.46813856307792	-0.13071255145260
C	-11.24512234984339	-5.89602915903907	1.08123663533589
C	-9.86089387830757	-6.33546995934964	1.13307207062522
C	-9.02887167009909	-6.34737311473116	-0.02915297086507
C	-7.72531030416434	-5.91100863241765	0.03988114907821
C	-7.18434761845536	-5.43742163950175	1.27626340066089
C	-6.35125000798818	-4.25133541175361	1.34366169575705
C	-6.24493623070922	-3.58213338171325	2.59324785065197
C	-6.28048901383040	-2.14539170170126	2.62457417916686

C	-6.59229307908897	-1.50435882988344	3.87207947435183
C	-7.45769588172494	-0.37925684387607	3.85557018610156
C	-7.96857497996035	0.07218698965126	2.59327375647291
C	-9.34231117186391	0.48664587799135	2.52945705585797
C	-10.12209860197766	0.44668107328614	3.73525586204375
C	-11.47086767418148	0.02499929574273	3.65805419674793
C	-11.98504217536163	-0.37298529079423	2.38011678253319
C	-12.81914316179367	-1.53984924699778	2.32450063908660
C	-13.07279337927484	-2.24151107835418	3.55990642314587
C	-13.00704473785670	-3.67188143557727	3.53027057307027
C	-12.72267005570862	-4.32461057447522	2.28337950550866
C	-11.85394379559677	-5.46812056432474	2.29486177742228
C	-11.32217798351647	-5.91073175180903	3.55129478129591
C	-9.96878372533481	-6.34821898185743	3.60267622271635
C	-9.19975957519946	-6.31749323992054	2.39140686046436
C	-7.83886509623874	-5.86155271632736	2.46431277067970
C	-7.32651690307747	-5.45960686168015	3.74437212505406
C	-6.51565402566136	-4.29497470075278	3.80922741733100
C	-6.35392466113771	-3.63977001876007	5.07019751359709
C	-6.39676276301702	-2.20630894497587	5.10128264079825
C	-6.70912805466247	-1.56025297051103	6.33285693781772
C	-7.59244715432138	-0.43264627872989	6.31417895402270
C	-8.11341778534396	0.00486623605802	5.06997230223965
C	-9.48114810000293	0.43283235352747	5.00805639247970

C	-10.28315652149916	0.41514968272817	6.19635488937279
C	-11.65883538100251	0.07586379118911	6.09928028420158
C	-12.15013736814753	-0.35769068703495	4.85458335276540
C	-12.96252129377521	-1.56271604783392	4.79592847355774
C	-13.15040037033477	-2.28509717429204	6.01791480833596
C	-13.08648480771855	-3.71182996422103	5.98663333903084
C	-12.81578952355124	-4.37350766067615	4.75005084958033
C	-11.96810627552250	-5.53151963485819	4.76482135767667
C	-11.44032737787103	-5.98136284255930	6.01123626073193
C	-10.08019915559048	-6.42272682997513	6.06484048309375
C	-9.30571898387732	-6.39024980894563	4.86686144075084
C	-7.94671372533208	-5.93628594296593	4.94103917526982
C	-7.42891251618208	-5.53495557377460	6.20822228788172
C	-6.61363130808341	-4.35852133717449	6.27214886787261
C	-6.47542778889351	-3.69123337148938	7.53349561614977
C	-6.52839487339951	-2.26768286494347	7.56118669671327
C	-6.84716184854139	-1.61581863889526	8.79717454698620
C	-7.72290639221849	-0.49932094488570	8.78072103372029
C	-8.27176752658995	-0.06506742804433	7.52621323597729
C	-9.61692927754480	0.37070518966582	7.46736849924387
C	-10.40196766415195	0.32925964699586	8.68105802817780
C	-11.74913343880690	-0.01088761552471	8.63026865451340
C	-12.51919708807043	-0.18386049769453	7.33329090767441
C	-13.05426287622513	-1.62127880367787	7.26884707977281

C	-13.26260677789958	-2.33176049652792	8.45289181381365
C	-13.20726547827999	-3.76397500667014	8.43693580767814
C	-12.91786007761843	-4.42223828541990	7.21173785879109
C	-12.07970044712881	-5.58526777287524	7.22803122529881
C	-11.55410617622708	-6.02293235339762	8.47491254007008
C	-10.19645127580451	-6.46879293980100	8.53265305301717
C	-9.41766544244285	-6.44526508262905	7.33524735911867
C	-8.06366369296878	-5.99194309450020	7.40819279764601
C	-7.54968162685961	-5.58055658531147	8.67768062296489
C	-6.73664302165680	-4.40928233657951	8.74184682780958
C	-6.60284788197590	-3.73918032268433	10.00086689252728
C	-6.65347275430532	-2.31959088050510	10.02991809892303
C	-6.94095659080048	-1.66920057960261	11.27273028141688
C	-7.81846948876219	-0.53064279638197	11.25825038786570
C	-8.36652400020520	-0.11488224979288	10.00162615371509
C	-9.71749602711360	0.30798841989732	9.95322548180103
C	-10.47171318025250	0.31132746867299	11.16467854678351
C	-11.83648283223891	-0.12670269035107	11.09924143286548
C	-12.36470550125730	-0.49736613968310	9.82516293613466
C	-13.16821737525086	-1.66634749694494	9.74419011954371
C	-13.43566006484159	-2.38772395915957	10.94110323196413
C	-13.37410097148304	-3.83280217997705	10.91175860937008
C	-13.03513043803261	-4.46679367192705	9.66984490375620
C	-12.19074973370117	-5.60672511445159	9.69042435484599

C	-11.68086876703766	-6.05525546715498	10.95096896140869
C	-10.31526965573934	-6.50063406903302	11.01014761767384
C	-9.53902803800590	-6.47350589603725	9.80364711902714
C	-8.19211234267098	-6.02760855252773	9.87736647665206
C	-7.67535741786066	-5.63032647415222	11.15460654331449
C	-6.85410106255956	-4.45210750903343	11.21783389594341
C	-6.67458519742796	-3.79812643503060	12.47006810478151
C	-6.71473599368094	-2.35780918225381	12.49848076785296
C	-6.97564842889536	-1.62706506371079	13.70750004360289
C	-7.80872664054160	-0.53883942272507	13.69554294609807
C	-8.43652752440315	-0.11516236806558	12.47339225431076
C	-9.80563604587781	0.31815654635190	12.42621685167165
C	-10.64054193188183	0.33640118354595	13.59713468377300
C	-11.94061841607287	-0.09227028109878	13.53306109554999
C	-12.48558972924941	-0.56484050605404	12.28847047298150
C	-13.32757147014176	-1.72741400264979	12.20720933645791
C	-13.67247202641950	-2.50052408581234	13.37645444625617
C	-13.62872306543579	-3.86551379955973	13.33626538598058
C	-13.23060015060665	-4.54561157109063	12.12602701617626
C	-12.35104525467225	-5.69044479635518	12.15196766081367
C	-11.80437412567647	-6.20005222596155	13.37578359562374
C	-10.49870282251615	-6.62085238747792	13.43340357810991
C	-9.66022377691867	-6.55531026286834	12.27139927164150
C	-8.28811736893150	-6.11025830238488	12.34574856819746

C	-7.68794802194744	-5.71061427141207	13.58639540358218
C	-6.90231968305677	-4.58746636103527	13.64749177040219
H	-5.90342736707083	-3.99459451512781	-0.78437863631575
H	-5.94798061224319	-1.56525819827201	-0.72845753623548
H	-7.26536261865751	0.18690785530297	-0.75218536038556
H	-9.58676076477857	0.90521093716047	-0.85019421758142
H	-11.66074228264597	0.17802406689385	-0.97704249551345
H	-13.07361820011728	-1.79727471567232	-1.07118253869919
H	-13.02514043272389	-3.97130794807702	-1.10323769189478
H	-11.55132996698538	-5.90095829690736	-1.08350179760361
H	-9.46540623249649	-6.54849209333233	-1.00917295614021
H	-7.16258445673530	-5.78198886119497	-0.88639316724510
H	-6.62568136956914	-2.01791328049623	14.66473148575885
H	-8.10215925976429	-0.08305785440614	14.64286594738411
H	-10.20197811608334	0.55424141628920	14.57262356732006
H	-12.51154390772281	-0.20616540489549	14.45621339080948
H	-13.83920866194229	-1.99655214636816	14.33045836769347
H	-13.77309142109269	-4.43361860255815	14.25685384990426
H	-12.37591638030572	-6.12056401844800	14.30209388418602
H	-10.06373143833852	-6.86480016287910	14.40419111539921
H	-7.97517770351993	-6.20780188733691	14.51473147022017
H	-6.57758178177629	-4.21852805870166	14.62202141782694
C	-13.66636725633075	0.87567657657495	7.35110546614782
O	-13.56479007310545	1.93099240867800	7.91643568815218

O	-14.73760563527531	0.45784246768225	6.68323267326095
H	-15.40237879942919	1.16756382567448	6.73237934636099
H	-7.99414246063551	4.73376578138222	3.42813365750030
H	-7.64794119278794	2.99637455045872	1.99049375329125
C	-8.81877434217569	4.22030525167346	2.92000637901409
O	-8.50926044638936	3.41511436466632	1.86241210724126
C	-10.21468206030037	4.73935146803506	2.91175620605005
H	-10.48188330902082	5.08661851663195	1.89298764670792
H	-10.30114974965208	5.59937893686190	3.59491013664468
C	-11.23041635412507	3.66761996591388	3.34367924098700
O	-10.99137377130242	3.30464622222299	4.70723480939184
H	-10.09106670480360	2.95535532618685	4.77864483224807
H	-11.07808827451085	2.78132893401381	2.70108262535347
H	-12.87692852025608	4.42138302694469	2.20080647591975
C	-12.68960873802320	4.09136371734630	3.23624827125447
H	-12.87517680390543	4.95369579274938	3.90109204445760
C	-13.66409665009832	2.95646589786775	3.58992358036691
H	-13.39023466397469	2.08446348700725	2.95728600839194
O	-13.57725132276961	2.59929536303110	4.95660435773222
H	-15.27504468713762	3.51167318470008	2.23006856487729
C	-15.11386244642312	3.31788220129189	3.30260689220058
H	-15.40662332086524	4.21291485170709	3.87508643687209
H	-12.64861725651656	2.71343141766251	5.22724273007348
H	-15.76923613787745	2.48800555316179	3.60942106023470

C	-15.80989704111590	0.03902207092247	9.78515593009997
O	-16.53574268446866	0.66368224177927	9.08546206591352
O	-15.84777626541906	-0.05223306671235	11.10726439525825
H	-15.13077670272631	-0.64110536374113	11.41195172803394

CNTPVA01Zn

C	-6.54546905165886	-3.01027054431084	0.18978917432595
C	-6.78049039329901	-1.66130729602003	0.20978027160799
C	-7.23240043177407	-1.02513861025851	1.41793045269247
C	-8.27063241457167	-0.03073391614034	1.41175470300365
C	-8.93618371337018	0.37870263803801	0.20344412739417
C	-10.29415482496178	0.55783855437526	0.18914422264024
C	-11.07481005243796	0.33501879029590	1.37772200338595
C	-12.33985465620889	-0.35025749454081	1.34521656796170
C	-12.90354249237350	-0.85113810366344	0.12301693532921
C	-13.50082555592498	-2.08529901173482	0.08674037141911
C	-13.56708604124044	-2.89695660580629	1.26929969038310
C	-13.32087458754965	-4.31796611301098	1.23851224646389
C	-12.98016199832390	-5.00326121547442	0.02542838760826
C	-11.99094808418614	-5.95531049586604	0.01828939354969
C	-11.28252061444251	-6.27450860076662	1.22370467576604
C	-9.84920813282991	-6.46320810808717	1.24299492719637
C	-9.05311953201519	-6.32937734886834	0.05920216107409
C	-7.84704492306815	-5.67206026355826	0.09756968188146

C	-7.36908370882335	-5.10627314043008	1.32423978471291
C	-6.73537796419028	-3.80720232164872	1.37353679445690
C	-6.69893874463127	-3.12529882548860	2.61429061088533
C	-6.94587177411432	-1.70270632310884	2.64191372801912
C	-7.31895330789283	-1.10809375557350	3.88265586173977
C	-8.32805295370704	-0.10394553163650	3.87676779974327
C	-8.95529056317819	0.23007253847879	2.63203767974312
C	-10.38194053190784	0.41550784595567	2.61981706608301
C	-11.09499723488356	0.23576679794120	3.84795090863661
C	-12.33839860652498	-0.44655275296189	3.81657932235084
C	-12.82224330555715	-0.92653383440981	2.55605547478722
C	-13.44849900423307	-2.22032039190623	2.51685171013972
C	-13.55661989738124	-2.95880533113434	3.74002550940228
C	-13.31593552755507	-4.35921816018792	3.71002345590922
C	-12.96861738781342	-4.96332241586645	2.45739130296000
C	-11.93296896192344	-5.96070964678350	2.44970739984599
C	-11.30759339971273	-6.29790392731009	3.69584552308563
C	-9.89873416570187	-6.48673052634749	3.71504964641878
C	-9.17374481183023	-6.32664551695632	2.48710580261972
C	-7.91404759693290	-5.63487201364350	2.52770485613529
C	-7.45155759305543	-5.14531169879816	3.79341417829368
C	-6.84089515281563	-3.86343551141526	3.83816064236226
C	-6.76185495394804	-3.18712281708873	5.09392700519965
C	-7.00923979752909	-1.77637497419555	5.12936865590454

C	-7.34650617316977	-1.17345210419954	6.35598235950144
C	-8.27033115745377	-0.00588729129709	6.37170773324778
C	-9.00921819170630	0.18452359852567	5.11271738596291
C	-10.40148371275524	0.34638525148856	5.10200554017858
C	-11.12535907430655	0.17146540945103	6.33705552008188
C	-12.37020742163414	-0.50697445827820	6.29595994877063
C	-12.84971265529397	-1.00094739199626	5.03659771951689
C	-13.48071738891643	-2.27377937057559	4.99539178765295
C	-13.60487447064378	-3.02129772332384	6.21119992647823
C	-13.36751658362524	-4.42765519248936	6.17875566282888
C	-13.00704734830082	-5.03263913851239	4.93519135418905
C	-11.98421312398436	-6.03015456767030	4.92768025728235
C	-11.35644171480156	-6.37649036860600	6.16337897146837
C	-9.93930919950211	-6.56894565477952	6.18234582043552
C	-9.21017182600133	-6.40209734661666	4.96595248705952
C	-7.95281575505920	-5.71828074314227	5.00625003129413
C	-7.48152534340025	-5.22899881576930	6.25777512915803
C	-6.87637815677613	-3.93129616415414	6.30177331747896
C	-6.81169069937184	-3.24513813520024	7.55482513362670
C	-7.05067895738753	-1.83407580272269	7.58608143035278
C	-7.37758908832797	-1.21286031116898	8.83204140496860
C	-8.39949861983208	-0.18270604516504	8.84679982006789
C	-9.01636110867022	0.17611560774703	7.62767122069622
C	-10.44266426871092	0.30612188684259	7.59189196738411

C	-11.17716226258775	0.12722803827366	8.80375120516222
C	-12.43586115586992	-0.56155258215230	8.76111051981075
C	-12.90094504925635	-1.05376775838338	7.51270641484508
C	-13.53212515851878	-2.34021823561043	7.46680385572514
C	-13.65528647138426	-3.08304718725396	8.67713565233532
C	-13.41589225313642	-4.49685877117869	8.64537741625572
C	-13.05637242576340	-5.09953413906644	7.40641405511614
C	-12.02646428086113	-6.09635090978367	7.39808823277268
C	-11.40029117673920	-6.43968055352292	8.63238687105342
C	-9.97830044133937	-6.63432179740824	8.65224466821844
C	-9.25180408995321	-6.47054353699877	7.43615474747893
C	-7.99678352753923	-5.78198450539641	7.47453720474022
C	-7.52618023080516	-5.28630090598600	8.72581238059697
C	-6.91655697621254	-3.98661679643932	8.76855886809795
C	-6.85010621904364	-3.30012732867617	10.01270494071917
C	-7.08204733358795	-1.89077055347738	10.04352206193073
C	-7.42712919740667	-1.29103716648743	11.30827964954877
C	-8.46629999198550	-0.29781125594250	11.32285831219004
C	-9.09176278054308	0.04467158436811	10.07783252939115
C	-10.49865052073819	0.22306561988947	10.05650121338095
C	-11.22778838432108	0.06300899381016	11.28467611302299
C	-12.48706158808937	-0.62976317986811	11.24101967208535
C	-12.94452416026095	-1.12553329317103	9.97447473606215
C	-13.56360789554853	-2.40257599320698	9.93080062536384

C	-13.69608973449450	-3.14080751061159	11.15552734266576
C	-13.44795257997234	-4.55699059079780	11.12390917791552
C	-13.08412209975384	-5.15465995999800	9.87059053493461
C	-12.06266297813018	-6.14232943425674	9.86347103280024
C	-11.44256194474029	-6.48907594803745	11.11142527292390
C	-10.01753046846999	-6.67666371190344	11.13087886596931
C	-9.29582839941377	-6.51239444223397	9.90040744701607
C	-8.04936723053421	-5.82747929669168	9.93744081141742
C	-7.57654565483907	-5.33570821056678	11.19964582177616
C	-6.95780759440079	-4.03992859331810	11.23933194123427
C	-6.81971898124695	-3.36911576976417	12.48492589867646
C	-7.06607103924576	-1.93318818008598	12.51834726720819
C	-7.41618413084332	-1.26289809121480	13.73190620857946
C	-8.41289397353883	-0.31354264347104	13.74733238802567
C	-9.11739309560689	0.01351553849310	12.54731720365244
C	-10.55670811046384	0.20861670222468	12.52659000000484
C	-11.35301406952498	0.07723963108231	13.70787681754846
C	-12.56077313006942	-0.58017524020379	13.66800937245372
C	-13.03572594655670	-1.15095764143290	12.44478312948448
C	-13.66693085516238	-2.45645315316475	12.39957854052460
C	-13.84333760295442	-3.25183096584111	13.57594020861432
C	-13.60480809704978	-4.60621862672129	13.54670320038035
C	-13.17205419757946	-5.24058120888257	12.33933008196456
C	-12.12794925233636	-6.24824344525937	12.33264506578133

C	-11.46537299639988	-6.65578684163036	13.53253781663188
C	-10.10093706659260	-6.83636558752722	13.55121942127685
C	-9.32515581548819	-6.61578287424894	12.37091047633269
C	-8.05069669811831	-5.91854243654089	12.40741221196437
C	-7.49686386402519	-5.41496300118464	13.62112065478360
C	-6.89280044525604	-4.17498338718024	13.65896461515296
H	-6.34067397630249	-3.49905684984199	-0.76461320092550
H	-6.76339263365064	-1.10044266237657	-0.72620089269088
H	-8.38311854817285	0.41237111627326	-0.73678688614188
H	-10.79677947229739	0.72920088879608	-0.76447090824537
H	-12.73401948794745	-0.31579782981310	-0.81307679263347
H	-13.79239820350983	-2.50567025287662	-0.87745533881779
H	-13.39939420543108	-4.66815189484590	-0.92513765547363
H	-11.64560577075414	-6.35364566612769	-0.93749654443294
H	-9.46771479185016	-6.61530418154933	-0.90925878760579
H	-7.33335660404746	-5.45321987518624	-0.84020641958032
H	-7.00667644021731	-1.61011808208084	14.68229502141393
H	-8.76638466165233	0.06495325897340	14.70807708640126
H	-10.93972410129627	0.36231251769349	14.67721970600271
H	-13.07390837102951	-0.79899082709296	14.60609376932409
H	-14.01934651134063	-2.76827704642134	14.53859784131823
H	-13.59596413686051	-5.16111170081721	14.48659292298285
H	-12.01161176867606	-6.67225323790545	14.47747934500154
H	-9.60259023828805	-6.99002298650131	14.51014783154135

H	-7.68694308569706	-5.93388810617125	14.56251381607343
H	-6.62411657066988	-3.75178637788781	14.62840460394107
C	-5.67387832536782	2.74192276309033	5.19822170939646
C	-5.39126102991633	2.82202126792407	3.88337972593835
O	-5.91763623268157	2.12206071026542	2.86100278955047
H	-4.64146680411326	3.52696512939313	3.49984078837131
H	-6.59867064210360	1.50389271072440	3.17551321342374
H	-5.11131373897242	3.41791545066706	5.84985562213703
Zn	-6.94416553713789	1.51653974986064	5.95636421732733

CNTPVA02Zn

C	-6.05101525702264	-4.63819743854571	0.70771593267182
C	-6.00361200475015	-3.27531181660163	0.62185281485263
C	-6.41571558109826	-2.45973824997232	1.74083286778763
C	-7.21354874647509	-1.28202452872412	1.57196404266601
C	-7.66039482467185	-0.83924593028878	0.27270853678889
C	-8.93710185723469	-0.38387883640556	0.10151030402402
C	-9.85204364487975	-0.33784117321363	1.21741107632990
C	-11.21891130124139	-0.74143585609460	1.09669490136610
C	-11.77000794203345	-1.21704603809497	-0.15009472939959
C	-12.60386158141922	-2.29847296209337	-0.16657693189763
C	-12.94174076290731	-2.97651657990771	1.06254152598874
C	-12.98788067477660	-4.40272731905210	1.15439894203513
C	-12.70024224979254	-5.25321148773676	0.02367856662610
C	-11.93988973754450	-6.37651428959307	0.18209388410382

C	-11.41650939311432	-6.72479145668208	1.48181195972146
C	-10.08100193816566	-7.20408417855659	1.65893095072595
C	-9.17199290375964	-7.36719596414339	0.54895382085421
C	-7.86637180843470	-6.98351313421095	0.66464108699904
C	-7.38290535235513	-6.41048913540605	1.89850622695983
C	-6.50856456619391	-5.27869657112035	1.91840103322627
C	-6.42219810384452	-4.51275946574749	3.11809088652778
C	-6.38426741664376	-3.07651767566029	3.02605646576073
C	-6.73994774254500	-2.31815596393409	4.18257984644546
C	-7.51721039422133	-1.14705984994592	4.01766478771325
C	-7.92889305660463	-0.78072163827877	2.69895549573017
C	-9.27183192973466	-0.29501233882726	2.51942336172617
C	-10.11627054561125	-0.20190540525588	3.66903924008605
C	-11.47047748420503	-0.60458998528615	3.54952512173046
C	-11.93149074361763	-1.08316013904296	2.28423738949322
C	-12.80972519938905	-2.22375690919940	2.26688289816089
C	-13.17193034590011	-2.81679879072103	3.51540179795896
C	-13.21759401358840	-4.23133417068291	3.60642340257462
C	-12.89955900302923	-5.00174404079095	2.44584907148347
C	-12.09860441982858	-6.18616154036627	2.61287697495865
C	-11.66482780454504	-6.52894960180498	3.93045458364266
C	-10.34093807939590	-7.00605311762294	4.10630899592639
C	-9.49795762423889	-7.12115742702108	2.95803137041903
C	-8.12172598661138	-6.71658640208400	3.07999675639790

C	-7.67288619355517	-6.22261807998073	4.34361622738511
C	-6.80766354094134	-5.09956985843359	4.36229723754789
C	-6.69995150166290	-4.33441903605526	5.57608665145989
C	-6.66785240351459	-2.92276938458885	5.48287851595349
C	-6.98338143290180	-2.14273158928789	6.64141835165600
C	-7.77011275046246	-0.96081732226539	6.47695384049941
C	-8.21189915372248	-0.61334013426207	5.15911578472078
C	-9.53165576052324	-0.13489702921817	4.98302879834349
C	-10.38163106780628	-0.01632385842663	6.13116679610277
C	-11.74870037105136	-0.42284284785565	6.01021426670482
C	-12.20146916301334	-0.92834783372895	4.74701908949373
C	-13.06352033173111	-2.05093001222822	4.72952570856321
C	-13.45565642014405	-2.64298888091358	5.97493635799177
C	-13.50198015104885	-4.07064866901590	6.06658883061729
C	-13.15397036408766	-4.84105157386405	4.90877501003059
C	-12.36706098270609	-6.00604229156615	5.07317384555939
C	-11.94433891081453	-6.37605935715475	6.39220753859864
C	-10.60831673718444	-6.85756134306425	6.57014863880095
C	-9.75599258450906	-6.94656224744288	5.42040819666334
C	-8.40287077202156	-6.55005828428543	5.54063549742813
C	-7.93277899644752	-6.07033176851599	6.80741960904328
C	-7.06485968889488	-4.93423418658654	6.82478421777560
C	-6.94960368696202	-4.17288433051364	8.02324956582724
C	-6.90219347846545	-2.74491249292118	7.93036454801397

C	-7.24507393875072	-1.97262823047211	9.08873132241633
C	-8.03493619815799	-0.80917116594869	8.92516604519651
C	-8.46135527395159	-0.43743784174687	7.60747301063359
C	-9.79726849341431	0.04341734588898	7.43054003387551
C	-10.64825881772907	0.12850808751394	8.58107073691314
C	-12.00044185169338	-0.27171607416184	8.46147381539781
C	-12.47245611500383	-0.74899976111093	7.19411675108250
C	-13.34513891578022	-1.88315635222748	7.17590189382614
C	-13.70795527120166	-2.48580943260143	8.42539694645831
C	-13.75434393646797	-3.89747482543303	8.51584038992524
C	-13.43647268412392	-4.67677593628369	7.35495277800026
C	-12.64059959782832	-5.85451230073868	7.52140903279848
C	-12.19820161282988	-6.19846483655670	8.84129648272032
C	-10.87649860983876	-6.67287047622608	9.01736893848140
C	-10.02571839495054	-6.79456750411057	7.86978983682398
C	-8.65783678819198	-6.39201147950218	7.99115817484139
C	-8.20394621315771	-5.88346243193740	9.25283650147489
C	-7.33890218204487	-4.76317977650628	9.26949257485739
C	-7.22620806626072	-3.99684135883304	10.48276983936744
C	-7.17797642577541	-2.58188542317416	10.39123746556179
C	-7.49601843691746	-1.81144541553903	11.55138320652667
C	-8.29939952258839	-0.62848273164194	11.38503404397261
C	-8.73556125640938	-0.28644200919457	10.06849160811943
C	-10.06099203469722	0.18783399805958	9.89390698468513

C	-10.90275894131974	0.30103501556066	11.04237013330040
C	-12.27857015702446	-0.10461311382142	10.92105181945096
C	-12.72890555269370	-0.59943336882835	9.65873603599513
C	-13.59578177654800	-1.72193218990136	9.64025902719923
C	-13.98212985538232	-2.30717689546654	10.88484096604771
C	-14.03020235754645	-3.74294304268864	10.97672029281056
C	-13.68823999814079	-4.50623945552712	9.81851092241337
C	-12.89858036356779	-5.67281347307607	9.98364617122701
C	-12.47877054334069	-6.03294829364141	11.30093309018479
C	-11.13363012317905	-6.51321844711967	11.47978231246733
C	-10.29044905253783	-6.60575174434365	10.33051076595541
C	-8.93505206466248	-6.20515291820818	10.44996110585796
C	-8.47202157254637	-5.72669521786984	11.71381375084956
C	-7.59022230010236	-4.58876125494473	11.73074658984408
C	-7.45701574331272	-3.83594723115616	12.93525996165544
C	-7.40834845046315	-2.41063532921315	12.84322358169045
C	-7.69448562438822	-1.55955554619959	13.97443125154427
C	-8.45604396845038	-0.43746459919152	13.81650209442293
C	-8.98194586823190	-0.09134146445999	12.51679309574493
C	-10.31816711498668	0.38463021672730	12.34104280153256
C	-11.22631058259060	0.54784152346620	13.45201803140244
C	-12.53142078018042	0.16328054429433	13.33702854443919
C	-13.01582315811305	-0.41051405113227	12.10340314479274
C	-13.89087407022298	-1.54053159875970	12.08456108997583

C	-14.34613618331025	-2.17761236598790	13.29802466719119
C	-14.39220100820144	-3.53943209156494	13.38510217696197
C	-13.98592466605808	-4.35496654104117	12.26461238828275
C	-13.18911825807493	-5.52984698226813	12.43113379793899
C	-12.74046014732358	-5.97371546935417	13.73011668765351
C	-11.46411111214899	-6.42822397596127	13.89966357193974
C	-10.55118445111909	-6.46999236960959	12.78146823437606
C	-9.18524256112354	-6.06656290370929	12.90163011286543
C	-8.63244887741227	-5.59229514488983	14.14876743857163
C	-7.79598909508881	-4.51329736537882	14.16498337949495
H	-5.86494282807624	-5.23716908272997	-0.18570647216060
H	-5.78020599154145	-2.80651820693998	-0.33829688490608
H	-7.02451033051170	-0.99125718273991	-0.60135846041939
H	-9.30135779680993	-0.17920014151782	-0.90689812534824
H	-11.41924250518832	-0.79595739857308	-1.09410446468190
H	-12.90789624218453	-2.72637668795345	-1.12360951314125
H	-12.97941408267968	-4.93225301771670	-0.98155159276712
H	-11.62196052021715	-6.93726594297426	-0.69877359155415
H	-9.55555077505856	-7.67537595181911	-0.42539999839671
H	-7.22511333874031	-6.99006984069965	-0.21869797056992
H	-7.41205725239419	-1.87940600880116	14.97907766503336
H	-8.77227734005015	0.12474497525429	14.69702064348049
H	-10.84215432958517	0.85743608502053	14.42565873102013
H	-13.17249584216805	0.17067724348767	14.22042778117354

H	-14.53002652715386	-1.57645493928083	14.19033676290001
H	-14.61242267649158	-4.00837571405034	14.34584566789709
H	-13.37738860551366	-5.82508796263101	14.60398495464165
H	-11.09826490830354	-6.63664153124104	14.90670948901816
H	-8.98302028979753	-6.01357897014512	15.09272070257685
H	-7.48938131718070	-4.08646175379307	15.12164452141263
H	-4.31711427581237	0.90773991976040	5.36891632847028
H	-4.81795762490034	-0.55589299624853	3.48981374256813
H	-2.91212267253382	1.02494250557499	3.07938734775419
C	-3.98543795071158	-0.14249329335354	5.41459700789921
H	-4.78936916328351	-0.70270205698503	5.91937462901895
O	-2.99599042069032	-0.05662156268310	7.64550982771329
C	-3.85146341220484	-0.71171724441384	4.00408545124094
C	-2.75222302998691	-0.06212286621909	3.16587544755873
C	-2.72322146559595	-0.25676536924275	6.27478039566413
H	-2.74355466190732	-0.48339133595628	2.14676543693243
H	-3.48073873621396	-0.83747630957943	7.95473020654730
H	-1.76085518052878	-0.23643908761199	3.61143472342917
O	-3.61843215498636	-2.11451057126990	4.15075599522947
H	-3.78178471617549	-2.54745273375064	3.30240522810423
H	-2.25286071010351	-1.24251922654311	6.09421609687738
H	-1.98491413144754	0.50961441349784	5.98797104920486
Zn	-3.85052071050251	-3.45844725648553	6.78157540658596

CNTPVA03Zn

C	-6.99188704415558	-2.64602391199727	-0.42389098316505
C	-7.39823945553663	-1.34243173930382	-0.42043808325959
C	-7.80863990102097	-0.71016568134856	0.81129731777905
C	-8.95574710655336	0.14045670457992	0.88103859300083
C	-9.77289098473645	0.42016813707373	-0.27602781449506
C	-11.13445345123731	0.43209752996423	-0.17123227936395
C	-11.76992846621041	0.16683263134049	1.09774704318565
C	-12.93217736788187	-0.65896658774101	1.20730060953157
C	-13.54248894578074	-1.28035069199308	0.05584626807577
C	-13.97875763552445	-2.57286756625041	0.12020288479928
C	-13.83168615579827	-3.33080817042099	1.34038400190813
C	-13.40541367480868	-4.69558243207055	1.33883085722302
C	-13.09575788036765	-5.39969506221891	0.11683058359930
C	-12.00127034157738	-6.21350800117464	0.04896163073704
C	-11.14351160934629	-6.37728906191864	1.19892831434955
C	-9.71818407741724	-6.39132233272729	1.08676161044891
C	-9.04795579879897	-6.24037557589754	-0.18331663209656
C	-7.93921906970939	-5.45005218242727	-0.28805606451568
C	-7.42593716842161	-4.75745354366194	0.87038091402431
C	-6.96941657710826	-3.40413198691432	0.80494284905060
C	-6.88760602196602	-2.65699073205373	2.01748799513659
C	-7.31492127171730	-1.28179895048822	2.02113159069961
C	-7.64239329534483	-0.67741559001605	3.27380272348839
C	-8.78104074039535	0.16575466895917	3.34325100782372

C	-9.54864218658381	0.37569193125808	2.15676670761924
C	-10.98402570043052	0.38951822794020	2.26697384237417
C	-11.56541195742246	0.19492767451950	3.55744859834572
C	-12.71786866779388	-0.62468300898311	3.66641668277028
C	-13.24735707835452	-1.21976190460393	2.48042623915702
C	-13.70512256889588	-2.58287278194673	2.54844012116658
C	-13.60351011952795	-3.26857907593795	3.79798395393664
C	-13.17954974002197	-4.62198489816401	3.79611997091104
C	-12.87404076413023	-5.24076817203585	2.54499992395627
C	-11.72045715268123	-6.09901267269225	2.47355883779574
C	-10.94406145756359	-6.28799094668323	3.65788577697068
C	-9.53029097477611	-6.30392522442178	3.54654712528395
C	-8.94394806911534	-6.12810514078171	2.25538907607944
C	-7.77479977840095	-5.29512080027975	2.14485994581354
C	-7.26296472637145	-4.68820618817728	3.33243466283183
C	-6.81174835438695	-3.34495938752615	3.26711362371459
C	-6.70732951576069	-2.59311773111280	4.49028106398594
C	-7.12948079090700	-1.24134071821251	4.49490406404755
C	-7.44389798560066	-0.61773043817337	5.74613350664725
C	-8.58715394485063	0.24071670581735	5.81359292730905
C	-9.37059187010400	0.42508228964096	4.62986456879543
C	-10.78198188544329	0.44312883710168	4.73846951878798
C	-11.38040113995967	0.27374071941782	6.02961692233898
C	-12.54130804509064	-0.55523845142200	6.14089135603935

C	-13.05357904368612	-1.17451348904067	4.95364883697140
C	-13.50153061065476	-2.51573829227073	5.02060497356020
C	-13.42630885880028	-3.20924535322697	6.27304026842022
C	-12.99709178473021	-4.57476905344467	6.27104703790444
C	-12.66408497488722	-5.18432395389523	5.01675350301601
C	-11.53127008495923	-6.03025357935203	4.94669468839102
C	-10.75616706836497	-6.24928881472594	6.13260118190191
C	-9.32923048439159	-6.26778322250853	6.02041687105083
C	-8.74355410584914	-6.06374065732767	4.72754328471659
C	-7.59370983128147	-5.24538181841456	4.61838757462742
C	-7.05483311995039	-4.65020781265720	5.80515451913629
C	-6.60432274599412	-3.29212727823521	5.73902255126570
C	-6.51159545900906	-2.54441634373828	6.95038444133523
C	-6.94133885611011	-1.18070532961224	6.95309531265594
C	-7.27382283213143	-0.57252980913413	8.20369004716532
C	-8.39745280271390	0.28023788051585	8.27074977727748
C	-9.17553933151799	0.49083409193519	7.08643785255532
C	-10.59842799600094	0.51380921687904	7.19737197629655
C	-11.18490365213979	0.31528794221098	8.49104251574878
C	-12.33303348438369	-0.50395788337335	8.60100468533882
C	-12.87163900580444	-1.10422577942111	7.41464045686894
C	-13.32203854170419	-2.46053332003532	7.48189984705559
C	-13.21427731859250	-3.15490717285428	8.73202464725606
C	-12.79133913350286	-4.50547284965117	8.72983444833814

C	-12.48423700883083	-5.13356640814160	7.47787965441947
C	-11.33924684662190	-5.98923911149160	7.40719119614957
C	-10.55394233452817	-6.17840347210959	8.59204605308679
C	-9.14313885541605	-6.19883154934406	8.48158660850784
C	-8.54787980896954	-6.02788836144002	7.18819867489199
C	-7.38565835572656	-5.20032049971323	7.07774602536169
C	-6.87331672448765	-4.58230169609498	8.26638098461795
C	-6.42995818758042	-3.24058633508797	8.20118420133538
C	-6.33132499188765	-2.48610839197560	9.42290590825157
C	-6.76062968826228	-1.13489313217004	9.42255039542741
C	-7.06254809186090	-0.51479428094608	10.67187389608153
C	-8.20584496673397	0.35436873965317	10.74171640619427
C	-8.98264376858464	0.54350737709543	9.55817320327874
C	-10.39673126710087	0.56019016968466	9.67058594083676
C	-10.98113546853658	0.38649126611327	10.96288041329228
C	-12.14828883670204	-0.44873702808705	11.07504061187995
C	-12.66110664275694	-1.05790585377039	9.88837658354416
C	-13.10837320818483	-2.40229856331121	9.95477182289419
C	-13.02894483835559	-3.08801456696633	11.20563259379818
C	-12.59911640871279	-4.46191034076680	11.20324667110741
C	-12.27399537712651	-5.06661933309749	9.95023863248507
C	-11.13988030552161	-5.91564486960666	9.88046729081631
C	-10.37211775540809	-6.12889385004906	11.06634527510322
C	-8.93695510884650	-6.14736306339472	10.95435223594660

C	-8.35735379843992	-5.95317817491216	9.66294547088240
C	-7.20489970818950	-5.13365164290769	9.55399531290747
C	-6.67542130042944	-4.53648156096759	10.73954436949366
C	-6.22228399893704	-3.17157732089016	10.67187860438907
C	-6.09811867289617	-2.42108818317294	11.87849658766146
C	-6.52643395773896	-1.05642353551563	11.87669878241657
C	-6.82786182357119	-0.34491282895514	13.09712445810518
C	-7.91899325958204	0.47415856157022	13.16446417426957
C	-8.77978185213493	0.63753834592691	12.01602856330434
C	-10.20528691916118	0.65258219495302	12.13039209319266
C	-10.87373949382960	0.50184965808398	13.40129233035217
C	-11.98086140289464	-0.29073410180456	13.50788474006776
C	-12.49403176069266	-0.98567612864974	12.35076665581775
C	-12.94707706538495	-2.33997136500536	12.41766818329515
C	-12.92090584023303	-3.09744836560303	13.64674554011908
C	-12.51459414155518	-4.40112009085946	13.64478089472584
C	-12.10553730985355	-5.03450342142242	12.41312252107333
C	-10.96271371961470	-5.89018804082943	12.34273831596223
C	-10.14509587786084	-6.17301627353150	13.49902111557797
C	-8.78389449840191	-6.19003415962679	13.39296256217872
C	-8.14929283270361	-5.92487560604787	12.12310221334209
C	-6.98870547909010	-5.09739000242027	12.01310429790874
C	-6.38086226505768	-4.47214967782866	13.16441772939774
C	-5.94969241046686	-3.17785559646956	13.09947871522920

H	-6.80972344901043	-3.14872717662359	-1.37547946139257
H	-7.53502821190206	-0.82094542721818	-1.36954145316287
H	-9.31023709123714	0.49346757917392	-1.26191140358760
H	-11.74102102555735	0.51466707120338	-1.07496769685894
H	-13.53880140272232	-0.76318244402832	-0.90542356895362
H	-14.31738709167026	-3.07044646875708	-0.79038084840809
H	-13.65911602088338	-5.18218677496589	-0.79244941066176
H	-11.70526938333133	-6.63488902681760	-0.91346527591755
H	-9.50031870888899	-6.65152711063187	-1.08762216356059
H	-7.52140970104908	-5.24086271969369	-1.27450350067112
H	-6.26185553177962	-0.55979150023912	14.00539461568273
H	-8.20965920039437	0.90155979391609	14.12597694782299
H	-10.42095675318210	0.91430575193830	14.30489594914979
H	-12.39708444777750	-0.50008857492183	14.49500107799625
H	-13.10153601471250	-2.59371294108369	14.59814555910661
H	-12.37620805332095	-4.92128564911089	14.59437683436868
H	-10.60714698231251	-6.24487021166013	14.48535105418059
H	-8.17630005573593	-6.27510969919943	14.29577453892808
H	-6.38379306523126	-4.98821540933557	14.12627554560978
H	-5.61476008161932	-2.67842301756890	14.01047832075592
O	-3.69528912417240	-1.59198976707779	6.05786396491246
H	-4.19302471166062	3.10118159617815	9.14600193838623
H	-4.33069818380551	-2.31994101140442	5.99749732283224
H	-3.69031562271635	2.63449459674729	11.54405381800186

H	-2.84062022998548	1.85253967644304	7.56180199839362
H	-2.89865188673377	1.01064390096893	9.87056743324883
H	-1.81954602030068	-0.05118122641907	6.61389828569374
C	-4.69575694863131	2.43646228660759	11.13865890990185
H	-5.33261757793400	3.30272910982007	11.38455759149651
C	-4.65060021115112	2.21199777305066	9.62861997066605
C	-3.37699315185904	0.90879352305207	7.78830684198765
C	-3.81377468518654	0.98746705365035	9.25544969808471
C	-3.07261382047302	-1.60697281446855	7.34288246517159
C	-2.39907916094245	-0.25225354800089	7.53057140122967
H	-2.31986526240998	-2.41510703782525	7.39517770966540
H	-6.49180284236641	2.81340240571571	9.30247211150818
O	-5.96584246698464	2.02281574004357	9.11946895423032
H	-4.39191503563217	0.06512062672733	6.32413302045528
H	-5.11450582708357	1.55435117430896	11.64712429909877
O	-4.50687417689192	0.82372976674265	6.92925592110504
H	-3.81805418046102	-1.79325938011359	8.13704233522860
H	-4.37344927325008	0.08114756357448	9.53732678706960
H	-1.67480147778559	-0.30976389998259	8.35898165660804
Zn	-6.30014197104475	2.49442028473486	6.43389914011486

fCNTPVA01Zn

C	-6.84793493843193	-2.69108946235895	0.03417845521279
C	-7.22313051522084	-1.37737013187802	0.07880866414049
C	-7.68502677168994	-0.79382074837449	1.31418320664606
C	-8.79264097303367	0.11397146752646	1.36015101169929
C	-9.50313885899952	0.51800527817858	0.16800663977829
C	-10.86288572356027	0.62862468288345	0.17805299892742
C	-11.60665808500819	0.34121326391724	1.38266579970027
C	-12.81834460675689	-0.41278026839598	1.36205165203076
C	-13.36373835716900	-0.96844227745285	0.14416787482766
C	-13.85098262770741	-2.24355948462841	0.13388698233487
C	-13.81409908692982	-3.05061981035260	1.33382793261207
C	-13.41611034783757	-4.42250281497772	1.30781186454892
C	-13.06270088455899	-5.09645220468107	0.08212355993600
C	-12.00620314820417	-5.96183032898170	0.04487951944887
C	-11.22858752802408	-6.21539058973868	1.23292436277009
C	-9.80305305212456	-6.33638348738687	1.20161441622039
C	-9.04932198064719	-6.17947682841786	-0.01889112181131
C	-7.88854032623132	-5.45896428617504	-0.02269941315306
C	-7.40970577612556	-4.84824411265703	1.19434535838598
C	-6.90577307131112	-3.50778669791672	1.22136240240875
C	-6.87843716670189	-2.82422364674427	2.47175912364535
C	-7.28510538286319	-1.44367958290272	2.51769005946833
C	-7.67956079503369	-0.90059735105809	3.77922116552113
C	-8.79468530766839	-0.02718400168116	3.82161439710496

C	-9.45781569998669	0.31105698456355	2.60235709288213
C	-10.89529833785049	0.44529456639972	2.61850724525045
C	-11.58717754236618	0.23963787020955	3.84818078445481
C	-12.82629968759244	-0.45684824291896	3.82231924229410
C	-13.27015773188308	-0.99715169806839	2.58126175956108
C	-13.7636553946494	-2.34933927454974	2.57455646017770
C	-13.72652485210313	-3.06890594359910	3.80854923093040
C	-13.30880797754466	-4.42283636989174	3.77777913369797
C	-12.96468240436167	-5.01732128070937	2.52435976290704
C	-11.85708505462489	-5.93721251222459	2.48319518619296
C	-11.16542293384639	-6.22801021165866	3.69854089267810
C	-9.75397318681291	-6.36418348926369	3.66931228771723
C	-9.08169456854158	-6.18179799462250	2.42231867548589
C	-7.85658698993259	-5.42512128417507	2.41880593071169
C	-7.38418594543470	-4.90159094505982	3.66345615964592
C	-6.88675545800616	-3.57403270196517	3.68957965305313
C	-6.83461410357763	-2.88720150333846	4.95320957757368
C	-7.24158410568014	-1.53048640673692	4.99655058970542
C	-7.62311784526551	-0.96674678022192	6.25364917861944
C	-8.76541125889176	-0.10315998569111	6.29401694680380
C	-9.45990160233644	0.17429376640679	5.08193157596230
C	-10.87095924763629	0.29241790750881	5.10919621292235
C	-11.57040219052276	0.12875846703978	6.33903509253700
C	-13.01231164068328	-0.25488553664062	6.31139484530312

C	-13.31015687321765	-1.00921981715669	5.06463325092891
C	-13.69441952847781	-2.34599234019314	5.06150109680612
C	-13.63847421479951	-3.08910976037580	6.31312220642777
C	-13.22524561689680	-4.45623087609110	6.26097530118530
C	-12.86375839749507	-5.03836746169332	5.00203348966825
C	-11.80246588490436	-5.96673971052560	4.96024043895499
C	-11.11928639960945	-6.30339323622972	6.17775850267394
C	-9.69835218264393	-6.44752127034604	6.14913825466195
C	-9.02170927046172	-6.23715244859510	4.90310011381434
C	-7.81373683268130	-5.49881189509416	4.90091730034272
C	-7.31941931113490	-4.98326455271320	6.14578997019987
C	-6.81664327127736	-3.64330162231268	6.17052667866171
C	-6.77870543753745	-2.95368247110376	7.42031494933294
C	-7.19680968698783	-1.58869949888974	7.45902274528603
C	-7.61748335021157	-1.03562732332511	8.71611267591245
C	-8.74075829269945	-0.18361254407596	8.75175872565909
C	-9.43687488091020	0.10053894731062	7.53181935460227
C	-10.85801497652553	0.22551043404359	7.54698124923912
C	-11.55620846010027	0.05121183592268	8.81223804245459
C	-12.81748761760347	-0.52186278942201	8.85447996192238
C	-13.62036669381540	-0.89522402854444	7.60201858686361
C	-13.66905729905586	-2.42867098975479	7.54605822457992
C	-13.60424625587096	-3.16731830686052	8.75009564097540
C	-13.19118076993776	-4.52315645491894	8.71481057585295

C	-12.82863265686811	-5.10100991328777	7.46371095982460
C	-11.75719182140909	-6.05250647898358	7.42285758612622
C	-11.07374073077678	-6.35427905127176	8.64109866322941
C	-9.66437838199536	-6.49564256485437	8.61755020317703
C	-8.97522576113698	-6.31906003681637	7.37352203363733
C	-7.75604158098431	-5.56943549041564	7.37151606660181
C	-7.29301442740210	-5.02873331706878	8.61841586545317
C	-6.79681628560389	-3.70323255953925	8.64257067347767
C	-6.76512669675197	-3.00604072236334	9.90246680240075
C	-7.17984395050209	-1.65028213587327	9.93943180141694
C	-7.55666272552746	-1.07766012581115	11.19187121255496
C	-8.68615306400894	-0.18580214496739	11.22817510320486
C	-9.39075849492335	0.06509410612067	10.01090179563853
C	-10.80077466475984	0.19108428122488	10.04391086897819
C	-11.46368885519498	0.06515312916868	11.30139908165713
C	-12.70587217696432	-0.66062873228672	11.32484752658106
C	-13.21676921578656	-1.14970594800913	10.08929689351256
C	-13.65276548970967	-2.50073589652587	10.03999625367372
C	-13.64782253577106	-3.26260004556201	11.23981296964653
C	-13.21738469022923	-4.64168890951138	11.19246406952437
C	-12.80336259269982	-5.17730417628406	9.93523217551842
C	-11.72508282663597	-6.09593489693935	9.89809464126659
C	-11.06137937625481	-6.42164891357858	11.11984018568407
C	-9.62771197776829	-6.55247024412430	11.09855452250201

C	-8.94668195420237	-6.35554550941994	9.85652468945880
C	-7.73844723527557	-5.61336544904236	9.85668432420798
C	-7.26182911765352	-5.09440366502625	11.10129184682993
C	-6.75946706681625	-3.74535311642396	11.12451778873112
C	-6.70247235997815	-3.05110841733721	12.36994802582407
C	-7.10670688375888	-1.67963749707314	12.40418635303819
C	-7.46980753801906	-1.01503395755618	13.63184461190727
C	-8.53066374828665	-0.15543677363526	13.66807875827661
C	-9.31264768193654	0.09284699175250	12.48001558857092
C	-10.73380312747769	0.22222300152606	12.51784159599254
C	-11.47944629500444	0.07058828036856	13.74857969238073
C	-12.63433665173784	-0.65544721557838	13.76637047815589
C	-13.12848135754086	-1.26078273240596	12.54881621898364
C	-13.63138527009990	-2.59253524567796	12.50482228854133
C	-13.70419981165068	-3.42152117757893	13.68678726263751
C	-13.32168701948530	-4.72937746098861	13.63431534794132
C	-12.83389380514273	-5.29636459442011	12.39615167987259
C	-11.72455746626757	-6.20169084525271	12.36191919409692
C	-11.00789445165810	-6.58195198981636	13.55446926486753
C	-9.64607561045054	-6.69700235135629	13.53645079725393
C	-8.90859226594146	-6.43723354243560	12.32402268920107
C	-7.68800795056480	-5.68886655694716	12.32477347339210
C	-7.13087222863388	-5.14287882396972	13.53950923861934
C	-6.65133131103621	-3.86416697827929	13.56174696193838

H	-6.63332537661216	-3.15292957670508	-0.93132456047503
H	-7.29795936538080	-0.81088107787171	-0.85101588382061
H	-8.96378180842879	0.61976427121120	-0.77545257140896
H	-11.39664844649011	0.81376449431622	-0.75586417180336
H	-13.26830825581232	-0.42005151874835	-0.79476372478254
H	-14.14080707999273	-2.69764136926992	-0.81546237073553
H	-13.56145784377529	-4.82199580907834	-0.84923756941128
H	-11.67581701969668	-6.36291114994349	-0.91499483736001
H	-9.47198128471794	-6.51899371858475	-0.96635584991827
H	-7.40127200988208	-5.23177473273205	-0.97270716705893
H	-6.97285498958303	-1.29043591745777	14.56395948615402
H	-8.86293828567789	0.24409021269674	14.62770286780975
H	-11.05012816734895	0.41874483976422	14.68975443124378
H	-13.11335718025985	-0.88380966701680	14.72044282754750
H	-13.94861388336325	-2.96966705183588	14.65022685113453
H	-13.27134067133817	-5.31295629377637	14.55522553616383
H	-11.53696680606950	-6.65312882310104	14.50640232276875
H	-9.10972280643985	-6.85292452923202	14.47422770736397
H	-7.21528946625426	-5.70027764068360	14.47431658869188
H	-6.35939227151021	-3.41671291968574	14.51362031796602
C	-15.05750257432816	-0.38700119972022	7.84368523549846
O	-15.99478888426084	-1.02290561134845	8.22399174954800
O	-15.17540912769031	0.96854824103258	7.60620385538553
H	-16.09042714298082	1.23196060303754	7.81111655234505

H	-14.24241276005214	4.64095166533338	3.45334496696788
H	-14.93275681336266	3.98216711572342	5.64127621004607
C	-13.92672563580878	3.67526039155682	3.87132292555183
C	-14.30198652959871	3.26788345554343	5.09852832578267
O	-13.15347689439772	3.02908896607286	2.97472095184684
H	-12.83809512552925	2.18773138828068	3.34572564860442
Zn	-13.85710358342628	1.58377358076505	5.92770945586387

ffCNTPVA01Zn

C	-6.59388384029245	-3.16746585374528	0.00787861522296
C	-6.92151960148576	-1.83877201711982	0.00087876075530
C	-7.38985181153088	-1.19618521906566	1.20266117324134
C	-8.45476098396106	-0.25357004532256	1.20066652047159
C	-9.13804301798238	0.13482879457393	-0.01145362700120
C	-10.48338696821776	0.34263814415380	-0.01099290848781
C	-11.26473698773764	0.19714904483099	1.20519756735610
C	-12.57632600818778	-0.24671624981048	1.19095400909435
C	-13.19925609380814	-0.77660698058219	-0.01371480381432
C	-13.75118260518352	-2.01687137211166	0.02860293398112
C	-13.65187185747069	-2.80272889555972	1.26408944202901
C	-13.26800631306454	-4.19761067558306	1.24250767725425
C	-12.91906828088042	-4.86877335085931	0.03112231827880
C	-11.94497234715778	-5.84170778922127	0.01959867112907
C	-11.25522237958308	-6.19863521870588	1.21950207980009

C	-9.84049065702243	-6.48907819637308	1.22335497953588
C	-9.05431910697460	-6.45370226183487	0.02255432175504
C	-7.82466615612891	-5.84747613128582	0.02202618110416
C	-7.31833049645008	-5.24406468308013	1.22353020530213
C	-6.72376614359520	-3.93727135056367	1.21768652068151
C	-6.69432299961278	-3.20978678452351	2.44406005134940
C	-7.02236045648228	-1.81799301762341	2.43904624517562
C	-7.39369873451058	-1.20108982398899	3.67273309591786
C	-8.45672838579091	-0.25388012366549	3.67356773785494
C	-9.12787664301846	0.03356638027626	2.43596828380578
C	-10.52072858638360	0.30085468099236	2.44539072114763
C	-11.22583890199054	0.23156093097278	3.68741498352809
C	-12.56055986747438	-0.23554523480443	3.72194631840492
C	-13.33773855643391	-0.59687207482455	2.46076458680192
C	-13.59347364220265	-2.11604613166314	2.47210086042896
C	-13.56616301303776	-2.81655552910904	3.71473161703292
C	-13.21650618864498	-4.19942957345647	3.70766916031985
C	-12.88044922570198	-4.81791929749466	2.46398389094571
C	-11.86954424287120	-5.83607412318007	2.45336835542703
C	-11.24177637112150	-6.18830390101945	3.69167024017277
C	-9.84478707271201	-6.45886306345042	3.69436195875622
C	-9.13330913273572	-6.36847704863910	2.45250407972608
C	-7.84495981292692	-5.73591726273004	2.45419865611720
C	-7.35472232851041	-5.21310035891108	3.69325767826039

C	-6.76165321894669	-3.91952615454050	3.68856592845705
C	-6.68153502256448	-3.19892636730677	4.91878579413835
C	-7.01026754575581	-1.80576589444133	4.91114011949483
C	-7.36849068586502	-1.17658274180410	6.14270264890878
C	-8.42658968791698	-0.21969627551215	6.14308839192231
C	-9.08851355723640	0.06715993098948	4.91103122237545
C	-10.49828906238210	0.29490949598556	4.92228561479680
C	-11.20719960600238	0.24968469369830	6.16854770019363
C	-12.53219719219387	-0.24201267627964	6.16433361713389
C	-13.04828643629580	-0.74107795323932	4.94652192492910
C	-13.57702815344989	-2.10483465288982	4.94758195470764
C	-13.55744096080332	-2.82170961388806	6.17771046877659
C	-13.22297703578946	-4.21484793770816	6.16646220565861
C	-12.88191436219521	-4.84242377845969	4.93434963980613
C	-11.87777812397033	-5.86024814110489	4.92897955202248
C	-11.24980689770331	-6.21566219128798	6.16159581216672
C	-9.84440535044016	-6.47617276019329	6.16350428805238
C	-9.13077772328993	-6.37880245760112	4.92965255981648
C	-7.85495640684819	-5.72920584344210	4.93056903788356
C	-7.35375425918769	-5.20752007589601	6.16262879273865
C	-6.75295109699113	-3.90996694625617	6.15554984882339
C	-6.68121462394565	-3.18256277799981	7.38581677197487
C	-6.98348014175546	-1.78738115506439	7.37748389778255
C	-7.34990550046070	-1.15770721617168	8.60580963947037

C	-8.39944953238272	-0.19812471300262	8.60825749069688
C	-9.07893552255981	0.09915998980993	7.38073981106595
C	-10.47221776218476	0.36178553681178	7.39552124034966
C	-11.18231724180341	0.23746707200971	8.64359302979084
C	-12.48271290933230	-0.27324021144972	8.68503281443792
C	-13.28361741843534	-0.61618444034290	7.44116262846496
C	-13.54461170521767	-2.12784810998790	7.42258938919245
C	-13.56460930642274	-2.83188041788928	8.62660299822470
C	-13.24090593948103	-4.23313945364363	8.62616705040942
C	-12.89341707633978	-4.85822386165160	7.39630938807569
C	-11.88947336451932	-5.88065367707145	7.39530878399319
C	-11.26009890848210	-6.21597127857243	8.62680328923639
C	-9.85072623443246	-6.45922634787992	8.63137185224758
C	-9.13248802395660	-6.37028661746816	7.40070079500379
C	-7.85685769887673	-5.72124595649321	7.40068547363208
C	-7.36529874608769	-5.18855733671564	8.63010496288090
C	-6.76409012108821	-3.89245260354321	8.62234582986725
C	-6.69155726176657	-3.16574775943490	9.85450289615124
C	-6.98389716753091	-1.77703988583108	9.84626594594288
C	-7.30978409614904	-1.13676931321025	11.08519944048871
C	-8.35632410321636	-0.15086444538840	11.08871196320145
C	-9.03113907465217	0.12512853499173	9.85361674513468
C	-10.43044922832884	0.34007149593880	9.87437826660696
C	-11.11006553216858	0.26989049820920	11.13052291597728

C	-12.39619980366039	-0.36750726968357	11.15426701072185
C	-12.93695185068045	-0.83696015303555	9.91572408696577
C	-13.53002135444975	-2.13025018923248	9.89941588662459
C	-13.60233372980592	-2.85978022120234	11.11866115517106
C	-13.29778324949011	-4.27358289606978	11.10692333434753
C	-12.90951633323885	-4.87200645943700	9.85896448951957
C	-11.89915495995859	-5.86967572450893	9.85981913627574
C	-11.27689323655049	-6.21053429888242	11.10403801882480
C	-9.85801920898090	-6.44061590002844	11.11100705777582
C	-9.14581740130578	-6.33253201326898	9.87099538119108
C	-7.88314807351426	-5.68397176080737	9.87027675351607
C	-7.38412486597531	-5.16527591758758	11.11037809460220
C	-6.76294024057210	-3.86866719032710	11.10168735737852
C	-6.63704774772038	-3.15216061855602	12.32281777933454
C	-6.91008070626393	-1.73439792813959	12.31343582830104
C	-7.21776297911591	-1.01094585846444	13.51387304559989
C	-8.21360902896784	-0.06824207424814	13.51781373510435
C	-8.96279279185406	0.20872475423796	12.32415715638953
C	-10.38668600150020	0.42099236225773	12.34851944638959
C	-11.14458586426902	0.33770589366073	13.56656248971899
C	-12.35757701157726	-0.30119264651170	13.58532736684758
C	-12.89272825902233	-0.88067583372167	12.38342307164265
C	-13.53286350867258	-2.16853785749079	12.36675134520821
C	-13.68728821197324	-2.95504860059994	13.55947572209331

C	-13.43884102390060	-4.30130905632871	13.54006621055066
C	-13.00151099144579	-4.93480284474480	12.32314136849164
C	-11.94485930983253	-5.92487180560596	12.32568083166217
C	-11.27519656328586	-6.31222993368438	13.53148096513071
C	-9.91649653751147	-6.51852914631749	13.53923255945953
C	-9.14908486059972	-6.35905642425028	12.34048481008963
C	-7.86438093145246	-5.69393859621952	12.33988008697236
C	-7.28724515213944	-5.16055800152239	13.53964981163398
C	-6.69120609123861	-3.92401064230210	13.53093702285958
H	-6.37859904318170	-3.67012907792068	-0.93687897649704
H	-6.95610644435955	-1.30393875896222	-0.94996630321084
H	-8.59296770635476	0.15520700192880	-0.95716595261064
H	-10.99853992386556	0.52773884843943	-0.95542663887213
H	-13.13609831166715	-0.23703987854285	-0.96293779001647
H	-14.16886250988845	-2.47133469215004	-0.87161626489067
H	-13.32466790685291	-4.51653648684212	-0.91823490515510
H	-11.60109144123008	-6.23069075948961	-0.94014147037547
H	-9.49324535410800	-6.76778062375072	-0.92608016299740
H	-7.30942442005944	-5.68903702195168	-0.92716622856900
H	-6.76122162774707	-1.30658184200884	14.46017860662617
H	-8.52622812569446	0.36892158136067	14.46775391154103
H	-10.69341749736983	0.64765531340525	14.51079582221974
H	-12.84590951253996	-0.48822308017768	14.54357422529156
H	-13.87269896067989	-2.46012002937585	14.51495331538330

H	-13.43908330054055	-4.86017917631630	14.47723441545275
H	-11.81217380755244	-6.29652151270273	14.48108709962762
H	-9.40898412072185	-6.65831466556492	14.49537554999448
H	-7.45559152903180	-5.66147771754251	14.49457904860847
H	-6.39708852354809	-3.47165149440992	14.47970210851626
C	-14.58865613593561	0.21301903541449	7.39326715207410
O	-14.64753575513237	1.35384418169605	7.81303754298319
O	-15.56378708091438	-0.41974265919754	6.76734382566292
H	-16.27766252239937	0.21282079674431	6.48941271657985
C	-14.68174583214540	0.17414562943348	2.55323831204886
O	-15.65029693853526	-0.21582465663268	3.15454205933649
O	-14.62057061725913	1.36804948299004	1.94543747643384
H	-15.46390163250076	1.82126402904401	2.12061062161307
C	-17.01959044880937	1.82589291773478	5.54898038992961
C	-17.63629977146493	2.16891465712203	6.70025743101739
O	-17.06688078827291	2.56392310598504	7.83943393604946
H	-15.94401540828435	1.96572047094418	5.40568113764659
H	-18.73004921287791	2.11897606805458	6.78376261170816
H	-16.10453800668912	2.34297496720330	7.82565132551693
H	-17.60137500322764	1.48522559319102	4.69181204153551
Zn	-13.20166445174247	2.51476976179905	4.95488200143257

fCNTPVA02Zn

C	-6.82326263286333	-4.40478557142642	0.09832937264614
C	-6.58526479470920	-3.05870730556681	0.02064651932872
C	-6.82127212072817	-2.21242288337362	1.16140891007230
C	-7.42017708079520	-0.92467783724256	1.04912254132898
C	-7.83304833841932	-0.37855927932455	-0.22173502564389
C	-8.98617008663501	0.33892657504524	-0.32557822959723
C	-9.81934313475575	0.57826681573701	0.83776264801152
C	-11.20091245990384	0.66144692402470	0.74929684790806
C	-11.91952646781271	0.35603074908105	-0.48415862056358
C	-12.88586342107901	-0.59511970952776	-0.45095903258141
C	-13.17007276720392	-1.30015795519336	0.80570208172587
C	-13.40987040885942	-2.71868783208046	0.84785056414672
C	-13.29780904651977	-3.54852665798949	-0.31421559704182
C	-12.79932244715957	-4.82484489014543	-0.21515147119093
C	-12.37196722482921	-5.34663920577407	1.04978294336077
C	-11.18138393051917	-6.15270804959964	1.17294383687263
C	-10.37080547106914	-6.48788393342594	0.03628381321246
C	-9.00482166147935	-6.39494873028261	0.10946212830391
C	-8.37800620696489	-5.95174259292734	1.32385895035713
C	-7.31491695788227	-4.98562377410349	1.31942658473620
C	-7.06834251687259	-4.25663380878469	2.51991613571363
C	-6.81020533890076	-2.85134537815372	2.44341895169543
C	-6.95188872905523	-2.06330621188430	3.62725162615604
C	-7.53611445192119	-0.76754909215538	3.51766990907415

C	-7.97889859604340	-0.32069573669981	2.22435954897193
C	-9.16767665195157	0.45258508162702	2.12724780273902
C	-9.89870090186326	0.74592537241729	3.32343006635012
C	-11.31390037736666	0.77587667222542	3.28391558398416
C	-12.09445869220324	0.67225811428332	1.97996114969355
C	-12.91757671258525	-0.62612583491928	1.99947196903224
C	-13.27152968046241	-1.20100537991387	3.24713965441066
C	-13.53145221575283	-2.59675337353354	3.30839234469275
C	-13.39488568826081	-3.37090128144755	2.11480192931945
C	-12.87477878440991	-4.70552113211876	2.21758872416284
C	-12.50676961198792	-5.19052659027032	3.51517079554842
C	-11.31816338298196	-5.96271033339358	3.63470878288742
C	-10.55439006711181	-6.22472659394593	2.44884597938680
C	-9.12475250817879	-6.12279512549898	2.52738648034507
C	-8.54305153758109	-5.75408662750670	3.78296894991026
C	-7.48617542870836	-4.79976699631668	3.78015095250529
C	-7.19251417108907	-4.09592586850678	4.98636781704117
C	-6.90965238147316	-2.69428612335980	4.90955446157473
C	-7.04137714285465	-1.90053775709686	6.08924888506859
C	-7.60552847290083	-0.59340796186528	5.98052996151879
C	-8.03444334236796	-0.13523167974884	4.69144937422756
C	-9.23815912719225	0.63173258017546	4.59305427608744
C	-9.97115984247302	0.89345189409153	5.78790792564738
C	-11.38810938458866	0.80189170099180	5.73247581643037

C	-12.01804680723018	0.52729964802251	4.47842124470439
C	-13.06947147204868	-0.47808173183423	4.46826367102140
C	-13.45687255193650	-1.06218907699333	5.69548988521067
C	-13.73341158281002	-2.46736382373956	5.75758251690376
C	-13.57159858733262	-3.24756537417214	4.58131308403955
C	-13.04833619610125	-4.57367416977143	4.68626993247478
C	-12.67271785403469	-5.05681446826136	5.97510612080880
C	-11.46878974565555	-5.81985217209063	6.09386109414204
C	-10.69929443296094	-6.07358002112347	4.91801136282728
C	-9.27268588310577	-5.96422830156314	4.99421420625444
C	-8.68330611799938	-5.59342950916972	6.23988578140910
C	-7.61724143353913	-4.64090443640153	6.23725051676627
C	-7.32104204582867	-3.93767159439638	7.44762031564431
C	-7.01934341538148	-2.53860839618503	7.37389576189581
C	-7.14373318478863	-1.74922887344658	8.55243237893767
C	-7.70016572922166	-0.43163638836493	8.44537600370894
C	-8.11322175609822	0.03634433432431	7.16229004194189
C	-9.32470530832317	0.79355835269142	7.06577864360317
C	-10.07969253605462	1.03167373555723	8.24758327975948
C	-11.51003234714583	0.91625461464252	8.18560184748837
C	-12.11361546843534	0.57894497852572	6.94254563197729
C	-13.18601662334231	-0.36963356595186	6.92793723783641
C	-13.62030255136326	-0.92559335724883	8.15939363415021
C	-13.92276385247582	-2.33368526930613	8.21756330906521

C	-13.75976080554018	-3.11344377906379	7.03407407053419
C	-13.21205642909952	-4.43146005954127	7.14499282486407
C	-12.82766681306481	-4.90716810826935	8.43344602500864
C	-11.61233913389174	-5.66051969297793	8.55215634662630
C	-10.84341672291938	-5.91181582940897	7.37836539936306
C	-9.41780120841046	-5.79444969469392	7.45344295251699
C	-8.82786194372953	-5.42684146608947	8.69658817330120
C	-7.75066898781743	-4.47962521843570	8.69431979482327
C	-7.46485885532278	-3.77397339213759	9.90331394853207
C	-7.15127894171380	-2.39038559993697	9.83228611927962
C	-7.26359527538928	-1.60334364161550	11.02661928182366
C	-7.82300254316335	-0.28337950526977	10.92004294853914
C	-8.23711412145635	0.17620040781175	9.62371823712937
C	-9.44720547836235	0.91321974751910	9.52463675717515
C	-10.20465871146940	1.15006423027251	10.72081834420241
C	-11.63574481063740	1.02641430058660	10.65559765188333
C	-12.22864822373713	0.67891144367684	9.39504587056654
C	-13.30237203042737	-0.25196578508962	9.38276909326071
C	-13.74395077087990	-0.79663896160168	10.63441880419692
C	-14.06623698760981	-2.19688134958982	10.68989873876518
C	-13.91661275587223	-2.97616443883390	9.49020313763783
C	-13.36080804998975	-4.28230465475969	9.60098356422682
C	-12.97626017419264	-4.75414323993135	10.90137174236648
C	-11.74940650715480	-5.49280923333511	11.02034005887053

C	-10.98121887424028	-5.72984850208768	9.83209986625680
C	-9.56697259630656	-5.61146602928522	9.90601049486171
C	-8.97703720259346	-5.25671357462079	11.16452361451361
C	-7.89136065259227	-4.31454070643472	11.16358203767334
C	-7.55007917126449	-3.64683007213888	12.36994238393621
C	-7.21733421836337	-2.23736520707466	12.29840363833923
C	-7.28934796412631	-1.38523589306465	13.44577467166963
C	-7.82476498449720	-0.12290266376033	13.34363301042688
C	-8.31782994587311	0.35641322922105	12.08826073820571
C	-9.56086785404147	1.09671190769890	11.98628675240308
C	-10.37005512689512	1.37671951390211	13.13303268477724
C	-11.73894805768770	1.25670776129935	13.06930197757772
C	-12.37593673965380	0.85002387873416	11.85391176446907
C	-13.47740441949604	-0.09531545726081	11.84224711678304
C	-13.99229352928099	-0.67085965490467	13.04575298439894
C	-14.30953179408360	-2.00838598726650	13.09819417583400
C	-14.12246431453203	-2.84423709221982	11.95197074187891
C	-13.55476478487417	-4.17642242152552	12.06362808476293
C	-13.15155126815676	-4.72036532466437	13.32250154165538
C	-11.97247376292375	-5.42193546749781	13.43637417332075
C	-11.13374753271867	-5.61982318550509	12.29576887401695
C	-9.69017667731599	-5.49508615741396	12.37070869700369
C	-9.02143691133064	-5.15842906040305	13.58998161862772
C	-7.97890103782415	-4.26114269718887	13.58979093735774

H	-6.77739654292796	-5.00777798512777	-0.81049481351423
H	-6.35110340855898	-2.61328325139274	-0.94781638385075
H	-7.27883504947608	-0.63618165416713	-1.12618117158196
H	-9.34250064666455	0.64800807909219	-1.30966135869308
H	-11.61489411817250	0.79863956827356	-1.43640741356992
H	-13.39628581002097	-0.89855697475147	-1.36710874095267
H	-13.47725858672406	-3.12415268834159	-1.30335420700215
H	-12.59028181520939	-5.38271608064095	-1.12941933744115
H	-10.83996777308661	-6.67366544339678	-0.93169660511551
H	-8.41307356439725	-6.50574693513308	-0.80102448426659
H	-7.06410530943339	-1.78501089218146	14.43612978120713
H	-8.01063975534706	0.44777044519604	14.25528350297130
H	-9.89989963737549	1.53623990787885	14.10502487002272
H	-12.31821952049369	1.32406103037629	13.99188988370372
H	-13.99192950527247	-0.09144766461964	13.97077430940841
H	-14.55375172043916	-2.45512993667287	14.06355269022161
H	-13.69292934043724	-4.45023488250612	14.23088497403161
H	-11.61093277438113	-5.68752338987643	14.43141065727296
H	-9.43152019810222	-5.49032862350395	14.54554999463699
H	-7.58871167002072	-3.90559838643109	14.54507316545031
C	-13.04907777327615	1.89277159977512	1.93138163006464
O	-14.24183031490647	1.84062083672590	2.09224920173755
O	-12.37906320350878	3.03777327651587	1.74220638269686
H	-13.03061975874162	3.75963149784260	1.78338225948389

Zn	-14.49845660212024	2.24388103939141	5.18113629211650
H	-18.39014250479167	0.19863473383146	5.33090456217434
H	-18.33373944291104	-1.47210998810819	3.46196831250544
H	-17.31572250648957	0.72807240526573	3.01506826630552
C	-17.82828463796329	-0.74694764506368	5.41291332557481
H	-18.51338769895040	-1.49120485896772	5.85175029962790
C	-17.40805534812153	-1.20746527467193	4.01462214651860
O	-17.14100145795363	-0.07662214633582	7.60436756908931
C	-16.66883352059489	-0.14136849175029	3.21073169487485
C	-16.65894955381008	-0.55664354512110	6.36495305062699
H	-16.33992438406927	-0.53625506558553	2.23511562005409
H	-16.38822934544686	-0.02658516826336	8.20748211867637
H	-15.93194456493996	0.15564311606411	5.92571778099171
O	-16.60790201292258	-2.37629509681529	4.18296800234654
H	-15.77130152966176	0.22117824847365	3.72862269141088
H	-16.24342157970833	-2.62571538600196	3.32420666998284
H	-16.13683992749723	-1.52072846343584	6.47674722181283

fCNTPVA03Zn

C	-5.76037695470512	-3.67087284333062	0.38205905065423
C	-6.11408547037834	-2.38619845298782	0.06555779894319
C	-6.84208326925914	-1.57979257335451	1.00961825458517
C	-7.91780440828701	-0.72838199014684	0.62067383302810
C	-8.35342629465327	-0.61890735423028	-0.75068640174589
C	-9.67880610819936	-0.51816014749058	-1.05258600613634
C	-10.68140795047912	-0.50964546939104	-0.00532529441436
C	-11.94259623731594	-1.06450213830203	-0.18465335529974
C	-12.29176674403140	-1.82417512791291	-1.38063487646762
C	-12.74868507872737	-3.09271219156297	-1.23071981690689
C	-12.87207931140978	-3.66913515991216	0.11460996508604
C	-12.47836081955313	-5.02279821326846	0.40712832665195
C	-11.85796662488026	-5.86587875246389	-0.56970334352892
C	-10.87686531296293	-6.75527534937380	-0.20297207263907
C	-10.44675677786574	-6.84676824848089	1.16089817834051
C	-9.05365041205784	-7.00516071712810	1.50489355209447
C	-8.03021001818224	-7.10212750215931	0.50325784873020
C	-6.86018061414171	-6.39957702769290	0.63874242347804
C	-6.65630413357935	-5.55489997451287	1.78221827038845
C	-6.11817034309950	-4.22781013814903	1.65898567899557
C	-6.37352149295057	-3.30150190717679	2.71239968294479
C	-6.73290416734327	-1.95500252917044	2.38743700336796
C	-7.35742453977164	-1.15151834293104	3.39192086239746
C	-8.42100779290643	-0.28467695039852	3.00581829626741

C	-8.83390557783589	-0.27664529964149	1.62721928223455
C	-10.21517274189285	-0.14771504252292	1.31873410688199
C	-11.15136072227286	-0.05040813306590	2.39826748814429
C	-12.40951178362954	-0.68057916658694	2.27892904269954
C	-12.90088611643140	-1.28471348681241	0.97057737026600
C	-13.10183636721794	-2.79342607560388	1.17393456150505
C	-13.34381441146994	-3.28781739695743	2.48366252479810
C	-12.98488274493162	-4.62842551331091	2.78819568555930
C	-12.35975980866717	-5.41507509615466	1.77145398566918
C	-11.33268145597415	-6.34124609099256	2.15451112460648
C	-10.97345369219407	-6.41804272547757	3.54087553607397
C	-9.59603355093853	-6.54441581491696	3.87318924071256
C	-8.63888200904240	-6.60386107875635	2.80576236925760
C	-7.41694986839908	-5.86444061500564	2.94841938126150
C	-7.22663144080764	-5.09968179961031	4.14433564755338
C	-6.68817223688616	-3.78681070375963	4.02534179798859
C	-6.88923057793481	-2.86160832138089	5.09304209318140
C	-7.22317589441150	-1.50620974061458	4.77072417438371
C	-7.84091050116414	-0.69481245524015	5.77021663420164
C	-8.89157047215626	0.19215684052372	5.38355417954045
C	-9.29638842414615	0.21868249689410	4.00935118288322
C	-10.68914202557471	0.33339150557465	3.70047921995723
C	-11.61938454740234	0.40138552865508	4.77769155883592
C	-12.83691480082552	-0.32798452758603	4.65902909859049

C	-13.09913437607715	-1.03943503632469	3.45152822441927
C	-13.62650955523740	-2.38587524979202	3.56152250360924
C	-13.91096829311357	-2.89926553452098	4.84644307334019
C	-13.56440092600046	-4.26053740351089	5.15529906070049
C	-12.92005105302138	-5.04323555160336	4.15673863146356
C	-11.88498653457134	-5.95554910486543	4.54109528514866
C	-11.51468242621916	-6.02521977788054	5.91721038324973
C	-10.12690540161192	-6.13564411369262	6.24731079961169
C	-9.17126698460240	-6.18190345694135	5.18814745572196
C	-7.95477405647181	-5.43664599882636	5.32691300441276
C	-7.75673822439550	-4.66908840201695	6.51308383712218
C	-7.20912245731419	-3.35342228699737	6.39565515337333
C	-7.40989246589644	-2.42757406818602	7.46836557721514
C	-7.72584771241485	-1.06615688358099	7.15128565427321
C	-8.33638372643008	-0.25541089512826	8.15064244254486
C	-9.38445288517891	0.64446716336117	7.76366583329485
C	-9.77889728696103	0.68736950833154	6.39305617217435
C	-11.17373695627415	0.79089098298356	6.08439134975698
C	-12.11006246764869	0.82888054219304	7.15428596745346
C	-13.32068355713889	0.06577083394142	7.03464755271045
C	-13.54760071018171	-0.67963597679647	5.84568240671362
C	-14.11133026821889	-1.99047227310308	5.94453835923719
C	-14.42446094494051	-2.49794856125457	7.23181560700044
C	-14.10867524736999	-3.86990716781110	7.53537174609600

C	-13.47379283084891	-4.65779171201074	6.52917765888600
C	-12.42585960098633	-5.55361566287018	6.91700798320734
C	-12.05011911046208	-5.61522054342053	8.29214175993622
C	-10.65647621482750	-5.71188183437904	8.61992618157426
C	-9.70399201508261	-5.75301732236871	7.56060250014975
C	-8.49265181125259	-5.00083259519983	7.69644437024428
C	-8.29163739513157	-4.23723041834124	8.88174664437322
C	-7.73428513926610	-2.92029872314707	8.76620984334647
C	-7.94607525044605	-1.99733580233332	9.83605243070335
C	-8.24679965716756	-0.64405839069560	9.52528311350152
C	-8.84939513527973	0.17109197793254	10.54132539220381
C	-9.89971747244678	1.07331431683307	10.15447196897874
C	-10.28708272726718	1.10891236517833	8.77169395935853
C	-11.67085492178040	1.19788689830104	8.46361819773965
C	-12.61242144869154	1.23802725860660	9.54662447667227
C	-13.82119618541437	0.46936456976890	9.42495199140871
C	-14.02427116816996	-0.28811167892874	8.22310649264896
C	-14.58915246337703	-1.58708341036188	8.32337584832318
C	-14.92360301975608	-2.08224252725648	9.62737343296783
C	-14.62414657885511	-3.45596932333192	9.92652913921253
C	-13.99711460583857	-4.25137850518041	8.90467446203455
C	-12.95291294193422	-5.13895281902449	9.29020216302989
C	-12.58105853146726	-5.19589373101809	10.67624147891509
C	-11.18387423123500	-5.27794309252895	11.00185330170749

C	-10.23663328835294	-5.30880668926123	9.92482867318754
C	-9.03668808431826	-4.55885654227561	10.05787683265576
C	-8.83361915763534	-3.80330491915679	11.26045357645779
C	-8.26925947404615	-2.48602266295308	11.14726419905015
C	-8.41552787802091	-1.57259073246785	12.22530651419809
C	-8.71303444563507	-0.18859147733251	11.91018000663722
C	-9.30118908825464	0.69486480076509	12.86993338292345
C	-10.30565102610108	1.55817625991007	12.49964604849911
C	-10.77708679288488	1.58527596074608	11.14870696389661
C	-12.19111050446564	1.66786186454756	10.83368769614760
C	-13.19458064947802	1.72176096269775	11.85277575233460
C	-14.35393521585323	0.98918952782772	11.73374221835612
C	-14.57472205269346	0.16048704390334	10.58782147849187
C	-15.14982709170756	-1.16879148204743	10.69339738649843
C	-15.52431944027505	-1.73239152308587	11.95299136915258
C	-15.24262800925530	-3.04861711292450	12.23865612006733
C	-14.56638553069898	-3.87110773101413	11.28277009203426
C	-13.50307107622430	-4.77995344525559	11.67465067071035
C	-13.07870371837511	-4.90093468796973	13.03415667145086
C	-11.73951759430058	-4.97428190015734	13.34515160930548
C	-10.75235957478613	-4.93287739366898	12.31218003396303
C	-9.52995154638025	-4.16270802184994	12.44622275131296
C	-9.24448558048246	-3.39276527197737	13.61777695044617
C	-8.70100617217878	-2.13357873541977	13.51075401007567

H	-5.33871376739823	-4.31387616448889	-0.39278731058653
H	-5.96491496921290	-2.02789869535447	-0.95453192607977
H	-7.62795206671022	-0.73307571378968	-1.55826332711041
H	-9.99745719142556	-0.55082441838476	-2.09578085508221
H	-12.08425214947459	-1.42734487280114	-2.37802772657565
H	-12.95092165563065	-3.71530789707689	-2.10460647171027
H	-12.06286426665285	-5.70924435849739	-1.63001500050773
H	-10.32184552622016	-7.28014551012287	-0.98223393622235
H	-8.23672185302422	-7.61376966891263	-0.43862684211957
H	-6.15992765159923	-6.36391933271582	-0.19782343372777
H	-9.06691921841493	0.58106890954561	13.92990043872564
H	-10.84323953762541	2.10676525559579	13.27522696398234
H	-12.98137102752811	2.21951583633404	12.80049980764879
H	-15.02848138736045	0.92674348817247	12.58955099453511
H	-15.89337303155916	-1.08630916120978	12.75165892451028
H	-15.39612113199233	-3.41130822327791	13.25655743144166
H	-13.80075965873727	-4.77624861835884	13.84312068366280
H	-11.43669066834187	-4.90560685983140	14.39155587981296
H	-9.59720349628788	-3.73376522145653	14.59283524205900
H	-8.63677809691463	-1.50933125409215	14.40375910690323
C	-14.26009068458348	-0.55979586735701	0.75017571889706
O	-15.32465443640534	-1.03729226814548	1.07853384906611
O	-14.09225219733295	0.67710093665303	0.31048688793367
H	-14.87680973315106	1.21872635514052	0.59108221725205

Zn	-15.82245174903748	1.98674295880364	2.72311962987423
O	-16.04946098696616	-0.45647028191172	3.72190540206976
H	-16.02992453785862	-0.82828734973310	2.82146250856717
H	-14.52947017745880	2.63037742433377	7.26132649141319
H	-15.45490095044386	1.12232346431664	5.57219612073291
H	-15.35734531108506	2.85999680530690	9.60874828053391
H	-14.82930837159307	4.43269379723444	8.97149108224925
C	-15.53646653816487	3.04914494372522	7.45084971847433
C	-15.57880023480043	3.63208102713823	8.85681628008233
H	-16.36517007864166	1.13960227877939	7.95955062174002
H	-16.82580677959541	-0.70395045847676	6.32363067877812
C	-16.50761421268980	1.35085413359594	5.81545552277218
C	-17.36424215105364	-0.44854600573296	4.24651490149480
C	-16.55759066533335	1.93755072451001	7.22654531027260
C	-17.30185842104247	0.05610374253915	5.68255653227206
H	-15.07078359210228	4.68709643824773	6.44120394287983
O	-15.81028432301933	4.06644295178985	6.47092189607304
H	-17.80893661026882	-1.46096846893593	4.22582954873115
H	-18.01854756043828	0.21736044998900	3.65151244887752
O	-17.00732253676404	2.28577723886184	4.85272569703619
H	-16.57348358444813	4.05739624108614	9.06462859115825
H	-16.66139270245410	3.15839167962809	5.12820717910251
H	-17.57360723965365	2.32495801818353	7.42067076303008
H	-18.33049466586922	0.20971671125120	6.05155650985066

ffCNTPVA02Zn

C	-6.85321058405054	-3.13842770403576	-0.07596966733228
C	-7.07389837752901	-1.78873346259949	-0.03797503837158
C	-7.45998050077403	-1.14636446231635	1.19343750984059
C	-8.44222841282630	-0.12181190598090	1.24604360677129
C	-9.11570307888772	0.36470173043755	0.06317160816644
C	-10.43822909565841	0.68202536972481	0.10352277247362
C	-11.20136705798347	0.55534339630450	1.33385397033300
C	-12.53801912048339	0.20342673597603	1.33966486488890
C	-13.23181776685798	-0.24152711121049	0.13742075774092
C	-13.86768768675907	-1.44054308928011	0.16143370699654
C	-13.80079023323238	-2.26822067016019	1.37265007137377
C	-13.54225417523455	-3.68854054422501	1.30618648616639
C	-13.28176932418713	-4.35484679960469	0.06963136309245
C	-12.39080298150425	-5.40204026098323	0.00795051355523
C	-11.70048330501223	-5.84177643625720	1.18028729590096
C	-10.31347588277738	-6.23950472609000	1.13852997278992
C	-9.55679046292942	-6.23028216841742	-0.08213316311735
C	-8.28550971862530	-5.71814059894119	-0.10027860810919
C	-7.70489335643499	-5.18806916317266	1.10274653106375
C	-7.01316458423148	-3.93149365687674	1.11582302368218
C	-6.89513064608984	-3.24463315959093	2.36078963866487
C	-7.11353393223532	-1.83284374440983	2.40289175729454

C	-7.40131942470126	-1.22497805351585	3.66245749597979
C	-8.38585287215467	-0.19672059666256	3.71865936813412
C	-9.06082366121808	0.18128111360766	2.50730324671421
C	-10.42548261439201	0.55871488773920	2.56097426651297
C	-11.10495171880788	0.51497923256960	3.81972592328132
C	-12.46789532434869	0.14153830681038	3.87268742142666
C	-13.28953253991771	-0.13324102857929	2.61768253602310
C	-13.65815826608832	-1.62170908255583	2.59486258893095
C	-13.66905196242176	-2.35183171337436	3.82056338017109
C	-13.43220686095418	-3.75756672172595	3.76935265603547
C	-13.17819515036680	-4.36931612039723	2.50237148841384
C	-12.25322903068671	-5.46423895672077	2.43904128845770
C	-11.62476964946476	-5.89745498215218	3.65052402666932
C	-10.25375542741764	-6.27709816786193	3.60858909775029
C	-9.56843496695936	-6.20757021275093	2.35079124328355
C	-8.23612538002572	-5.67478579312231	2.33439594357488
C	-7.67512319555651	-5.22833872581239	3.57284875474899
C	-6.98409853403702	-3.98366807448641	3.58704718815195
C	-6.81630824971855	-3.30829941678557	4.83320240362779
C	-7.03590434751597	-1.89431183312364	4.87248346012598
C	-7.31227250474353	-1.27522410496324	6.12986029059456
C	-8.28961096569528	-0.23941487243159	6.18525191491715
C	-8.95863501704043	0.13666203366534	4.98012840371156
C	-10.34463678205920	0.47660336701200	5.03557112672832

C	-11.02518893587432	0.44377347191611	6.29830958610597
C	-12.38677035941302	0.07281825682481	6.31814187404382
C	-12.97299195129823	-0.34621070337598	5.09594546095592
C	-13.60248503702652	-1.67176912867096	5.07295951307329
C	-13.60323190618693	-2.42288038416195	6.28406705390438
C	-13.37972341511780	-3.83939480978355	6.22664844668274
C	-13.11949436712187	-4.45739642512955	4.97082364755617
C	-12.20121364244922	-5.55266876288317	4.91211940017649
C	-11.57342425928899	-5.99128241401322	6.11699040376855
C	-10.19395710678089	-6.36289002699374	6.07478017589000
C	-9.50539513685700	-6.28763614464030	4.82539715984800
C	-8.18272274269343	-5.73956809967077	4.80908696660430
C	-7.61191249776169	-5.29386544400147	6.04065098982295
C	-6.91196230461260	-4.04774754487228	6.05232317311970
C	-6.75186444559211	-3.36438478629200	7.29941104674542
C	-6.94353706991457	-1.94984527507112	7.33731456907145
C	-7.22555767815269	-1.32894839506451	8.59058036633406
C	-8.19630935930549	-0.28886780667948	8.64774279155431
C	-8.88191850151857	0.09496662562639	7.44834270596377
C	-10.24936962220950	0.46475741066877	7.50830163714296
C	-10.93275255340378	0.36375039649134	8.76965766439842
C	-12.26929832589668	-0.04734430986734	8.83243224692564
C	-13.13334047415575	-0.28389288708141	7.60102376598133
C	-13.50091407058324	-1.76962967210936	7.54735889122863

C	-13.54851531573906	-2.50752782516873	8.73171549535951
C	-13.33798773323215	-3.92855095034121	8.68505549361107
C	-13.07200245593543	-4.54264924481580	7.42932531576580
C	-12.15391871411681	-5.64109060556364	7.37529222388268
C	-11.52498268894715	-6.06291412225999	8.58004561174670
C	-10.13905303812480	-6.41589906164992	8.54089982810026
C	-9.44603742575788	-6.34919321559975	7.29473293788426
C	-8.12314395753408	-5.80273455854520	7.27806276108590
C	-7.56038532155442	-5.34720529965869	8.50710501965583
C	-6.85923367903824	-4.10111403709602	8.51797925254080
C	-6.69936758707237	-3.41841425016146	9.76637682040154
C	-6.88075342896089	-2.01127256429623	9.80330860165552
C	-7.12333362511943	-1.38334154329235	11.06783684057430
C	-8.08721250758455	-0.31821760331229	11.12642323745950
C	-8.76820545511127	0.04651637720083	9.91728091838572
C	-10.14554844932706	0.36980001949517	9.98156253868899
C	-10.79718402082732	0.31508301334073	11.25373123499168
C	-12.12826214671531	-0.22056357308921	11.29444301017832
C	-12.73631730953395	-0.60773186604746	10.05750387924015
C	-13.43100718932173	-1.85051498699867	10.02098789517269
C	-13.53122718399769	-2.60690728655390	11.22196131056564
C	-13.34084874011251	-4.03911667114978	11.16418446042014
C	-13.03174971862022	-4.62919651667114	9.89051554123229
C	-12.10402602635129	-5.70320322317467	9.83784355153049

C	-11.48075066206249	-6.12801046388391	11.05579838206240
C	-10.08472727662595	-6.46838105983055	11.01915767936311
C	-9.39647237426040	-6.38115137438121	9.76385593002520
C	-8.08646994522256	-5.83448860770167	9.74678623183557
C	-7.51785514051155	-5.39248469733015	10.98688378188944
C	-6.79565380223602	-4.14933898227054	10.99629789832587
C	-6.58174525842395	-3.48114222059637	12.23193783531175
C	-6.74114103931094	-2.04538019671667	12.26805321242007
C	-6.95986436767243	-1.33519622322298	13.49473531926520
C	-7.87745079050547	-0.31687005022149	13.55091265379067
C	-8.63101103765396	0.05315263686290	12.38662170180966
C	-10.03451012189887	0.37437063959883	12.45540113256482
C	-10.76563021613927	0.31355815724883	13.68962314881944
C	-12.02548236551717	-0.22881734143742	13.72320682605774
C	-12.63554420199151	-0.72645751358819	12.52168212853019
C	-13.37809546992127	-1.95998326202145	12.48647318968262
C	-13.56546069263212	-2.76582739879440	13.65988378398145
C	-13.42560077748124	-4.12742397918998	13.59765921590104
C	-13.07043209034233	-4.75768519525181	12.35403325049972
C	-12.09465273925414	-5.82735094709534	12.30187682538199
C	-11.42864390179984	-6.30082928831279	13.47810087755375
C	-10.09016322732092	-6.61247829855050	13.44425401482222
C	-9.34195136853807	-6.47964538073632	12.23086566700091
C	-8.00827782169628	-5.91708130601880	12.21404970585461

C	-7.36199629928703	-5.46546779252978	13.41145932574617
C	-6.66910935587855	-4.27994778083194	13.41965302480159
H	-6.70111813560347	-3.62868722248882	-1.03936601382779
H	-7.08874853595625	-1.22487221120927	-0.97242490027508
H	-8.58953193702090	0.37511835227715	-0.89334333840952
H	-10.95798845110594	0.94365758762697	-0.82011712633098
H	-13.15706117809988	0.32174638781274	-0.79703537899979
H	-14.34324115340087	-1.83561276991364	-0.73819341754654
H	-13.68291866386967	-3.94672065028940	-0.85910902517035
H	-12.10468553452107	-5.79389004064846	-0.96942154310136
H	-10.04186088152978	-6.48453843721603	-1.02622374909376
H	-7.78308368075975	-5.57282774596630	-1.05842491187245
H	-6.50632501085620	-1.69397561490140	14.42041333336568
H	-8.13153364151605	0.11435364236709	14.52086180594956
H	-10.26733505196371	0.55491425878164	14.63017819486400
H	-12.50069842189009	-0.40859854277390	14.68946065364812
H	-13.68372259047188	-2.28634782621757	14.63377630658884
H	-13.44391803637885	-4.71023608427355	14.51998675901081
H	-11.93890208691361	-6.26975093114180	14.44196610279967
H	-9.57225411537785	-6.81784121167602	14.38285981681276
H	-7.54792106165963	-5.97736465034468	14.35725986569643
H	-6.31854270136324	-3.87901162337552	14.37237875944626
C	-14.37668766257148	0.64179180944113	7.69046850914919
O	-14.27808481413714	1.84580164286594	7.78506307658804

O	-15.52075839118102	-0.01796212073871	7.60885080794189
H	-16.30327364287732	0.59847641688025	7.54047703965742
C	-14.56954963267875	0.73615941421765	2.74638182887041
O	-15.64766032467298	0.28289595964106	3.05784790743886
O	-14.30846760571054	2.02018985760582	2.56679575912266
H	-15.03062083257144	2.56879716042763	2.98987746874624
Zn	-12.73707908470062	2.98427466882878	5.70874678921361
H	-17.73594136002605	1.87787730274940	3.89099031442046
H	-19.32468888462257	1.04043123188393	5.71302668954636
H	-18.13031106970873	-0.59103131678588	4.29079481001631
C	-17.65460305274367	2.14093842339171	4.95684853066505
H	-18.25873271687769	3.04723509072849	5.12557657285888
C	-18.22304890555455	0.98279585786398	5.77843453925063
O	-15.73942764047947	3.41140151411685	4.29071217723327
C	-17.78048185732086	-0.40242620162007	5.31622712838980
C	-16.20385812117745	2.46786110486966	5.26497608831504
H	-18.20356786686538	-1.17870667699968	5.97566939041608
H	-14.89652724777627	3.77220880585029	4.62818829915020
H	-15.58540516446682	1.55640448013466	5.23024811095100
O	-17.85951153938079	1.20643342340066	7.16558875088260
H	-16.68828959660213	-0.50826963207354	5.31227335620845
H	-18.44716447265884	0.67598463151005	7.72100958781816
H	-16.10262108573428	2.89184881375838	6.27457372543134

ffCNTPVA03Zn

C	-6.42282556060944	-3.14966088377812	0.05601240766092
C	-6.73502345803894	-1.81673617698064	0.04677322182374
C	-7.22728923603047	-1.17382935358944	1.23814284903288
C	-8.27898230346432	-0.21482782093396	1.21134761403442
C	-8.91807281165948	0.19178325695186	-0.01812344314473
C	-10.26089082959749	0.41218726364553	-0.05750841168766
C	-11.08001274932964	0.26082625673644	1.13240261066809
C	-12.38989413497439	-0.18547699226484	1.07319632897746
C	-12.97481260029816	-0.71032111246292	-0.14980678086597
C	-13.54567268676597	-1.94439493386996	-0.12739121478621
C	-13.49441530795780	-2.73344405978643	1.10703575131730
C	-13.12920944542175	-4.13338299605581	1.09326714776232
C	-12.75586935339727	-4.80815886434732	-0.10873100077729
C	-11.79186672002278	-5.79111500943511	-0.09483915967677
C	-11.13845786388355	-6.15527312187885	1.12283797457517
C	-9.72602162306165	-6.45522720943545	1.16551927753324
C	-8.90633617010337	-6.42029273785731	-0.01234378378648
C	-7.67334623700256	-5.82139415432860	0.02408751808071
C	-7.19643343529554	-5.22669448606768	1.24143899446388
C	-6.59159512318734	-3.92356846513797	1.25767902255224
C	-6.59004063322597	-3.20198330480014	2.48751339999552
C	-6.90378248331267	-1.80660813719991	2.47994278644640
C	-7.30569752130369	-1.19205597905912	3.70556923159185

C	-8.35832643516571	-0.23425605462485	3.68080334888733
C	-8.98742218823346	0.07079176890429	2.42647009681696
C	-10.37766083208556	0.35618193519126	2.39615880802843
C	-11.12366710334146	0.28575336525959	3.61526338883408
C	-12.46340564454097	-0.17191366539429	3.60699911327667
C	-13.19470872454814	-0.53717033096451	2.31785392146005
C	-13.45875812230583	-2.05059693840280	2.31847218853385
C	-13.47783705577561	-2.75158029887526	3.56016225639369
C	-13.14653865602212	-4.13867089194749	3.55937317884458
C	-12.78329297603537	-4.75945539297736	2.32409793541966
C	-11.78346184077442	-5.78823123152935	2.33943911227477
C	-11.19400614020545	-6.14767425182607	3.59406664251527
C	-9.80023664475298	-6.43076679467926	3.63532188249953
C	-9.05309578180566	-6.34279152362253	2.41437238041348
C	-7.76080212214754	-5.71928312670807	2.45450157364412
C	-7.30154243076165	-5.20487504830863	3.70918980879172
C	-6.69818960091990	-3.91660095791172	3.72635435941441
C	-6.64556800070330	-3.20188463745277	4.96172196705009
C	-6.96230285476169	-1.80578899337479	4.95086088683632
C	-7.34908134954551	-1.17846894795243	6.17394228582285
C	-8.39996776785526	-0.21288354964174	6.14809475001221
C	-9.02471832201504	0.08591304032933	4.90089077995076
C	-10.43279618943289	0.33016890514491	4.87223411405198
C	-11.17825779788599	0.28063359661477	6.09729235051290

C	-12.51669441801541	-0.18216558604214	6.05339426868285
C	-12.98977725884006	-0.68106359973683	4.81500782385663
C	-13.52363908650878	-2.04075309756076	4.79397110332446
C	-13.55491756002099	-2.76274411231460	6.02270825209181
C	-13.22742429303413	-4.15872505642046	6.01667387287016
C	-12.85484920236303	-4.78686580093853	4.79333187002393
C	-11.86172892821621	-5.81499022860415	4.81332222781698
C	-11.27281171434490	-6.17960239765381	6.06189638928117
C	-9.87064503562041	-6.45429911015563	6.10296205013344
C	-9.12105693564838	-6.36015563762550	4.89059806565320
C	-7.84014192356843	-5.72184838040675	4.92999706421201
C	-7.36942910124393	-5.20938688055330	6.17781138274439
C	-6.75724228053073	-3.91683157094096	6.19268088607331
C	-6.71418618456962	-3.19456841112147	7.42749182381142
C	-7.00427516571236	-1.79729913655789	7.41598171169509
C	-7.39959125079984	-1.16870518421758	8.63667326036901
C	-8.44035950084015	-0.20150711355099	8.61330571949310
C	-9.08396397039940	0.10543262223521	7.36799106441539
C	-10.47441433334663	0.37752939445415	7.34320088303918
C	-11.21795830229846	0.25186662377042	8.57277497443437
C	-12.51880342127865	-0.25085389732102	8.57440846768448
C	-13.29796745911903	-0.55541479794696	7.30759810294494
C	-13.57839697273396	-2.07597865246641	7.27132858692184
C	-13.63583155890299	-2.78579862307061	8.47194567960953

C	-13.32024374853449	-4.18915358711756	8.47433441597598
C	-12.93997970142055	-4.81028141156951	7.25259596949449
C	-11.94501060978503	-5.84198899599373	7.27686986786234
C	-11.35441711611660	-6.18728251144958	8.52445996244320
C	-9.94848042339298	-6.44452034619263	8.56900577700847
C	-9.19382732725227	-6.35850920711282	7.36021361447200
C	-7.91256299391250	-5.72221416172650	7.39896503066172
C	-7.45211326124771	-5.19779677594338	8.64431708222873
C	-6.83828645890253	-3.90827357113081	8.65871841256481
C	-6.79340370830640	-3.18681293934737	9.89551046122907
C	-7.07215253237269	-1.79524329334908	9.88461282787765
C	-7.42627694674547	-1.15656351944987	11.11643064510122
C	-8.46403496085086	-0.16176920045630	11.09466850643231
C	-9.10259374369939	0.12309167306677	9.84268309973274
C	-10.49988503241740	0.34697212957802	9.82528267330705
C	-11.21458594110320	0.27633516396772	11.06093850528052
C	-12.50489556369982	-0.35255136724739	11.04491813199508
C	-13.01218229673989	-0.81337275889916	9.79156841323620
C	-13.62402397143681	-2.09376347087849	9.75217590262912
C	-13.74154667235190	-2.82777019424209	10.96397996612852
C	-13.45117183682623	-4.24459947217284	10.95343564287328
C	-13.02985134187503	-4.83742439925990	9.71373912845377
C	-12.02701899655849	-5.84207845286830	9.73977929078475
C	-11.44418640975682	-6.19459262544922	10.99970126696294

C	-10.02772181172470	-6.43511823614523	11.04704304848761
C	-9.27880294738876	-6.32875479500661	9.82902137421081
C	-8.01028849720628	-5.69275749331937	9.86722963462198
C	-7.54235324438655	-5.18349492838471	11.12303212442722
C	-6.90735010870593	-3.89365308817095	11.13716580984024
C	-6.80946569642248	-3.18280443442617	12.36447937715441
C	-7.06682286977412	-1.76284659869265	12.35311930729656
C	-7.40126133095438	-1.04062685116502	13.54764899608480
C	-8.38897069901676	-0.09006462369022	13.52766641579521
C	-9.10318297209437	0.19640276834818	12.31441186883066
C	-10.52494686351064	0.41756773039120	12.29954014975169
C	-11.31848662208558	0.33442142460138	13.49554981156294
C	-12.53643768866363	-0.29417859439445	13.47701091934223
C	-13.04182617282983	-0.86547429512336	12.25766636901603
C	-13.69724279300899	-2.14319003091098	12.21719395180499
C	-13.89547669715459	-2.93419693718166	13.40154332866248
C	-13.66266463466139	-4.28250795994638	13.38204514713551
C	-13.19491437526202	-4.91390052268670	12.17406797656070
C	-12.14561031661528	-5.91039573925304	12.20269606918241
C	-11.51345131632478	-6.30699853180417	13.42601282326755
C	-10.15718294960788	-6.52256671138677	13.47249318836165
C	-9.35398921370470	-6.36381044184982	12.29697863632520
C	-8.06382369968355	-5.71149998292534	12.33612098005086
C	-7.51591742800348	-5.18842903712873	13.55428638340244

C	-6.90618648969454	-3.95884872910138	13.56765570693805
H	-6.18985662151242	-3.65020170295076	-0.88566858909485
H	-6.73976247108977	-1.27824798631493	-0.90261135652664
H	-8.34288963989204	0.21591803515169	-0.94577538298724
H	-10.74519434618962	0.60939964387876	-1.01578895798138
H	-12.86355807510778	-0.17803021481393	-1.09883169592582
H	-13.93194067106290	-2.39402794512522	-1.04381339941829
H	-13.13152508855777	-4.45073896019359	-1.06840769097341
H	-11.42591131962470	-6.18282503140404	-1.04530615744613
H	-9.32054837083806	-6.72710382078305	-0.97437336201740
H	-7.13144756509014	-5.66156826221342	-0.90991773373874
H	-6.97265481543813	-1.34291534304097	14.50487875898249
H	-8.72416592147230	0.34678047075648	14.47005220575524
H	-10.89237869356269	0.63810570355137	14.45341400872621
H	-13.05445715549194	-0.47956724183737	14.41989547928418
H	-14.10560628667916	-2.44183280034480	14.35328596104449
H	-13.69820713082030	-4.84727324756366	14.31499630563961
H	-12.07799432318630	-6.29206998165457	14.35950057774090
H	-9.67858629431902	-6.67020111283390	14.44227242873932
H	-7.71645156869710	-5.69149142961740	14.50185729962858
H	-6.63439954365726	-3.51314659322996	14.52618034073790
C	-14.65210837093828	0.20357473292821	7.35400862764136
O	-15.00660060426408	0.84304156152184	8.32911522149758
O	-15.37621729670868	0.05133349754482	6.26277362782116

H	-16.23985941166356	0.55980178894756	6.38859609725791
C	-14.53656193151321	0.23160206780811	2.32640273394716
O	-15.58838698756296	-0.22129657658201	2.70258189982852
O	-14.38140160920233	1.49822563530232	1.90661117150749
H	-15.23354623241760	1.95125688412526	2.02771864287671
Zn	-13.37415755815540	2.44557658283396	4.98060475441528
O	-17.36505785905330	1.45091271829095	7.16761256327071
H	-16.75769276718144	1.40729034103548	7.93294655097786
H	-17.70025186562431	0.83255699386659	2.08863409320337
H	-17.70227188518223	1.28409393009947	4.48253550905394
H	-16.65655103229307	2.26176674263441	0.33151778805937
H	-18.16175555624338	1.55135864293263	-0.28075385765117
C	-18.13577068124762	1.82580359175835	1.87730990180575
C	-17.75091462871488	2.25268267949342	0.46428870607781
H	-16.53994614894202	2.88999020740077	2.87453100992448
H	-16.14511282909951	2.99270248484719	5.29157734954141
C	-17.99422014303480	2.35086447867244	4.37858202997265
C	-17.62789961410519	2.82280345192315	6.85414573133191
C	-17.63687472188545	2.78861192856263	2.95272520638611
C	-17.22934107672724	3.15713222974198	5.42474060398247
H	-19.88471289771942	0.99705363264096	1.51210951496601
O	-19.56492547169353	1.76137512303995	2.00840889824647
H	-17.07885941893430	3.47638989388916	7.55330381745100
H	-18.70626189868871	3.00787620529287	6.97923586404272

O	-19.37538002983119	2.51530356121876	4.62634811987844
H	-18.13997220334900	3.25900716523033	0.24239800033733
H	-19.83172989269070	2.16132744264364	3.84416364553160
H	-18.05624608369633	3.79453326967711	2.77441246491055
H	-17.42170762802436	4.23154254729196	5.25582567562199

CNTPTFE

C	-6.66763433832861	-3.09490041656784	0.00086603830962
C	-6.92785886114884	-1.75440690685458	0.00230924849482
C	-7.36450168603947	-1.09860937651538	1.21248526421456
C	-8.41006958832901	-0.12353392945045	1.21236173501339
C	-9.09544246355866	0.26508908696654	0.00225867127970
C	-10.45075811621258	0.43215028465270	0.00142009937353
C	-11.21144135002897	0.22147206026636	1.21065762237742
C	-12.46206305613233	-0.47125788666888	1.20937059949565
C	-13.04289146763442	-1.00225236584601	-0.00131981884922
C	-13.62033904425556	-2.23970934180454	-0.00322926887308
C	-13.65532426471576	-3.02908884290255	1.20542700338456
C	-13.38315656150780	-4.43261342841656	1.20333881035191
C	-13.05559449371817	-5.14783470826919	-0.00758062162351
C	-12.05696743597777	-6.07923526502170	-0.00877284044215
C	-11.31940716693815	-6.35796607690539	1.20096613570563
C	-9.90039657775471	-6.53245923510559	1.20151297479588
C	-9.11635080083797	-6.44006719167527	-0.00756180892105

C	-7.92173703169609	-5.77853431662042	-0.00525052746680
C	-7.43149801567249	-5.16448163631833	1.20627702905299
C	-6.82648106915144	-3.86915049756234	1.20936335766660
C	-6.76236042723298	-3.15393431736362	2.44195124822672
C	-7.03665858790201	-1.74061814195137	2.44346314526813
C	-7.39458155112823	-1.12246286445908	3.68084935301462
C	-8.43115148917715	-0.15395229501524	3.68065992387939
C	-9.07267786529699	0.15990116324645	2.44338174100228
C	-10.50150310418315	0.33603589687210	2.44259932019021
C	-11.20177429368426	0.18722846428874	3.67911812290422
C	-12.44168950707720	-0.50138418077350	3.67778744640114
C	-12.93700335641154	-1.01455476141218	2.43988761970845
C	-13.54531624520931	-2.31927343750372	2.43788261843086
C	-13.62064591134749	-3.03187262527176	3.67389628120147
C	-13.35098018001029	-4.42428942884112	3.67184604023755
C	-13.01529873163580	-5.05344102802231	2.43380679954437
C	-11.96308042091414	-6.03589849149313	2.43260453577477
C	-11.31138413367347	-6.33016608534805	3.66945133880650
C	-9.90382023639942	-6.50420595552846	3.66985683658321
C	-9.19893889924211	-6.37618762261749	2.43372975320542
C	-7.93982273841974	-5.67804907011323	2.43618954235779
C	-7.46267161499636	-5.14938237708810	3.67471719594315
C	-6.86309435368372	-3.86375335907626	3.67781274591111
C	-6.77665347272460	-3.14683789670009	4.92265146363026

C	-7.04518757944853	-1.75702583192936	4.92411734022912
C	-7.38403468827109	-1.11778780529675	6.16112249601595
C	-8.42696579993851	-0.13790659116284	6.16203521821746
C	-9.08752644136703	0.15449238042755	4.92404530531668
C	-10.49247415472378	0.32708742951692	4.92368459869817
C	-11.20575613977477	0.20300768565089	6.16126121626818
C	-12.45656470128720	-0.49304654543860	6.15981617253357
C	-12.93667770708162	-1.03173779102419	4.92101499639461
C	-13.53425688880660	-2.31488278653046	4.91898434661482
C	-13.63856393305363	-3.03240135580733	6.15567601440221
C	-13.36675443177888	-4.43780446810542	6.15367542463734
C	-13.00250401176294	-5.06080843026854	4.91494189823319
C	-11.96883777291990	-6.02783713273084	4.91380633823025
C	-11.32166907883341	-6.35128863951118	6.15150441238236
C	-9.90120681636603	-6.52829465206695	6.15183763555025
C	-9.19358083271184	-6.37155102153980	4.91465368586762
C	-7.95592056817237	-5.68459580243389	4.91667889722690
C	-7.45429986613096	-5.16826345678187	6.15586477242735
C	-6.85515176948520	-3.86871018246802	6.15806471114252
C	-6.77970269777479	-3.15592160293208	7.38891071168677
C	-7.04337018406895	-1.75076901746939	7.39067838201300
C	-7.40108997910921	-1.12624396233968	8.62951513895767
C	-8.43196913258151	-0.15729027734609	8.63070432659338
C	-9.07952275562743	0.16528115510874	7.39258431683987

C	-10.50001483563116	0.33961003977382	7.39219558148922
C	-11.20675055353209	0.18277149971995	8.62997837510794
C	-12.44347015277005	-0.50551121715338	8.62822217945084
C	-12.94699818542342	-1.02212477499211	7.38909444468901
C	-13.55097868282333	-2.31972504699620	7.38685590113439
C	-13.62394119614634	-3.04126569978546	8.62360391178128
C	-13.35529910522376	-4.43089031533731	8.62167893555031
C	-13.01896155121014	-5.06973918539600	7.38296830230977
C	-11.97404308641504	-6.04792150796201	7.38201086111895
C	-11.31308376124296	-6.34172240024279	8.62017109017239
C	-9.90868955579752	-6.51695223755583	8.62071759064739
C	-9.19539822850152	-6.39382626768344	7.38285350967453
C	-7.94486235357441	-5.69819231015402	7.38435885015444
C	-7.46669502667775	-5.15821696879600	8.62363309530641
C	-6.87760893538714	-3.87290415023411	8.62589012039871
C	-6.78246374496294	-3.15586650607484	9.86946556338370
C	-7.05010362109362	-1.76299471970461	9.87140193210382
C	-7.38336379406534	-1.13336244706854	11.10926643133125
C	-8.43570979873669	-0.15047892835550	11.11130231682469
C	-9.08836045891170	0.14503890834356	9.87523020864297
C	-10.49621563399225	0.31751004278994	9.87481494058900
C	-11.20007773676261	0.18908034995372	11.11136099298136
C	-12.45855669781908	-0.50987621702919	11.10942828149179
C	-12.93594578145686	-1.03894821492919	9.87112903025250

C	-13.53480812768883	-2.32465619403113	9.86871684738742
C	-13.63521800662250	-3.03433580889271	11.10453803652578
C	-13.36172163228224	-4.44768254454635	11.10262426460625
C	-13.00447235698212	-5.06558899678646	9.86502797801845
C	-11.96869119380758	-6.03461272004787	9.86436040224287
C	-11.32712468281012	-6.34940265576575	11.10156415529855
C	-9.89839116354976	-6.52598720837605	11.10220541124706
C	-9.19874317594542	-6.37827967943442	9.86553494844181
C	-7.95893130875744	-5.68940484369920	9.86705922278958
C	-7.46312676469789	-5.17385483994840	11.10376381002482
C	-6.85476149901879	-3.86882976869761	11.10490920740497
C	-6.74350893861513	-3.15873843706624	12.33707166470090
C	-7.01548014319136	-1.75519941758821	12.33941739894444
C	-7.34216961151214	-1.04002292979391	13.55077802897530
C	-8.34072811132119	-0.10867146724749	13.55271849827997
C	-9.07893498340570	0.17073195534521	12.34335518618158
C	-10.49780705634825	0.34525838158537	12.34337320594054
C	-11.28132100610427	0.25269512938882	13.55287663640570
C	-12.47568721065162	-0.40915844192787	13.55102680730332
C	-12.96607709270651	-1.02362948341854	12.33967515895336
C	-13.57044680676270	-2.31907532556020	12.33712060631757
C	-13.72908851656046	-3.09339333678947	13.54568587803873
C	-13.46953652996784	-4.43397989434117	13.54394031574842
C	-13.03383844884118	-5.09002572451136	12.33347556083078

C	-11.98909742520246	-6.06567233448683	12.33295080540519
C	-11.30331016883842	-6.45446507392983	13.54296423307287
C	-9.94802549828839	-6.62086808911657	13.54351881829262
C	-9.18779945831050	-6.40991282398725	12.33391706896550
C	-7.93772023927717	-5.71653311352388	12.33482166162050
C	-7.35606077347332	-5.18501000500717	13.54509599385623
C	-6.77798131233711	-3.94792039327337	13.54605439892821
H	-6.46572511412718	-3.60095854463828	-0.94497524182988
H	-6.93051416448184	-1.20759999687260	-0.94238834784803
H	-8.55052429891159	0.29885117551119	-0.94293406271156
H	-10.97006534134743	0.59712695874309	-0.94439027715166
H	-12.90647210616645	-0.47276187740815	-0.94604391703301
H	-13.93760903235769	-2.68187361385351	-0.94942198692230
H	-13.51545129843981	-4.85355201475431	-0.95277918631510
H	-11.73242288331221	-6.51620176661653	-0.95491665512368
H	-9.53630428011461	-6.78514064705271	-0.95415994029136
H	-7.40381033754879	-5.60377798842897	-0.95004916563168
H	-6.88164302510092	-1.33449295958548	14.49558140843874
H	-8.66445781055666	0.32847227898215	14.49906953110274
H	-10.86115423077977	0.59842208254336	14.49914102593550
H	-12.99323339491981	-0.58422396607208	14.49598407001820
H	-13.93036184770799	-2.58730910086011	14.49164601923169
H	-13.46691560630876	-4.98100565285428	14.48851264087853
H	-11.84823587555071	-6.48889464770207	14.48812694610990

H	-9.42825844906184	-6.78552140943829	14.48913823870547
H	-7.49153163434418	-5.71442614877250	14.48999713296001
H	-6.45952873358218	-3.50557762483584	14.49175959691545
F	-3.69480189742432	-4.45414296265353	6.64156713582263
F	-3.98394618722869	-1.72368411134389	6.29744701989815
C	-3.73843693153842	-3.60407967399448	7.64586334450244
C	-3.87988282967736	-2.29261096589885	7.48001286616014
F	-3.69869774992150	-4.18100518030530	8.82865380622114
F	-3.99048477638427	-1.44626017422129	8.48248220857744

fCNTHg

C	-6.53068002088321	-3.17625023806490	0.02847334082496
C	-6.84331477344299	-1.84322225219702	0.01277057596396
C	-7.31405577574982	-1.19352234089845	1.20830504119440
C	-8.37620837197034	-0.24372442820682	1.19650960839250
C	-9.05331393693391	0.13492246944566	-0.02056867080964
C	-10.39960419995168	0.34225918725294	-0.02803515211415
C	-11.18007111898346	0.19658033059790	1.18598933331652
C	-12.48603043794378	-0.26908382951148	1.17038767132691
C	-13.11105261050175	-0.79069857499851	-0.04125192630441
C	-13.62525396288580	-2.04522946890852	-0.01215791960601
C	-13.52700256108804	-2.84329681978253	1.21695977679292
C	-13.18767942770060	-4.24110135291149	1.19379723205703

C	-12.83717243125104	-4.92328418051792	-0.01557750335163
C	-11.87492224494765	-5.90371177640638	-0.01072226729660
C	-11.19494585802231	-6.25292668940415	1.20169160916893
C	-9.77848204089427	-6.52836447690957	1.22204136810528
C	-8.97921256565519	-6.48378480427476	0.03023670567517
C	-7.75640096481918	-5.86343567002544	0.04002961874448
C	-7.27216761003487	-5.24666298505009	1.24371595869788
C	-6.67300053363292	-3.94079425246730	1.23890794967302
C	-6.65032123482832	-3.21058792703150	2.46347520431693
C	-6.96800970846926	-1.81549001511020	2.45113278251032
C	-7.32789667844714	-1.18420416955433	3.68201617026094
C	-8.38062331522401	-0.22324162218877	3.67286399532253
C	-9.04789116674267	0.05256443265384	2.42918394030118
C	-10.44801626789053	0.29556512305380	2.43324811623032
C	-11.15491178844238	0.23783511122250	3.67833940805695
C	-12.46837942501059	-0.28744829906807	3.71082073910928
C	-13.23097815146004	-0.64541036667918	2.44171991802050
C	-13.48345557062762	-2.16167442176074	2.43193118355609
C	-13.50509178558574	-2.86851700097179	3.66268006816169
C	-13.19035777982541	-4.25421846793720	3.65972804522716
C	-12.83569087140436	-4.87267011339995	2.42084523675485
C	-11.82926177792771	-5.89542725621560	2.42559008805712
C	-11.21566152184728	-6.23425546437361	3.67598716308720
C	-9.81455000785360	-6.47926295872121	3.69401969297881

C	-9.08973399924528	-6.38535805734708	2.45927380860939
C	-7.81116699794444	-5.73311416256389	2.47176675813142
C	-7.33595047431619	-5.20445027979053	3.71487424508246
C	-6.73714667878518	-3.91253963067986	3.71150411084161
C	-6.66058014919818	-3.18743039798764	4.93818345532597
C	-6.95486543841346	-1.78582024546953	4.92406675641371
C	-7.30812066806231	-1.14536469086361	6.15010116904085
C	-8.34791491207477	-0.16619362200039	6.14093712962389
C	-9.00814773896666	0.12304637629749	4.90258463670723
C	-10.42075896492084	0.35368544973126	4.90661677160591
C	-11.11696030428553	0.27245912560967	6.14763617168391
C	-12.39204799118477	-0.36330276653194	6.15800560758328
C	-12.94027432746351	-0.83020305747010	4.92367808858468
C	-13.52097684654276	-2.16171466719470	4.91131768062295
C	-13.58033007393957	-2.88776818519373	6.12407524663461
C	-13.27390921054503	-4.29362224331007	6.12263396146238
C	-12.89227456991490	-4.90826566832135	4.89728205802689
C	-11.87757880643052	-5.91874173624452	4.90380222935200
C	-11.25554806749573	-6.25137570210398	6.14354332798673
C	-9.84360270824786	-6.48233680061848	6.16062381698185
C	-9.11688015949294	-6.37723351924866	4.93649146185302
C	-7.84317857019890	-5.72060321186678	4.94749767351391
C	-7.36261332704848	-5.18718425611036	6.18045950073115
C	-6.75414985983619	-3.89326925279433	6.17690918680120

C	-6.67595801578064	-3.16776172977752	7.40765357795816
C	-6.95157818190157	-1.76140224470341	7.39524294716434
C	-7.29687767967787	-1.12130970523956	8.61941289061778
C	-8.33187011203818	-0.12845766809825	8.61161253772281
C	-8.98203059427620	0.17502562013807	7.37826901227346
C	-10.39727424705801	0.39529121102739	7.38321919769227
C	-11.10230090997111	0.28220768244223	8.61354825711866
C	-12.37389628579355	-0.38452073307346	8.61774898026352
C	-12.88422834268542	-0.89325583854914	7.39057085328518
C	-13.50286186496686	-2.18497178739342	7.37923498554421
C	-13.58928071784591	-2.90478877861480	8.59936182874214
C	-13.31730720652830	-4.31847797086732	8.59501070842288
C	-12.94811143101338	-4.93458832407200	7.36202159746347
C	-11.91728406161262	-5.92885669088187	7.37195365690505
C	-11.28976054737643	-6.25511006260745	8.61110263583233
C	-9.87148460107640	-6.47091152902358	8.62752719611771
C	-9.14683509908045	-6.36143457642242	7.40518736220136
C	-7.87791780958511	-5.69707352384506	7.41591381362574
C	-7.39578327887012	-5.16641283205119	8.64653273691916
C	-6.77610183978670	-3.87284210720524	8.64267260639424
C	-6.70890778376969	-3.14891111009690	9.87259157875843
C	-6.96686003515591	-1.75204733271096	9.86132524049504
C	-7.29782387358682	-1.10944814331613	11.10056773206003
C	-8.33431878235780	-0.11324672341455	11.09358294458409

C	-8.98264166168592	0.18335225937933	9.84653850871781
C	-10.38828223076149	0.38652565741856	9.84847632203304
C	-11.09416867872461	0.27133396323837	11.09313092375423
C	-12.36236803945776	-0.40591424807562	11.09426263229269
C	-12.85563979076743	-0.92191349575729	9.84862699196444
C	-13.47540735823032	-2.19969239463630	9.83993257945158
C	-13.58255713241055	-2.91131140863519	11.08059401290745
C	-13.33081280033221	-4.32644195104491	11.07536849157275
C	-12.97241936068948	-4.94647753412276	9.82801843776508
C	-11.94421414376118	-5.93086537340459	9.83754024935332
C	-11.31811906172742	-6.25432194484485	11.08875184037675
C	-9.89483944546336	-6.45167374213456	11.10510448756890
C	-9.17807041058396	-6.32756402614222	9.86869519017693
C	-7.92143307255086	-5.66397885482701	9.87889368157229
C	-7.43396411940950	-5.14492353781289	11.12419638754747
C	-6.80567413192398	-3.85195007865108	11.12102069763006
C	-6.67290811130444	-3.14094733126393	12.34360054551476
C	-6.92220789027429	-1.71261719094510	12.33221537304752
C	-7.24344572226210	-0.99207718517519	13.52616002085952
C	-8.23426206762386	-0.03875334930289	13.51933576370666
C	-8.95917889023667	0.24564361690121	12.31819105498684
C	-10.39643779614923	0.43970940291558	12.31944237531495
C	-11.17051159910432	0.34342631282192	13.51945537128972
C	-12.38260467108590	-0.30699375817845	13.51912813438011

C	-12.88987537284264	-0.89631524616459	12.31752730162446
C	-13.52956404240533	-2.19916574038163	12.31010176287794
C	-13.69504292468780	-2.96736914270297	13.50484124705424
C	-13.46196754119124	-4.32320095215701	13.49977151438620
C	-13.04434196722719	-4.98332432113991	12.30084000205048
C	-11.99609985103267	-5.98849262034641	12.30906991948953
C	-11.32782408933325	-6.37006900760035	13.51379295549213
C	-9.96335972692050	-6.55222503806375	13.52942548546775
C	-9.19360922694669	-6.36568373013681	12.33926568453695
C	-7.91373353134163	-5.68257117884057	12.34932283140409
C	-7.35045390335289	-5.14684852729061	13.55060880215557
C	-6.74522860681363	-3.91162368360340	13.54786737352273
H	-6.31492099674817	-3.68443244075690	-0.91327217637128
H	-6.86804126330723	-1.31233101021327	-0.94049264261073
H	-8.50377365605594	0.14628300783485	-0.96365955174848
H	-10.91373652199454	0.51526468288307	-0.97495448856606
H	-13.06868124082348	-0.23306467148806	-0.98075541625419
H	-14.03905795316757	-2.49617510791713	-0.91626557077126
H	-13.23423454379198	-4.57396393176247	-0.97006882849269
H	-11.52537940810076	-6.30592300845494	-0.96300789010559
H	-9.40231981535167	-6.80957519539224	-0.92182930083613
H	-7.23111287592496	-5.70506839631971	-0.90361099735025
H	-6.81380234220467	-1.30078036763378	14.48089959389463
H	-8.56586998525506	0.38555785570243	14.46872372362201

H	-10.73561037762628	0.64690728978248	14.47342520429927
H	-12.87734535237360	-0.50159996124233	14.47239282616898
H	-13.85597654961697	-2.46287526231324	14.45934287627509
H	-13.44455119797293	-4.85893856780798	14.45051097780401
H	-11.86883572520950	-6.36418154301941	14.46172079385896
H	-9.46006629399670	-6.68593995218028	14.48869875306937
H	-7.53308391947665	-5.64250235665947	14.50581945432854
H	-6.46290403183735	-3.46052266055229	14.50078408041441
C	-14.58399714876420	0.11298722490148	2.49626444633333
O	-15.64517787284529	-0.40063684296369	2.74230086151561
O	-14.42191352047286	1.42309877008729	2.26791310356908
H	-15.29734110199368	1.84499794266730	2.34505842486712
Hg	-18.11435468924242	1.69991155327687	1.98448295547243

fCNTPAN

C	-6.45814795672313	-3.19646652090558	0.02065412185897
C	-6.78961376775796	-1.86851172476030	-0.02375942055011
C	-7.29851056953420	-1.20718565440429	1.14923872033270
C	-8.37392628094581	-0.27301056753518	1.09605437853001
C	-9.02734720972059	0.07576095919267	-0.14255524498271
C	-10.37626429350650	0.26355196796439	-0.18586287451522
C	-11.18404598902984	0.12638060524866	1.01065413907144
C	-12.48430616030833	-0.35768793622083	0.97152610456606
C	-13.07196455187110	-0.90715663539972	-0.24648331887214

C	-13.56184399808698	-2.17160542063968	-0.21331686628344
C	-13.48168848120145	-2.95267710171389	1.02799853041494
C	-13.12348292212126	-4.34610901444114	1.03457137657752
C	-12.73224897276394	-5.04071083969009	-0.15501406933454
C	-11.75670987765051	-6.00688207208663	-0.11046045036722
C	-11.10342723330673	-6.32806428270959	1.12420062061759
C	-9.68376881596976	-6.58063855433615	1.18467298473554
C	-8.85520412227288	-6.54185306377465	0.01292356135731
C	-7.64286861831010	-5.90183739670248	0.04376766668467
C	-7.19894865025931	-5.25913332328832	1.24929606520365
C	-6.61961305583889	-3.94411871200256	1.23896390156280
C	-6.63849264614304	-3.19496719539709	2.45206000692627
C	-6.97525071605750	-1.80487073072222	2.40991851856966
C	-7.37407912740792	-1.15990837557747	3.62192342947742
C	-8.43890248430613	-0.21393324706374	3.57166591801807
C	-9.07904827846971	0.03266165651990	2.30719502470594
C	-10.48244373232121	0.25277658313345	2.27281850998799
C	-11.21672658236863	0.20076940479930	3.50218382616270
C	-12.51585263632611	-0.35389587647468	3.51048692292540
C	-13.24616326373527	-0.73506586920958	2.22937499801197
C	-13.47848040208763	-2.25367836509511	2.23361184394621
C	-13.52392099783458	-2.94349854858773	3.47341695302206
C	-13.19094158522010	-4.32429021335729	3.49989574064761
C	-12.79543159595686	-4.95528985793891	2.27967298563515

C	-11.77436781238255	-5.96240217306786	2.32589174693709
C	-11.18766350171339	-6.27257231509044	3.59671751503574
C	-9.78373023947324	-6.49401513771748	3.65383903755427
C	-9.02918896868267	-6.40744819269261	2.43644049940850
C	-7.76171419454180	-5.73465865131442	2.47077800752183
C	-7.32635820414901	-5.17951202158332	3.71698478244894
C	-6.74673283154981	-3.87894009460305	3.70845559178429
C	-6.71106033919154	-3.13432375757446	4.92531224078383
C	-7.02383084544338	-1.73717296364703	4.88221993986020
C	-7.41627289700940	-1.08344186697684	6.08929913778290
C	-8.46863620199839	-0.11895448349257	6.03924684067660
C	-9.10096286890083	0.14251567582497	4.78052146905717
C	-10.51660030262174	0.35004253164616	4.74618803537745
C	-11.24313791765230	0.27501940390869	5.96965726676734
C	-12.50580623034050	-0.38480291497864	5.95735219633053
C	-13.01234854755049	-0.88153309437516	4.71877587839429
C	-13.57845116149363	-2.21849567685706	4.71131343102517
C	-13.66081480280959	-2.92704272050272	5.93315265053358
C	-13.33699870840416	-4.32909291894590	5.96096422319291
C	-12.91548735876192	-4.95578774929558	4.75490303715719
C	-11.88553269884738	-5.94955497605648	4.80263756614214
C	-11.28974506796868	-6.25293225927060	6.06277094701782
C	-9.87504830040635	-6.46001729062967	6.11872089925286
C	-9.11945324698920	-6.36172720516341	4.91171342658252

C	-7.85681899112800	-5.68464033071864	4.94431428387190
C	-7.41548208884133	-5.12536617158582	6.18037113816328
C	-6.82598599464582	-3.82266299971091	6.17198340604643
C	-6.78897762680988	-3.07789346397177	7.39317216198281
C	-7.08339785598980	-1.67595388479572	7.35239657392820
C	-7.46843644050008	-1.02284648525549	8.55786466521133
C	-8.51728758937014	-0.04574625824671	8.50907890741773
C	-9.13954551084331	0.23036088272101	7.25511987998277
C	-10.55777277702069	0.42755414907459	7.22104009191998
C	-11.29242332317504	0.32215465188702	8.43467388495222
C	-12.55283805211141	-0.36594527125096	8.41688140019837
C	-13.02047049115491	-0.90351731493255	7.18490254691871
C	-13.62152640582438	-2.20384702552571	7.17866870965065
C	-13.73151643085406	-2.90530398137006	8.40762114742626
C	-13.44130065061782	-4.31526269282114	8.43198592168551
C	-13.03250919118936	-4.94505515428373	7.21818306223035
C	-11.98710851334738	-5.92271535220697	7.26932669179405
C	-11.38566345160332	-6.21909789247226	8.52884942567105
C	-9.96503270107612	-6.41156762088551	8.58386789403681
C	-9.21189784643614	-6.30870878148192	7.37827085268984
C	-7.95397284229795	-5.62451174496774	7.41029588191700
C	-7.51059412400823	-5.06846388906578	8.64426454458502
C	-6.90997492201689	-3.76590478149514	8.63597280325852
C	-6.88384239818275	-3.02298074415279	9.85601426095742

C	-7.16137570617900	-1.63033169629725	9.81703701895887
C	-7.53320626096390	-0.97464423840893	11.03777300946752
C	-8.58390653729334	0.00532491173602	10.98965761803785
C	-9.20411717720894	0.27411908825450	9.72226188926747
C	-10.61241466868486	0.45526661246145	9.68551783065550
C	-11.34835388059711	0.34747259064021	10.91343249401850
C	-12.60629550293615	-0.34868423722780	10.89297391038717
C	-13.05958964763876	-0.89129000508300	9.64323607321408
C	-13.66015871724562	-2.17885026580929	9.63901044897662
C	-13.78887983054306	-2.87280692277993	10.88772761598137
C	-13.51635940005136	-4.28402919006788	10.91099729202224
C	-13.11798993270835	-4.91828097419585	9.68300565363856
C	-12.07553925432514	-5.88643286092206	9.73348959638935
C	-11.47594386933872	-6.18027418362623	11.00478986500752
C	-10.05071586088008	-6.35526877511244	11.05950046521210
C	-9.30523217334017	-6.23867682047861	9.83946881461895
C	-8.05935576963437	-5.55563074570537	9.87062720190253
C	-7.61096439493627	-5.01074418893479	11.11957791763538
C	-7.00176334390318	-3.70870545302574	11.11223559572987
C	-6.91004895519117	-2.97779865703654	12.32682138761306
C	-7.18023451093582	-1.55376298032140	12.28752023513826
C	-7.54239478351511	-0.82071565450670	13.46194264872798
C	-8.54702778304072	0.11698372816166	13.41575353570098
C	-9.24508449193015	0.37264468055247	12.19253928236159

C	-10.68473726699777	0.54436145101657	12.15432890631987
C	-11.48784533879418	0.45456292384591	13.33556950660609
C	-12.69013021114956	-0.21353058645159	13.31469439730804
C	-13.15804388940138	-0.82834936160514	12.10991198541349
C	-13.77796258321738	-2.14090474711803	12.10674936389735
C	-13.96201852048206	-2.89321342314990	13.30888993803715
C	-13.70826202376429	-4.24519141139128	13.33095810922768
C	-13.25071585037065	-4.91733981894373	12.15349128357184
C	-12.18823335039205	-5.90620519151208	12.20362571096398
C	-11.54476138301053	-6.25896865784341	13.43039524488962
C	-10.17854024841301	-6.42007566767214	13.48264784918324
C	-9.38205746721700	-6.23984637428030	12.30924687706564
C	-8.11305802049659	-5.53738002773760	12.34055905250572
C	-7.58781799892625	-4.97553831119279	13.54711153143998
C	-7.00097065078185	-3.73148692979911	13.54049237226921
H	-6.21237800264558	-3.71590930721233	-0.90747430925232
H	-6.79864460729203	-1.35296146038201	-0.98567668389412
H	-8.45612649982919	0.07755041784002	-1.07272554653973
H	-10.86921741239088	0.41484816688390	-1.14762668647616
H	-13.01917078671910	-0.36072265536804	-1.19194976219613
H	-13.94433964883525	-2.64125665852421	-1.12171050698658
H	-13.10881434988347	-4.71052532956614	-1.12450720133083
H	-11.37690932246601	-6.41802131568519	-1.04720869913203
H	-9.24880964231085	-6.88892583501374	-0.94425160049169

H	-7.09627211915798	-5.74977986671707	-0.88873689034930
H	-7.13260970359394	-1.10871143985123	14.43175239249371
H	-8.90908380560042	0.54994300496265	14.34999686837477
H	-11.08193400474431	0.77889454660077	14.29543125888259
H	-13.20574055321597	-0.40149022096883	14.25817611704998
H	-14.15444102285116	-2.37678643276881	14.25109253763140
H	-13.70636393804686	-4.76574914263555	14.29025033845447
H	-12.10935410604129	-6.24706503670379	14.36441323770594
H	-9.69750750722769	-6.53131876181916	14.45610100811760
H	-7.78653197689442	-5.45986623952547	14.50491404802560
H	-6.74922287646063	-3.26203531421132	14.49311397955014
C	-14.60134071051298	0.01238632171242	2.30874820319158
O	-15.63304196106656	-0.51998321869402	2.64533074549383
O	-14.47042083982467	1.31222235774709	2.06289788614376
H	-15.26437054034064	1.76291226882255	2.41096540467031
H	-16.07182772194803	-0.86029066267233	6.04747377947384
C	-16.26298355872493	1.04902083537038	5.17884495371406
C	-16.31702129549941	0.16049839932825	6.38438758892395
N	-18.02325693844152	0.70332670578633	2.35866637322445
O	-18.49886507877111	-0.27733917593896	2.80520321235214
O	-17.51665084501700	1.73734316688041	3.36873395333941
O	-17.53987400502896	1.13252077343326	4.63308039813120
O	-17.87400162316948	1.14066291963805	1.26559700299820
O	-15.31436330349688	1.61170476577814	4.72082600074492

H	-17.31613008419308	0.14626212731465	6.83891964951403
H	-15.55379730797459	0.47852260087237	7.10516031131557

fCNTO₃

C	-6.53779000000000	-3.17182000000000	0.02619000000000
C	-6.85164000000000	-1.83909000000000	0.01085000000000
C	-7.32226000000000	-1.18994000000000	1.20676000000000
C	-8.38514000000000	-0.24100000000000	1.19575000000000
C	-9.06329000000000	0.13725000000000	-0.02089000000000
C	-10.40976000000000	0.34332000000000	-0.02752000000000
C	-11.18945000000000	0.19752000000000	1.18699000000000
C	-12.49572000000000	-0.26737000000000	1.17254000000000
C	-13.12057000000000	-0.78934000000000	-0.03920000000000
C	-13.63303000000000	-2.04448000000000	-0.01032000000000
C	-13.53405000000000	-2.84266000000000	1.21875000000000
C	-13.19333000000000	-4.24009000000000	1.19505000000000
C	-12.84301000000000	-4.92176000000000	-0.01469000000000
C	-11.88017000000000	-5.90160000000000	-0.01058000000000
C	-11.19943000000000	-6.25083000000000	1.20139000000000
C	-9.78288000000000	-6.52576000000000	1.22094000000000
C	-8.98423000000000	-6.48070000000000	0.02872000000000
C	-7.76171000000000	-5.85978000000000	0.03796000000000
C	-7.27715000000000	-5.24294000000000	1.24150000000000
C	-6.67888000000000	-3.93669000000000	1.23659000000000

C	-6.65609000000000	-3.20664000000000	2.46126000000000
C	-6.97493000000000	-1.81179000000000	2.44931000000000
C	-7.33462000000000	-1.18099000000000	3.68049000000000
C	-8.38810000000000	-0.22084000000000	3.67210000000000
C	-9.05632000000000	0.05460000000000	2.42887000000000
C	-10.45660000000000	0.29680000000000	2.43381000000000
C	-11.16276000000000	0.23876000000000	3.67931000000000
C	-12.47623000000000	-0.28669000000000	3.71242000000000
C	-13.23988000000000	-0.64410000000000	2.44343000000000
C	-13.49093000000000	-2.16108000000000	2.43381000000000
C	-13.51095000000000	-2.86836000000000	3.66437000000000
C	-13.19478000000000	-4.25373000000000	3.66092000000000
C	-12.84028000000000	-4.87169000000000	2.42175000000000
C	-11.83328000000000	-5.89391000000000	2.42571000000000
C	-11.21885000000000	-6.23273000000000	3.67569000000000
C	-9.81764000000000	-6.47715000000000	3.69293000000000
C	-9.09352000000000	-6.38274000000000	2.45783000000000
C	-7.81524000000000	-5.72989000000000	2.46976000000000
C	-7.33969000000000	-5.20115000000000	3.71270000000000
C	-6.74175000000000	-3.90884000000000	3.70922000000000
C	-6.66505000000000	-3.18386000000000	4.93599000000000
C	-6.96043000000000	-1.78252000000000	4.92226000000000
C	-7.31344000000000	-1.14246000000000	6.14859000000000
C	-8.35391000000000	-0.16399000000000	6.14016000000000

C	-9.01512000000000	0.12497000000000	4.90223000000000
C	-10.42781000000000	0.35487000000000	4.90714000000000
C	-11.12318000000000	0.27329000000000	6.14861000000000
C	-12.39794000000000	-0.36314000000000	6.15958000000000
C	-12.94674000000000	-0.83006000000000	4.92555000000000
C	-13.52621000000000	-2.16194000000000	4.91331000000000
C	-13.58442000000000	-2.88834000000000	6.12583000000000
C	-13.27699000000000	-4.29396000000000	6.12389000000000
C	-12.89560000000000	-4.90797000000000	4.89817000000000
C	-11.88028000000000	-5.91778000000000	4.90393000000000
C	-11.25746000000000	-6.25051000000000	6.14327000000000
C	-9.84539000000000	-6.48076000000000	6.15956000000000
C	-9.11935000000000	-6.37507000000000	4.93507000000000
C	-7.84602000000000	-5.71777000000000	4.94551000000000
C	-7.36509000000000	-5.18429000000000	6.17832000000000
C	-6.75748000000000	-3.88997000000000	6.17466000000000
C	-6.67915000000000	-3.16461000000000	7.40546000000000
C	-6.95575000000000	-1.75844000000000	7.39343000000000
C	-7.30077000000000	-1.11876000000000	8.61791000000000
C	-8.33637000000000	-0.12658000000000	8.61087000000000
C	-8.98744000000000	0.17672000000000	7.37793000000000
C	-10.40280000000000	0.39627000000000	7.38376000000000
C	-11.10704000000000	0.28259000000000	8.61451000000000
C	-12.37819000000000	-0.38492000000000	8.61932000000000

C	-12.88895000000000	-0.89372000000000	7.39233000000000
C	-13.50671000000000	-2.18580000000000	7.38109000000000
C	-13.59199000000000	-2.90592000000000	8.60111000000000
C	-13.31906000000000	-4.31939000000000	8.59629000000000
C	-12.95016000000000	-4.93502000000000	7.36294000000000
C	-11.91871000000000	-5.92865000000000	7.37210000000000
C	-11.29035000000000	-6.25484000000000	8.61086000000000
C	-9.87197000000000	-6.46981000000000	8.62649000000000
C	-9.14802000000000	-6.35973000000000	7.40377000000000
C	-7.87946000000000	-5.69468000000000	7.41394000000000
C	-7.39699000000000	-5.16392000000000	8.64440000000000
C	-6.77819000000000	-3.86997000000000	8.64043000000000
C	-6.71076000000000	-3.14619000000000	9.87044000000000
C	-6.96962000000000	-1.74949000000000	9.85955000000000
C	-7.30025000000000	-1.10730000000000	11.09908000000000
C	-8.33735000000000	-0.11171000000000	11.09286000000000
C	-8.98658000000000	0.18471000000000	9.84625000000000
C	-10.39234000000000	0.38708000000000	9.84905000000000
C	-11.09743000000000	0.27123000000000	11.09409000000000
C	-12.36522000000000	-0.40680000000000	11.09582000000000
C	-12.85890000000000	-0.92284000000000	9.85038000000000
C	-13.47786000000000	-2.20101000000000	9.84177000000000
C	-13.58383000000000	-2.91295000000000	11.08234000000000
C	-13.33123000000000	-4.32793000000000	11.07666000000000

C	-12.97315000000000	-4.94748000000000	9.82899000000000
C	-11.94434000000000	-5.93124000000000	9.83774000000000
C	-11.31738000000000	-6.25460000000000	11.08854000000000
C	-9.89397000000000	-6.45111000000000	11.10408000000000
C	-9.17795000000000	-6.32634000000000	9.86732000000000
C	-7.92169000000000	-5.66202000000000	9.87697000000000
C	-7.43388000000000	-5.14288000000000	11.12209000000000
C	-6.80639000000000	-3.84951000000000	11.11879000000000
C	-6.67342000000000	-3.13862000000000	12.34143000000000
C	-6.92358000000000	-1.71047000000000	12.33042000000000
C	-7.24455000000000	-0.99030000000000	13.52468000000000
C	-8.23591000000000	-0.03756000000000	13.51859000000000
C	-8.96172000000000	0.24660000000000	12.31790000000000
C	-10.39907000000000	0.43978000000000	12.32004000000000
C	-11.17239000000000	0.34273000000000	13.52051000000000
C	-12.38409000000000	-0.30839000000000	13.52074000000000
C	-12.89169000000000	-0.89781000000000	12.31930000000000
C	-13.53058000000000	-2.20102000000000	12.31198000000000
C	-13.69490000000000	-2.96959000000000	13.50667000000000
C	-13.46106000000000	-4.32528000000000	13.50116000000000
C	-13.04368000000000	-4.98489000000000	12.30185000000000
C	-11.99485000000000	-5.98941000000000	12.30930000000000
C	-11.32567000000000	-6.37083000000000	13.51359000000000
C	-9.96111000000000	-6.55222000000000	13.52844000000000

C	-9.19211000000000	-6.36492000000000	12.33789000000000
C	-7.91268000000000	-5.68103000000000	12.34739000000000
C	-7.34910000000000	-5.14513000000000	13.54848000000000
C	-6.74459000000000	-3.90957000000000	13.54561000000000
H	-6.32225000000000	-3.67973000000000	-0.91576000000000
H	-6.87714000000000	-1.30801000000000	-0.94229000000000
H	-8.51454000000000	0.14780000000000	-0.96446000000000
H	-10.92444000000000	0.51707000000000	-0.97401000000000
H	-13.07907000000000	-0.23144000000000	-0.97859000000000
H	-14.04609000000000	-2.49593000000000	-0.91453000000000
H	-13.24073000000000	-4.57243000000000	-0.96890000000000
H	-11.53114000000000	-6.30364000000000	-0.96313000000000
H	-9.40772000000000	-6.80650000000000	-0.92318000000000
H	-7.23695000000000	-5.70108000000000	-0.90592000000000
H	-6.81409000000000	-1.29885000000000	14.47911000000000
H	-8.56726000000000	0.38636000000000	14.46825000000000
H	-10.73721000000000	0.64649000000000	14.47426000000000
H	-12.87804000000000	-0.50372000000000	14.47427000000000
H	-13.85579000000000	-2.46542000000000	14.46135000000000
H	-13.44266000000000	-4.86119000000000	14.45179000000000
H	-11.86622000000000	-6.36569000000000	14.46179000000000
H	-9.45719000000000	-6.68564000000000	14.48743000000000
H	-7.53075000000000	-5.64115000000000	14.50369000000000
H	-6.46218000000000	-3.45838000000000	14.49847000000000

C	-14.59335000000000	0.11274000000000	2.50661000000000
O	-15.65144000000000	-0.38749000000000	2.78043000000000
O	-14.43272000000000	1.42275000000000	2.25448000000000
H	-15.30623000000000	1.83952000000000	2.35357000000000
O	-17.84849000000000	2.59072000000000	3.10904000000000
O	-18.53157000000000	1.81285000000000	2.45425000000000
O	-18.29925000000000	0.56418000000000	2.70027000000000

fCNTNO

C	-6.60915767488354	-3.08317985381730	0.01855013530897
C	-7.00449485650371	-1.77894783572451	0.01042065627962
C	-7.51369572706250	-1.16628640421608	1.21891218133171
C	-8.61545938826857	-0.28197487977439	1.22463095960455
C	-9.31624647498250	0.10941160424674	0.01506978306273
C	-10.65107644343319	0.35314213819554	0.02615827085974
C	-11.43454087327120	0.22521424664382	1.24868842205839
C	-12.75888865101541	-0.13878153546007	1.22640027388489
C	-13.34481198044932	-0.68112038771098	-0.01206818727591
C	-13.70209486585107	-1.98048717340194	0.00472819747337
C	-13.52632176984525	-2.76239001607362	1.23686037201100
C	-13.12287377579808	-4.12993952558880	1.20381081951662
C	-12.77155604318965	-4.80520858894143	-0.01930383701452
C	-11.82062373585189	-5.78716492666051	-0.02624456664728
C	-11.13828944944499	-6.15553173922572	1.18852785452368

C	-9.74249758232703	-6.45987416775655	1.20563578680295
C	-8.93586864991854	-6.42865211669503	0.00627914561235
C	-7.72021272116972	-5.81067941089444	0.01938030989106
C	-7.25025619302704	-5.17993414380644	1.23350293227304
C	-6.71010394326451	-3.86374108388113	1.23373114073803
C	-6.70237543014975	-3.13899413887162	2.46508026144816
C	-7.10462462019074	-1.76306701151827	2.46100232542470
C	-7.48450244596812	-1.15997326295803	3.69131728383141
C	-8.58954620644026	-0.25679866757853	3.69516354375864
C	-9.26622956874112	0.00158270957863	2.46820179994161
C	-10.67683008299555	0.24750618449302	2.50064291994615
C	-11.33581267812441	0.23559469292639	3.72791502935372
C	-12.84193316625823	0.02180700707446	3.78550205793203
C	-13.50586621978657	-0.53410557813489	2.48741716141907
C	-13.54135474357517	-2.08534242154822	2.47289749302190
C	-13.50240398887186	-2.80307731154416	3.68056819854224
C	-13.13320534713064	-4.17325288249510	3.66585449697426
C	-12.77039740241333	-4.77427155200039	2.42528569016608
C	-11.77309259122454	-5.80727176262709	2.41875688662545
C	-11.16486894724237	-6.16577266229594	3.65920366855209
C	-9.77368186098618	-6.43789637248337	3.67544815977759
C	-9.04761691458246	-6.34980574926908	2.44652732018261
C	-7.76746990024073	-5.69522609145374	2.46337411741535
C	-7.30672892098773	-5.15944714069378	3.70350841760746

C	-6.75595295290292	-3.84851784936808	3.70541644029073
C	-6.72085908920078	-3.12164664802489	4.94188900315918
C	-7.08594465743920	-1.75194329532005	4.93436319821519
C	-7.45495650117926	-1.12087101398066	6.16998705215470
C	-8.52767907502631	-0.17965336869642	6.17289405893974
C	-9.21739328194162	0.07281683332823	4.93579819108531
C	-10.61424658814176	0.31706466855420	4.95034811886447
C	-11.30536839561350	0.32063539763776	6.22283215384378
C	-12.60324234418704	-0.29035862593658	6.25176638094593
C	-13.13763190529922	-0.77795148697721	5.01891370579315
C	-13.52380699639542	-2.11086448490367	4.96177190761656
C	-13.58652683160151	-2.88346835214834	6.17651694550487
C	-13.23659622319065	-4.26721410160225	6.14692371534277
C	-12.82284627471263	-4.84467466753042	4.89986155218132
C	-11.82411918020718	-5.84329394523646	4.89692672789936
C	-11.21385368329484	-6.21919172785835	6.14008136244139
C	-9.80490690873122	-6.45940585957120	6.15526498129013
C	-9.07405440964184	-6.33768818586853	4.92675867568255
C	-7.81859430372280	-5.68214941452813	4.94134615466946
C	-7.33873273798639	-5.14965982115858	6.18341433935129
C	-6.77298827688103	-3.83741938919891	6.18443483993297
C	-6.72352598797409	-3.11299263825455	7.41088964816346
C	-7.06203168340459	-1.71814761782441	7.40403061054142
C	-7.43339642230973	-1.09463317422230	8.63429692345009

C	-8.48211014685537	-0.13459535111064	8.63595172813635
C	-9.14442856068235	0.17173929702504	7.40868791851786
C	-10.56649714085766	0.41449809669421	7.42629589991200
C	-11.25040560545842	0.27270000557714	8.68203397042284
C	-12.49316428817673	-0.40220105913817	8.69920312356720
C	-13.03442091068848	-0.88100738480536	7.46654723207012
C	-13.57528281734642	-2.20740836826467	7.43017397121704
C	-13.61604560357661	-2.95780284602051	8.64720019372988
C	-13.29374053482838	-4.33778753024947	8.61715976712599
C	-12.91868885001049	-4.93312721588342	7.36852806808288
C	-11.87820165136305	-5.92002244617875	7.36559392755951
C	-11.24324084693007	-6.25054353615699	8.60552197908957
C	-9.83905257281176	-6.45669865031723	8.62016037858309
C	-9.10924460724543	-6.34953772180859	7.39485341825519
C	-7.84544387142153	-5.67290014453525	7.40971643105484
C	-7.38536173554860	-5.12401825047583	8.64655405793387
C	-6.81291601376923	-3.82451451870845	8.64667795936023
C	-6.75986687823528	-3.09851542322779	9.88600384289172
C	-7.06202099115055	-1.71404680567402	9.87977221862042
C	-7.38818547676726	-1.07877643689659	11.11898923921301
C	-8.44503953446084	-0.09836220325577	11.12469767070394
C	-9.11464704267479	0.18543661263575	9.89440252786098
C	-10.51786932032385	0.37692814363810	9.91585567455906
C	-11.20796863108992	0.24195084695288	11.16267066609251

C	-12.46428261278794	-0.46259916951763	11.17253099434424
C	-12.95801497914980	-0.97135679826294	9.93415502963615
C	-13.53869350955909	-2.26345982968482	9.90802232480044
C	-13.61983532996068	-2.99549493206792	11.13126421357645
C	-13.32899723032852	-4.40588974816856	11.10229804811748
C	-12.94782478438064	-4.99214841722807	9.85258926660488
C	-11.90810418221226	-5.95560608486330	9.84645761604472
C	-11.28080809399840	-6.29604048752122	11.08745429937296
C	-9.85227854021066	-6.47434971946793	11.10105740841136
C	-9.14052616418330	-6.32620726915818	9.87054871610393
C	-7.89832623335833	-5.64385310818923	9.88426875169674
C	-7.42045768165347	-5.12010717352410	11.12600193754120
C	-6.82628958136038	-3.80851654609980	11.12642048053615
C	-6.72390087251822	-3.09451028892207	12.35309000004181
C	-7.00042904965137	-1.68605556493173	12.34658574400545
C	-7.31350049234720	-0.96533701974563	13.55603633143127
C	-8.31623840923906	-0.03767178342835	13.56374094768396
C	-9.07009662013617	0.22950813177227	12.36357957521457
C	-10.49355599531084	0.39029242630263	12.38485995316933
C	-11.25744737330327	0.26901743320350	13.60347680219387
C	-12.44571947761673	-0.40675432492219	13.61072594579419
C	-12.95288008795222	-0.99967473439406	12.39773982146978
C	-13.55466760921461	-2.30037570328908	12.37496827359687
C	-13.70904397042985	-3.09446948808561	13.56810134629998

C	-13.45133495809723	-4.43636396308756	13.54094416646437
C	-13.01145514520201	-5.06895880769875	12.32173323655579
C	-11.95609488232282	-6.04010527914508	12.31473627643688
C	-11.27883707473975	-6.43596657274775	13.52369840840037
C	-9.91980644129409	-6.58959818462221	13.53572699391223
C	-9.15214436567969	-6.36815737253153	12.33749360606699
C	-7.90175976158807	-5.66271734338865	12.35137881616429
C	-7.34395853988480	-5.11807716461591	13.56295109857301
C	-6.77159669105970	-3.87533023322598	13.56343280815470
H	-6.34527899957144	-3.57306120488702	-0.92068277402961
H	-7.04915612457572	-1.23477912318501	-0.93473393979217
H	-8.77540830013332	0.13017674046586	-0.93284435958317
H	-11.16866589459259	0.56911609613367	-0.90956965619777
H	-13.41437503871547	-0.08091060601555	-0.92231681756529
H	-14.08303214628368	-2.46867897471301	-0.89423444004716
H	-13.18133844996325	-4.45382165711094	-0.96723013184136
H	-11.48408220158000	-6.19688563481227	-0.98003164295987
H	-9.35193653617927	-6.78135213209596	-0.93946640560717
H	-7.17379694287687	-5.67041955672043	-0.91527328811076
H	-6.83949242793912	-1.25108796677806	14.49681742993807
H	-8.63001681121935	0.40464546523469	14.51103719381907
H	-10.82400462318201	0.59696822253620	14.54994537766281
H	-12.94114844155910	-0.60728380157557	14.56249479467347
H	-13.90571087268838	-2.60558780888310	14.52410454230555

H	-13.44734549849301	-4.99907455395242	14.47611816520724
H	-11.82904188325663	-6.47797411989710	14.46530403515449
H	-9.40841275700634	-6.75024205410770	14.48665893060669
H	-7.49818756342054	-5.63474100119163	14.51201797282201
H	-6.47836107927757	-3.42395693548381	14.51288032960269
C	-14.99696023613640	-0.08975158367033	2.52709136959128
O	-15.67986471743099	-0.20659782370632	3.51323128458472
O	-15.48401779233832	0.33657798901594	1.35372702707138
H	-16.42526082195095	0.53145813025016	1.50751545773175
N	-13.25782366701316	1.50982791874852	4.05704422960954
O	-13.83224325315598	2.03008056847623	3.15318004279974

fCNTPTFE

C	-6.75427832024757	-3.11259978663379	0.00225763861597
C	-7.05971352495102	-1.77783941359483	0.00887885066072
C	-7.49305588899184	-1.13804036239938	1.22380195159266
C	-8.55001653316314	-0.18295678125474	1.25175067982928
C	-9.25947391112028	0.21010071195031	0.05775937780540
C	-10.60457839516678	0.42180815882949	0.09046748857601
C	-11.34975955220112	0.26816059099521	1.32536799215745
C	-12.65668825761326	-0.19169962027918	1.34287809910442
C	-13.32304974929277	-0.69531587011663	0.14575936053451
C	-13.84707499315575	-1.94574185829584	0.17866758106712
C	-13.71347860023928	-2.75769509837257	1.39525657878696

C	-13.38274102204933	-4.15675747707993	1.34799565267702
C	-13.07084469404713	-4.82730615722323	0.12182890923962
C	-12.11333154963504	-5.81197244255835	0.08888635859500
C	-11.40083707829562	-6.17771523714672	1.27760536230867
C	-9.98567782533758	-6.46013552133307	1.25453398937158
C	-9.22066911098395	-6.40715960721665	0.04083733884916
C	-7.99474994214752	-5.79311468763449	0.02180649463923
C	-7.47295950824274	-5.19127033582067	1.21726732555343
C	-6.86670708320903	-3.88871011880885	1.20846841545016
C	-6.80509892224195	-3.17119025291956	2.43917247963228
C	-7.11520121230901	-1.77440934236451	2.44996904335492
C	-7.43656908805051	-1.15388013280607	3.69683473911098
C	-8.48406569215463	-0.18758437133729	3.72738035061896
C	-9.18493419582340	0.10397957057091	2.50611050315421
C	-10.58303189330541	0.35357979391219	2.55273993236531
C	-11.25528305328621	0.28839367640015	3.81663886680511
C	-12.57158798207392	-0.22848651186796	3.88181644058584
C	-13.36815144136773	-0.57450332334818	2.63139944713537
C	-13.62648578879217	-2.08936488606297	2.61492591073834
C	-13.61780602165706	-2.80742343284101	3.83869423617275
C	-13.31278209409257	-4.19490459411580	3.81273570855017
C	-12.99844251930570	-4.80269442827902	2.55783434025923
C	-11.99776051651431	-5.83035821972584	2.52308226228030
C	-11.35018066232863	-6.18508973934973	3.75190380440473

C	-9.95034061312895	-6.43675177355030	3.72712310497631
C	-9.26095932305206	-6.33339604358585	2.47292663543795
C	-7.97922652218704	-5.68756465638548	2.45529651162122
C	-7.46561763655126	-5.17419410287046	3.68954909732270
C	-6.86013494862793	-3.88541177387087	3.68200575138153
C	-6.74458304793090	-3.17323449519239	4.91315818587992
C	-7.03170874918071	-1.77008103806299	4.92152407271401
C	-7.34653493650052	-1.14032834700701	6.16341335614229
C	-8.38092261156648	-0.15588483849239	6.19373605136537
C	-9.07476481424439	0.14931489195295	4.97773639829608
C	-10.48543424559887	0.38774306525517	5.02443076132748
C	-11.14611126806633	0.29782804460802	6.28424659496096
C	-12.42390928287072	-0.33122309033532	6.32501768000328
C	-13.01016624029564	-0.78240279793558	5.10219823650176
C	-13.59560303629634	-2.11222294690504	5.09357007285598
C	-13.62418450141193	-2.85025873853191	6.30024636501022
C	-13.32554459332680	-4.25761969482655	6.27612842461742
C	-12.98316472895995	-4.86268933083740	5.03454135447971
C	-11.97463719311283	-5.87883797754649	5.00155502391639
C	-11.31890896959020	-6.22677765322784	6.21949089796405
C	-9.90831257717992	-6.46489467741614	6.19355185723028
C	-9.21670333606187	-6.35081692805020	4.94999798219472
C	-7.93984923462464	-5.70042865567502	4.93097576267223
C	-7.42125231732203	-5.18197497847071	6.15492221837862

C	-6.80641946171110	-3.89112098088916	6.14688052368464
C	-6.68914086524096	-3.17846561608729	7.38204436414178
C	-6.95771067276825	-1.77071876350457	7.39156917207853
C	-7.26425162507404	-1.14123762515282	8.63138364011558
C	-8.29357148336385	-0.14293380884438	8.66312275666993
C	-8.97723819210267	0.17634256122816	7.45207372947685
C	-10.39048892752639	0.40423771058084	7.49981546907559
C	-11.06040519910515	0.28236060041222	8.74876679192596
C	-12.33483660958689	-0.37807041743136	8.78290075539639
C	-12.88287500750937	-0.87171918119098	7.56585607304675
C	-13.50775570652036	-2.16051083601799	7.55958196424360
C	-13.56284187510777	-2.89220759002962	8.77440943496255
C	-13.29839118428722	-4.30712944164943	8.74826667400288
C	-12.96805232037554	-4.91274412369041	7.49923663523750
C	-11.94319697683246	-5.91279654996328	7.46960082074899
C	-11.28220198618679	-6.25474152397955	8.68686434955895
C	-9.86520244634279	-6.47811586572527	8.66030253673062
C	-9.17544468490442	-6.35993821682544	7.41873733661938
C	-7.90336917637173	-5.70185940730264	7.39958923266770
C	-7.38330148505390	-5.18604378328960	8.62105956686111
C	-6.75737657945361	-3.89546304719296	8.61230567842982
C	-6.65117551536656	-3.18428747292932	9.84690972493956
C	-6.90206073644933	-1.78611394175775	9.85694611004373
C	-7.19380468996431	-1.15430722302643	11.11149885959754

C	-8.22458060592331	-0.15268961052410	11.14416178573970
C	-8.90679727822493	0.15989849147445	9.91927278012556
C	-10.31064544101152	0.37046797007471	9.96362365282757
C	-10.98109074734339	0.24629329161515	11.22687350597725
C	-12.25221123083702	-0.42470243213311	11.25773719996371
C	-12.78372112007637	-0.92562578190807	10.02170572725043
C	-13.40990454852910	-2.20027485804851	10.01816814792900
C	-13.48503181129671	-2.92387450399978	11.25425550002861
C	-13.24091514816936	-4.34007482873321	11.22776521665199
C	-12.92178647677496	-4.94931219589087	9.96454079510378
C	-11.89931958317515	-5.93924152210140	9.93473392009210
C	-11.23942278047710	-6.27860300310264	11.16417899992643
C	-9.81737778955606	-6.48357556798777	11.13761214209652
C	-9.13571627209207	-6.35068018057784	9.88236889810913
C	-7.87584030031549	-5.69345493520672	9.86303004201069
C	-7.35010551718319	-5.18936643651838	11.09892724376296
C	-6.71563927870474	-3.89940938983857	11.09056040188087
C	-6.54423857421816	-3.20139563478189	12.31580826161218
C	-6.78626303872075	-1.77175646711895	12.32579082791526
C	-7.06930750402284	-1.06172234406228	13.53556006965728
C	-8.05460769736692	-0.10315319148790	13.56665283242294
C	-8.81201326945551	0.19717250112915	12.38971775094791
C	-10.24757949443140	0.39876062342764	12.43422633501207
C	-10.98741279996613	0.29428287074390	13.65496605400681

C	-12.20245339600892	-0.35002899165546	13.68301068138852
C	-12.74688042071307	-0.92486235091872	12.49071551746539
C	-13.39321949748699	-2.22445517984023	12.48876286764911
C	-13.52833663175163	-3.00384394805527	13.68003979558574
C	-13.30272887723381	-4.36073974199160	13.65479983123764
C	-12.92310615454619	-5.01079241992589	12.43790504335744
C	-11.88066345692286	-6.02157161235200	12.40603859460977
C	-11.18018636531207	-6.41870735354590	13.58718617992638
C	-9.81684263433560	-6.60814999365949	13.56174894089431
C	-9.08058394437308	-6.41355501009464	12.35187985634282
C	-7.79731351477402	-5.73696161032586	12.33193623917997
C	-7.19724047195443	-5.21598497246173	13.52181449061579
C	-6.58597049319148	-3.98374518243979	13.51393616232764
H	-6.56809065655725	-3.61220603391919	-0.95033005556666
H	-7.10792270244617	-1.23699541839345	-0.93785833962567
H	-8.73711883382143	0.22671505053423	-0.90056490253972
H	-11.14615549566617	0.60500930335868	-0.83908628994561
H	-13.31588343720371	-0.12237064945137	-0.78436909968599
H	-14.30614104202285	-2.37751914449377	-0.71223718405782
H	-13.49276434955946	-4.46405990554217	-0.81671312762589
H	-11.79284941329875	-6.20520925898463	-0.87726894700736
H	-9.67263738755917	-6.72078769539591	-0.90200429754373
H	-7.49595318005482	-5.62765887546706	-0.93490049793645
H	-6.61421187808159	-1.38226286605089	14.47447308821492

H	-8.35662595274390	0.31315767416604	14.52936430730721
H	-10.52388882837559	0.58623533502605	14.59900437192323
H	-12.67059249547525	-0.55189806774672	14.64812969024799
H	-13.65933950180522	-2.50825196949487	14.64373683977290
H	-13.26079179746917	-4.90607675378729	14.59929579518946
H	-11.69373919137500	-6.41977794263662	14.55028401157164
H	-9.28695268603390	-6.75388062609954	14.50481034957240
H	-7.35487750965867	-5.72031637777744	14.47693364607927
H	-6.27440888998045	-3.54351995187394	14.46282220134648
C	-14.72115495660914	0.17775031733138	2.70380708939408
O	-15.78378653986591	-0.34351165237894	2.92687201515217
O	-14.57045559374671	1.49106661091761	2.48264785512051
H	-15.45639537445156	1.89428268664182	2.51799483653163
C	-16.46226881545447	0.44760434450560	-0.41161724918892
C	-17.27199155619711	0.65577106921676	0.62297740268550
F	-15.56636098792401	1.33064574104782	-0.80955557197500
F	-18.16829128665200	-0.19916480163796	1.04271589043580
F	-17.23791666203926	1.78072372513083	1.32489379660590
F	-16.46919407310258	-0.65466817457285	-1.13218802417556

fCNTSO₂

C	-6.47254408698568	-3.20158147677307	0.04043370953988
C	-6.78613504607369	-1.86904403703782	0.01862669427641
C	-7.26517579794861	-1.21617063275840	1.20940790038855
C	-8.32745219178466	-0.26738193355486	1.18808533694459
C	-8.99725850072420	0.10730299382259	-0.03459403453490
C	-10.34354707366571	0.31244033220696	-0.05129823454031
C	-11.13141237203383	0.16911223573271	1.15852421503686
C	-12.43622412079604	-0.29756648541149	1.13603283080590
C	-13.05480452764930	-0.82291629160436	-0.07755328127599
C	-13.56940445220522	-2.07714398965903	-0.04761520519733
C	-13.47744134134380	-2.87175483376028	1.18456452436023
C	-13.13664674270579	-4.26917654787693	1.16795144791105
C	-12.77804393729589	-4.95458623684587	-0.03724979422353
C	-11.81455233282321	-5.93363834745720	-0.02341114171600
C	-11.14156953620583	-6.27820942958464	1.19430051998362
C	-9.72519675701042	-6.55242210660577	1.22428780570688
C	-8.91862786717847	-6.51076567646132	0.03720101951718
C	-7.69647592738815	-5.88945519762002	0.05266775938108
C	-7.22035866556230	-5.26848290192439	1.25756764154803
C	-6.62204047229746	-3.96254247281676	1.25249068370415
C	-6.60724444865535	-3.22861656185965	2.47501195021844
C	-6.92573946926283	-1.83382102985609	2.45644841317139
C	-7.29359031615879	-1.19904121171919	3.68293244677368
C	-8.34708901378707	-0.23891419207353	3.66425418199671

C	-9.00696210254763	0.03232815140446	2.41574720399849
C	-10.40722575309541	0.27399077459814	2.41029067658229
C	-11.12159838999041	0.21962799923534	3.65069830195696
C	-12.43487456648740	-0.30749685893088	3.67715318591126
C	-13.18847795549932	-0.67028228118730	2.40311645236377
C	-13.44236973703593	-2.18655769384092	2.39782528643734
C	-13.47033372630128	-2.88936759979078	3.63068545204707
C	-13.15414324792993	-4.27464386580815	3.63396832763242
C	-12.79130426195879	-4.89641823551319	2.39914356791311
C	-11.78396273915239	-5.91808056052896	2.41327297947262
C	-11.17781289457295	-6.25253431861520	3.66840794201157
C	-9.77661345197657	-6.49614031061937	3.69585093768197
C	-9.04426205620649	-6.40522288219316	2.46537640373512
C	-7.76634865149641	-5.75192845713396	2.48384328694172
C	-7.29920015107166	-5.21921282581294	3.72813962163882
C	-6.70127362666766	-3.92686598938227	3.72452667532303
C	-6.63312254844858	-3.19794818812654	4.94944269683552
C	-6.92811193019613	-1.79670341393548	4.92918091415264
C	-7.28954615553912	-1.15280274657104	6.15108975160439
C	-8.33000943345814	-0.17459328244246	6.13240154488965
C	-8.98271116959116	0.11023536600862	4.88889816177285
C	-10.39544711481000	0.33939208370229	4.88331806683752
C	-11.09939034817201	0.26107156383078	6.12030497311373
C	-12.37400750628275	-0.37563635488673	6.12485505395335

C	-12.91418275525016	-0.84702564692464	4.88841768731882
C	-13.49464366428995	-2.17877879691578	4.87699340915850
C	-13.56061174615178	-2.90098929755897	6.09162879606115
C	-13.25305254381183	-4.30661731342026	6.09648803515919
C	-12.86296251559128	-4.92450733929118	4.87539204194060
C	-11.84762368385570	-5.93412501656732	4.89122020007992
C	-11.23294020041379	-6.26219788604469	6.13585364394538
C	-9.82094739825547	-6.49175405149646	6.16236536766473
C	-9.08680053767851	-6.38943213264858	4.94233184100404
C	-7.81371335289958	-5.73195800884581	4.95921692825095
C	-7.34122832237419	-5.19441269970039	6.19355296163580
C	-6.73369145576058	-3.90011847005943	6.18982472935688
C	-6.66360207197330	-3.17082559827067	7.41871608476028
C	-6.94024408190840	-1.76471581334892	7.40026171825455
C	-7.29388528210956	-1.12125110053953	8.62023220595218
C	-8.32953100886808	-0.12932274996546	8.60285640982459
C	-8.97213048467647	0.16987326974248	7.36453841390525
C	-10.38765006093374	0.38868727460989	7.35996078170279
C	-11.10025031654825	0.27870429603753	8.58616705866170
C	-12.37136372292509	-0.38881112008299	8.58464814509934
C	-12.87367106138468	-0.90188850452092	7.35595489673268
C	-13.49142698891229	-2.19415433327718	7.34504380814494
C	-13.58448825366422	-2.91023613014112	8.56681669394626
C	-13.31167560456137	-4.32377902502571	8.56857201715189

C	-12.93431760470842	-4.94335931534296	7.33981108620952
C	-11.90259769994735	-5.93658632290493	7.35913883405528
C	-11.28233331598672	-6.25817993767795	8.60314268919791
C	-9.86407929052204	-6.47286804178879	8.62896823302425
C	-9.13200894911735	-6.36646422908147	7.41077723229029
C	-7.86371876412995	-5.70100602710245	7.42731254305288
C	-7.38977862144313	-5.16606737327608	8.65925414137452
C	-6.77096609094045	-3.87216317539875	8.65526263581495
C	-6.71207147061140	-3.14438912136361	9.88337625115340
C	-6.97102973627118	-1.74782829048454	9.86618952748194
C	-7.31024366559611	-1.10166884037764	11.10126473809047
C	-8.34751708240073	-0.10640493392677	11.08468678510002
C	-8.98834965786246	0.18567538318195	9.83273856972897
C	-10.39406818180517	0.38775583741871	9.82529563648924
C	-11.10759972360788	0.27605081563422	11.06583764219490
C	-12.37520634071561	-0.40229985778630	11.06129823989255
C	-12.86022398615482	-0.92278772578964	9.81429289858106
C	-13.47891304552368	-2.20105523548816	9.80589113383285
C	-13.59319196168817	-2.90884665494434	11.04806726275907
C	-13.34024170901471	-4.32378377930349	11.04881283150188
C	-12.97364626832040	-4.94743764469313	9.80564726398157
C	-11.94470715241830	-5.93087881858218	9.82456969662647
C	-11.32609073904447	-6.24993631081038	11.08057412742816
C	-9.90278743375431	-6.44601805985023	11.10630053117267

C	-9.17850643754270	-6.32503413351927	9.87398539803699
C	-7.92252881185330	-5.66040512930207	9.88992936898382
C	-7.44319245454583	-5.13714785208785	11.13658183894270
C	-6.81600429532732	-3.84365327753950	11.13331821506350
C	-6.69163107851638	-3.12874459674322	12.35448441337098
C	-6.94195566946440	-1.70072013994727	12.33710425957309
C	-7.27128143846201	-0.97674501046097	13.52679464916725
C	-8.26263577249288	-0.02415232883688	13.51081460662787
C	-8.98032531653013	0.25572761233240	12.30421884894532
C	-10.41762546362989	0.44879268406298	12.29590267808279
C	-11.19903673444012	0.35561282737976	13.49143422428068
C	-12.41057076940698	-0.29572031841713	13.48570196981188
C	-12.90975322980148	-0.88941078997447	12.28279759111392
C	-13.54834528532315	-2.19276313746708	12.27559327117298
C	-13.72024818319613	-2.95736817452779	13.47177111277113
C	-13.48617743890472	-4.31300350559089	13.47235936785864
C	-13.06054875604947	-4.97646018544787	12.27803906410988
C	-12.01177151416049	-5.98089741163623	12.29585824590285
C	-11.35063113587055	-6.35811314232783	13.50588467367398
C	-9.98618471360304	-6.53920439482170	13.53048944846274
C	-9.20930762286103	-6.35549757464474	12.34449440592316
C	-7.93006807709506	-5.67140802718395	12.36036804064238
C	-7.37477650172155	-5.13144283690478	13.56350380127913
C	-6.77054712954051	-3.89577130435261	13.56071105046940

H	-6.25003274162101	-3.71252779935778	-0.89823086024759
H	-6.80461933637878	-1.34073032094994	-0.93619168823326
H	-8.44161062667797	0.11650425718457	-0.97411627022441
H	-10.85201139971488	0.48455407128331	-1.00140645625700
H	-13.00943793828944	-0.26661703957239	-1.01762845158899
H	-13.97967650198610	-2.53032054118212	-0.95217492290820
H	-13.16985794190706	-4.60869466416395	-0.99512795014531
H	-11.45908328701826	-6.33883184171238	-0.97221128358191
H	-9.33544235205770	-6.84025746053033	-0.91635245877339
H	-7.16533791776788	-5.73361648274143	-0.88809708172784
H	-6.84709508809182	-1.28187927211491	14.48510838665870
H	-8.60041604002105	0.40299727249554	14.45673378935888
H	-10.77043600729009	0.66282863513840	14.44705013063332
H	-12.91108798174976	-0.48767162022954	14.43647306991194
H	-13.88795756741306	-2.45010942231762	14.42362797605385
H	-13.47384446695362	-4.84570266903636	14.42487297345789
H	-11.89754280269284	-6.35009939222462	14.45039859496768
H	-9.48869285794522	-6.66959620151358	14.49322857166780
H	-7.56244750361431	-5.62458028188422	14.51903189408865
H	-6.49456022098266	-3.44143694443206	14.51393882895793
C	-14.53130265223396	0.10049326043130	2.45851898555255
O	-15.57930830336443	-0.43437391497176	2.77463010224979
O	-14.39285773762326	1.38262848176584	2.17385434139293
H	-15.26278721936371	1.84108307556825	2.27272371485918

S	-17.68910688799353	0.97863288477440	3.11514134008998
O	-18.65745068963730	0.36083981075092	2.21277891917357
O	-16.96235197685504	2.15483407953532	2.58353599901350

fCNTNH₃

C	-6.45542978697890	-3.22876118676497	0.03569591156991
C	-6.77962776077478	-1.89866942915164	0.00496207688637
C	-7.26665531310173	-1.24225842518074	1.19011932825905
C	-8.33698728003870	-0.30175942035116	1.15999770766982
C	-9.00616952177499	0.05979813923034	-0.06649656025779
C	-10.35433909736974	0.25423047240821	-0.08816414852613
C	-11.14467107130059	0.11253894646825	1.11977938129002
C	-12.44635538542050	-0.36556520828740	1.09719193304622
C	-13.05463745906677	-0.90413693413584	-0.11525668363747
C	-13.55831266621779	-2.16286560102653	-0.07952976728625
C	-13.46584421932994	-2.94866320983580	1.15784606441932
C	-13.11389999436096	-4.34367445644530	1.15048529182619
C	-12.74626286347148	-5.03371143617288	-0.04927933977085
C	-11.77504498857089	-6.00508067538414	-0.02676225069087
C	-11.10294420894678	-6.33701040332936	1.19478363361828
C	-9.68414178038115	-6.59911067975307	1.23041090489231
C	-8.87456033574565	-6.55803316488150	0.04557078905480
C	-7.65743858438197	-5.92653458530683	0.06071267830408
C	-7.18952306038605	-5.29476527784941	1.26296009092292

C	-6.60194497491802	-3.98348707342189	1.25163249113176
C	-6.59704527069010	-3.24203605080108	2.46959552042212
C	-6.92686478496040	-1.84996397348068	2.44159303655433
C	-7.30363186972932	-1.21080573755461	3.66345791729712
C	-8.36462206088630	-0.25937852382196	3.63595028775971
C	-9.02272404561844	-0.00071705666642	2.38368588962986
C	-10.42506946206560	0.22916406872241	2.37263477967728
C	-11.14279211746285	0.17618197971356	3.61192489349820
C	-12.45113608201999	-0.36171593234778	3.63700461282091
C	-13.19948546907086	-0.73680756500386	2.36448795263971
C	-13.43926710515562	-2.25524477172061	2.36660382808313
C	-13.46573229131852	-2.95140641732700	3.60346017460698
C	-13.13865599794496	-4.33422057944797	3.61616676534622
C	-12.76730930843139	-4.96086096156563	2.38631830623527
C	-11.75152087957924	-5.97410525972772	2.40952940369967
C	-11.14614967845736	-6.29581715956858	3.66848773534750
C	-9.74309860156164	-6.52783354495527	3.70140577909036
C	-9.00795770464654	-6.43857153031248	2.47239867021654
C	-7.73545430584311	-5.77471234556877	2.49043501985840
C	-7.27627971936042	-5.23055345491894	3.73297359846381
C	-6.68905928353922	-3.93336671909783	3.72320915884226
C	-6.63004155030091	-3.19654764360760	4.94384240471633
C	-6.93665649814562	-1.79772413496367	4.91424733349779
C	-7.30688337883159	-1.14943079747545	6.13108497879096

C	-8.35515971739036	-0.17965797706957	6.10352684791072
C	-9.00638428412255	0.09261121355135	4.85669760961877
C	-10.42110435431456	0.31034648673253	4.84569280554299
C	-11.12794654798251	0.23399585778244	6.08093525620551
C	-12.39722309355958	-0.41352488295756	6.08546595544450
C	-12.92966905566973	-0.89689053672076	4.85067622230231
C	-13.49842317036301	-2.23355136058794	4.84541919868774
C	-13.56254741646539	-2.94886960428813	6.06418512543788
C	-13.24387644989426	-4.35191819599310	6.07846253448581
C	-12.84588569852502	-4.97426205087944	4.86232378372682
C	-11.82202200064556	-5.97524459254876	4.88731973379838
C	-11.20827180134567	-6.29090607204175	6.13557877649715
C	-9.79450774278920	-6.50885157728440	6.16750429669531
C	-9.05767015290401	-6.40839322349660	4.94910959734114
C	-7.79000098192908	-5.74011310897855	4.96559762512852
C	-7.32546961776313	-5.19124421943727	6.19789439504421
C	-6.72870255976891	-3.89190176013277	6.18800388625458
C	-6.66833745732094	-3.15458977044478	7.41278784864158
C	-6.95637472787485	-1.75096127628871	7.38502546735823
C	-7.31851532727653	-1.10291007409550	8.60010964997070
C	-8.36226898735641	-0.11949156445607	8.57383890613394
C	-9.00370291821772	0.16698114257028	7.33193123699635
C	-10.42083441277290	0.37449869626403	7.32194412886519
C	-11.13615728373703	0.26641616468767	8.54678001885327

C	-12.40178939863173	-0.41183651350347	8.54551493424955
C	-12.89596143366020	-0.93658379935104	7.31845918604387
C	-13.50272709824758	-2.23391575828632	7.31342423431756
C	-13.59402237230080	-2.94323218835518	8.53934418490932
C	-13.30939225849287	-4.35444322788046	8.55047525874101
C	-12.92352311975229	-4.97847901393156	7.32662014754863
C	-11.88397656662609	-5.96324167393024	7.35500236462812
C	-11.26488936235867	-6.27253776378692	8.60269625252405
C	-9.84488662705357	-6.47534513693259	8.63389593113414
C	-9.11018348528026	-6.37039059088717	7.41719333756072
C	-7.84739924798121	-5.69456082289908	7.43329549248576
C	-7.38118729393854	-5.14853097507577	8.66332260683336
C	-6.77329434253733	-3.84931690977373	8.65322598450419
C	-6.72391113365953	-3.11369427236102	9.87698838922286
C	-6.99432494777627	-1.71936728550998	9.85061068767679
C	-7.34245112556816	-1.06861312741638	11.08091260007440
C	-8.38767375697224	-0.08191039269814	11.05541110985047
C	-9.02710067165417	0.19763314326887	9.79984017604755
C	-10.43448311322747	0.38824855693151	9.78711302166915
C	-11.15072297050176	0.27803312457300	11.02635225528563
C	-12.41283109728655	-0.41052165734202	11.02215468689016
C	-12.88996490086074	-0.94231943234830	9.77683205303962
C	-13.49792328970545	-2.22584053956097	9.77426842735240
C	-13.60996129518709	-2.92706610994745	11.02045375498150

C	-13.34540008869940	-4.33981346966920	11.03053989288663
C	-12.97011860819472	-4.96797299087689	9.79224234592028
C	-11.93328308185662	-5.94293766405767	9.82009789391689
C	-11.31574298191575	-6.24927842290745	11.07986483478112
C	-9.89100223876081	-6.43377609151525	11.11087739078530
C	-9.16412022716849	-6.31455479167956	9.87987407792673
C	-7.91357145245367	-5.63959953649395	9.89533892967964
C	-7.44223365801840	-5.10480000990426	11.14023488117496
C	-6.82570652015325	-3.80621750703399	11.13090209333999
C	-6.71047457515782	-3.08299894644160	12.34807497375068
C	-6.97262335858821	-1.65710104187392	12.32137010495217
C	-7.31128715063339	-0.92877536945222	13.50566355054103
C	-8.31050676676805	0.01551902768694	13.48112304096951
C	-9.02683420997456	0.28256400891367	12.27095296890468
C	-10.46578883596278	0.46380449696891	12.25735584963187
C	-11.24988340140162	0.37139272705740	13.45108548191535
C	-12.45615018879804	-0.28983690466194	13.44569213007148
C	-12.94715830167457	-0.89450274797582	12.24502674718881
C	-13.57490893012943	-2.20326969441209	12.24377634884101
C	-13.74424044734002	-2.96202201468357	13.44393911902467
C	-13.49880586154414	-4.31570022537482	13.45345709766598
C	-13.06430581648838	-4.98288915405943	12.26455646499362
C	-12.00717761359541	-5.97846923263346	12.29151030188762
C	-11.34657814560451	-6.34305359524842	13.50562984268148

C	-9.98071722394775	-6.51295586659008	13.53525170499171
C	-9.20183801076423	-6.33043997883674	12.35048752744639
C	-7.92819868314999	-5.63571365175503	12.36584860832434
C	-7.38078523191040	-5.08399346101441	13.56717265657364
C	-6.78673563999203	-3.84333347044800	13.55858280335072
H	-6.22712801085911	-3.74357784796188	-0.89946895954396
H	-6.80052008991302	-1.37680164594424	-0.95336765039632
H	-8.44831187673580	0.06606966233423	-1.00475074951620
H	-10.86104257373219	0.41477398945509	-1.04127980030271
H	-13.00638299645453	-0.35571773675424	-1.05991591643850
H	-13.95793726358052	-2.62605882329286	-0.98384432740637
H	-13.13764335942757	-4.69684566742407	-1.01057177061217
H	-11.41335589913008	-6.41277213909236	-0.97216737988855
H	-9.28615584632416	-6.89583905079326	-0.90735739222085
H	-7.12522668250952	-5.77186769606530	-0.87966284998249
H	-6.88773834209719	-1.22491579333101	14.46708327378717
H	-8.65476884033455	0.44506972616486	14.42362964851737
H	-10.82648054180461	0.68734528551864	14.40618057804061
H	-12.95753903671565	-0.48063153866538	14.39625442879574
H	-13.91857844780733	-2.45043000016810	14.39228972792900
H	-13.48487739717940	-4.84241027551984	14.40928872915012
H	-11.89617385129808	-6.33332464261764	14.44857753901594
H	-9.48508024039108	-6.63320784772808	14.50027853006131
H	-7.56751118315567	-5.57261921591744	14.52521015820527

H	-6.51753597378111	-3.38096795125850	14.50990131309631
C	-14.55571506595579	0.01683814610511	2.40701269586510
O	-15.61184820343880	-0.50826100604057	2.67317786376513
O	-14.41392778115320	1.31781485610247	2.15798519857547
H	-15.30881179259126	1.73075813114980	2.25537444642535
H	-17.07304765119758	1.18728409321523	2.67616811115839
N	-17.21792161980078	2.18683228877488	2.55007960204233
H	-17.08856324329728	2.51414985729627	1.59984017998559
H	-16.77376445127720	2.76771679521937	3.25185954344267

CNTO₃

C	-6.69456681317180	-2.99127244516577	0.01764958894594
C	-6.96538456374947	-1.65230836472638	0.02991444520569
C	-7.39337993428244	-1.00709633491435	1.24773943532678
C	-8.44749750405902	-0.03950436300627	1.26457616583512
C	-9.14854791338134	0.35013523943154	0.06523048665697
C	-10.50520504925632	0.51213818349983	0.08068674382218
C	-11.25141483641974	0.29452680745518	1.29637439648207
C	-12.50464457880567	-0.39694132518415	1.30459108816664
C	-13.09706483971682	-0.92059223840433	0.09635972993775
C	-13.66845107061094	-2.16079438064193	0.09243383340512
C	-13.68450875023136	-2.95766732641435	1.29648820129430
C	-13.39561412791482	-4.35951611853454	1.28170394099295

C	-13.07333710850962	-5.06184117526864	0.06312980309270
C	-12.06840888415650	-5.98749161553980	0.04517578176816
C	-11.31937045666594	-6.27329986561774	1.24475299674306
C	-9.89887868733549	-6.44550635581130	1.23037606533037
C	-9.12752067176445	-6.34493369861230	0.01487962390045
C	-7.93381410013373	-5.68060753725387	0.00899695542693
C	-7.43326477422288	-5.07265597717030	1.21832945741160
C	-6.83456734611462	-3.77315844586151	1.22251248177676
C	-6.76337078734118	-3.06460586072772	2.45817850319856
C	-7.04784257441857	-1.65378468154684	2.47102424409696
C	-7.39735091852442	-1.04596459380064	3.71630412832918
C	-8.44141440630506	-0.08617933866607	3.73301243210456
C	-9.09886326957550	0.23029953850190	2.50436854760136
C	-10.52778850704762	0.39960749013129	2.52023674332564
C	-11.21428269514226	0.23989633920488	3.76346215195874
C	-12.45435430878727	-0.44507829904568	3.77065039220629
C	-12.96484079987554	-0.94807635571506	2.53544130065306
C	-13.56756151077377	-2.25617590017810	2.53130521906212
C	-13.62107661389865	-2.97751371093780	3.76264754307349
C	-13.33561831676096	-4.36510925042887	3.74892755608241
C	-13.00793851712135	-4.98412892847688	2.50321704565781
C	-11.95062649625930	-5.96009701302359	2.48475138067409
C	-11.28564325978157	-6.26050685456392	3.71336595165343
C	-9.87766497160348	-6.43044039009691	3.69912234866941

C	-9.18563942055622	-6.29442175728414	2.45617602464392
C	-7.92843033220721	-5.59379160656682	2.45007128205557
C	-7.44025444665053	-5.07052492556632	3.68706288827636
C	-6.84677251355862	-3.78222996596744	3.69118847221110
C	-6.74928809599894	-3.07257675435499	4.93896486072493
C	-7.02786393128679	-1.68440003529531	4.95166861370467
C	-7.35799345589838	-1.05604332050681	6.19743960840244
C	-8.41002328830242	-0.08733021643032	6.21464127572819
C	-9.08674487852828	0.20816522208465	4.98498765798041
C	-10.49181098178937	0.37430416063725	4.99989993752636
C	-11.19201406901534	0.23616165832189	6.24345118550547
C	-12.44047071981154	-0.45459583541446	6.25162628941821
C	-12.94940953332044	-0.97126037606843	5.01419718957269
C	-13.54588973654341	-2.26578478685704	5.01010314810882
C	-13.61059427169852	-2.99496333070022	6.24355572078287
C	-13.32420224322068	-4.39270004919466	6.22875648211442
C	-12.97108504363593	-5.00807012210264	4.98283037458944
C	-11.93176030460025	-5.96802804453047	4.96536251656518
C	-11.27028102567594	-6.29669051853892	6.19490254661854
C	-9.85034095677090	-6.46684946605370	6.18022923355433
C	-9.15525600540332	-6.30288212800722	4.93694605099768
C	-7.91913469960969	-5.61241899779139	4.93085766742469
C	-7.40529160873637	-5.10120357446365	6.16799032627202
C	-6.80678427139384	-3.80184978360897	6.17213192225469

C	-6.71033771173306	-3.09594571310894	7.40717952562432
C	-6.99167725039793	-1.69185802425138	7.42019500481512
C	-7.34777145836703	-1.07900126393150	8.66477198879449
C	-8.39041378902205	-0.11884851061351	8.68146868937575
C	-9.05196820819674	0.20495691151115	7.45337365469676
C	-10.47413016929169	0.37194844381346	7.46830975616100
C	-11.16886219711875	0.20946044117681	8.70853412383180
C	-12.40967897500393	-0.47812823712544	8.71408657027579
C	-12.92530429576070	-0.98535775735989	7.47992632626739
C	-13.52548855144946	-2.28803158568061	7.47580344792486
C	-13.57869726343671	-3.01606453260704	8.70600489246313
C	-13.29487237419199	-4.40594342009998	8.69383443145759
C	-12.96381006471095	-5.03300999601150	7.45111894255585
C	-11.91271044747248	-6.00543117894816	7.43362155667178
C	-11.23959325676575	-6.30410795563776	8.66180699695268
C	-9.83224285625442	-6.47267289898410	8.64764193221904
C	-9.13200625894246	-6.33846220888223	7.40543126955577
C	-7.88197091378610	-5.63981253029476	7.39908787953087
C	-7.39128840378178	-5.10827467376768	8.63540746409710
C	-6.79824404294686	-3.82086870809357	8.63949010067420
C	-6.70630495017882	-3.11095455849553	9.88736463437813
C	-6.98518761740889	-1.72074407625322	9.90024670407643
C	-7.31409696063524	-1.10105146576279	11.14572574568116
C	-8.37282681153102	-0.12596540754120	11.16245379463398

C	-9.03887005603693	0.16994398613150	9.93254050146675
C	-10.44673585139368	0.33699770736350	9.94648713435650
C	-11.13902375420001	0.20335570759288	11.18995939700192
C	-12.39684232943676	-0.49751906920701	11.19627627054906
C	-12.88544239610499	-1.02098579450421	9.95934398674117
C	-13.47844206075755	-2.30819253252256	9.95523165004836
C	-13.56170167250377	-3.02622693666464	11.18819798456659
C	-13.27700278962996	-4.43768832049624	11.17515341629293
C	-12.92548966131165	-5.04411275946645	9.92934812573043
C	-11.88364439564739	-6.00561551608351	9.91288163058646
C	-11.22890403295175	-6.32583939571595	11.14277794523462
C	-9.79974288956438	-6.49681212267787	11.12863839246978
C	-9.11191811875989	-6.33763170035527	9.88562735217795
C	-7.87404649570941	-5.64606818236821	9.87933509100621
C	-7.36828371571694	-5.13887693817571	11.11647702799128
C	-6.76599469727233	-3.83146058496856	11.12060982261837
C	-6.64655869878880	-3.12907647125984	12.35521476888220
C	-6.92870463077763	-1.72477147200452	12.36823822519060
C	-7.25139944107826	-1.02104338871542	13.58505869733315
C	-8.25645909242522	-0.09492564816196	13.60070374525304
C	-9.00468734404983	0.18826343134506	12.40064430228435
C	-10.42717967228573	0.35826940076182	12.41468589653204
C	-11.19710312157533	0.25568071388788	13.63042908151385
C	-12.38980297966281	-0.41104331104173	13.63660769744823

C	-12.89076553345907	-1.01812294570974	12.42754589722892
C	-13.49007886935924	-2.31896319720900	12.42335227431146
C	-13.62914937653282	-3.10061944463639	13.62795354449509
C	-13.36082969062568	-4.44037234049414	13.61541325180760
C	-12.93524945174593	-5.08579640155208	12.39732718553496
C	-11.88145643767785	-6.05629668238549	12.38077547256666
C	-11.18291538369989	-6.44701117687791	13.58057112097809
C	-9.82582127837294	-6.60885974939983	13.56741598634948
C	-9.07828110484840	-6.39060825793323	12.35350651101393
C	-7.82753744276189	-5.69247254444706	12.34710652333892
C	-7.23962568896621	-5.16576872631186	13.55436591772355
C	-6.66777229973104	-3.92451651652887	13.55828894743052
H	-6.50144678249604	-3.49011375377682	-0.93380689858868
H	-6.98447630745389	-1.10100108115100	-0.91193958356809
H	-8.61572938096724	0.38834191477401	-0.88662598650172
H	-11.03543823880522	0.67759928747859	-0.85886603995489
H	-12.97552247906675	-0.38258859928039	-0.84552707394944
H	-13.99617706117670	-2.59782791691694	-0.85252982171109
H	-13.54167278815673	-4.76165117218882	-0.87593823291432
H	-11.74907070125859	-6.41241129280710	-0.90815887154130
H	-9.55680207648401	-6.68349175939995	-0.92984332438440
H	-7.42700139781170	-5.49807244592517	-0.94032453226927
H	-6.78540789523483	-1.32085430752969	14.52545622747695
H	-8.57723036486843	0.33041190710362	14.55333805673252

H	-10.76799609184661	0.59444067541663	14.57513325845830
H	-12.89551730474001	-0.59519750062171	14.58619376941542
H	-13.82038127685141	-2.60158932882445	14.57968574374264
H	-13.34202186850801	-4.99166735644452	14.55725460000485
H	-11.71701661621293	-6.48446679898279	14.53170623465758
H	-9.29737769126726	-6.77273335942221	14.50829806393370
H	-7.36797100529491	-5.69893605101791	14.49810635673452
H	-6.34827179201092	-3.48543357075817	14.50512582203344
O	-16.06341327436852	-1.50829380832049	5.15224549646584
O	-15.15941547905570	0.45516138554184	5.15352021364278
O	-15.93546904432126	-0.37701927783256	4.57818232841108

CNTNO

C	-6.61989784520643	-3.04357587389203	0.05948613048207
C	-6.89516604976847	-1.69424822924758	0.06142580354336
C	-7.32687239898002	-1.04381833958564	1.25839615561127
C	-8.40017664325599	-0.06374349390588	1.25534612268741
C	-9.08338383518632	0.30377738785168	0.05533501187515
C	-10.45194000766629	0.45783351809518	0.04924011117702
C	-11.21053751557116	0.25283284850072	1.24266564748160
C	-12.47451222688632	-0.46471947625983	1.23534536092874
C	-13.02907317476770	-1.00453339034754	0.03425406148678
C	-13.59819427518891	-2.25870740243063	0.02882311738247
C	-13.64313943410902	-3.04010738143128	1.22422926532785

C	-13.35209763326672	-4.46418633636869	1.22237949975589
C	-13.00481292069776	-5.16223525271485	0.02503301212139
C	-11.98873055968398	-6.09201027509238	0.02744664879301
C	-11.26566589570457	-6.37326165598076	1.22731856527205
C	-9.82130687961098	-6.53595453258080	1.23317758466824
C	-9.04432576744473	-6.42206037018036	0.03937908603738
C	-7.84718694080291	-5.74119008592858	0.04644300736454
C	-7.36273189817932	-5.13794557007129	1.24776008047485
C	-6.76125116742310	-3.81463789852048	1.25426762324228
C	-6.73315829621016	-3.10106463900105	2.48244644367335
C	-7.02041825115731	-1.69291382432177	2.48450766139824
C	-7.38593276460945	-1.07671447526250	3.72883045253178
C	-8.43495794241920	-0.11672962635824	3.72645130922349
C	-9.07762793702906	0.18766470930011	2.47871872974592
C	-10.50540987388694	0.34855806656037	2.47248378918152
C	-11.21100406458490	0.19654192374054	3.71433322764189
C	-12.44766994071177	-0.50622766513646	3.70707575610390
C	-12.92850476439977	-1.02788023857116	2.45830289888216
C	-13.52206209990336	-2.33635402496584	2.45265975867489
C	-13.60174698873364	-3.05070875773951	3.69608765775466
C	-13.31663772937631	-4.44433038563407	3.69425518467869
C	-12.96344194045427	-5.06679606791995	2.44905812791099
C	-11.90351299422638	-6.03683389314351	2.45161442405909
C	-11.25527120029555	-6.33034829741579	3.69920875709792

C	-9.84192393510132	-6.49045623184769	3.70500777831964
C	-9.13446017665855	-6.34944278121751	2.46293540512447
C	-7.88538111627641	-5.63928793496540	2.47014538254511
C	-7.41326447821025	-5.11018913757655	3.71905680251239
C	-6.82647967287400	-3.81495249424152	3.72478557867125
C	-6.73572932643366	-3.10642005998676	4.95986776287427
C	-7.02342791374601	-1.69662155238250	4.96202863885405
C	-7.38601474990245	-1.07620578776708	6.19171073014075
C	-8.44065788606649	-0.10799556933150	6.18920053167247
C	-9.08781758231389	0.19458296813601	4.95704910196469
C	-10.51652052850973	0.35618112519292	4.95078279498958
C	-11.22576240867054	0.20619049770629	6.17712229255112
C	-12.47049944196518	-0.50127820574675	6.16969467084654
C	-12.95118190637193	-1.02766541104275	4.93639673811495
C	-13.54523012691140	-2.33725867455120	4.93064000735785
C	-13.62825899438196	-3.05473462794325	6.15838990086296
C	-13.34115650789137	-4.45734796893419	6.15652993560136
C	-12.98331588436524	-5.08123662160232	4.92698944868759
C	-11.92250805640412	-6.05215893124304	4.92963085600005
C	-11.27244577181532	-6.34971170622911	6.16167694820745
C	-9.84985510217088	-6.51121930900377	6.16771019981094
C	-9.13959842371928	-6.36714170531903	4.94124832296002
C	-7.88911091502674	-5.65734471480514	4.94847872620852
C	-7.41233434476818	-5.12753673491995	6.18159776115007

C	-6.82299997888691	-3.82266753693801	6.18737770211251
C	-6.74668909791102	-3.10900212977034	7.42790088044492
C	-7.03458448770897	-1.70598574449155	7.43001500918431
C	-7.39091089828047	-1.08191501256812	8.65994516845783
C	-8.45197800228858	-0.11161869598536	8.65777934071948
C	-9.10238475795260	0.18723872591776	7.42605436723605
C	-10.52498166345342	0.34786145297930	7.42006568111814
C	-11.23515215923170	0.20286223489505	8.64636334545740
C	-12.48572342634704	-0.50703375627813	8.63881724124721
C	-12.96236467110352	-1.03694740175952	7.40543411885307
C	-13.55363931744837	-2.34082182147461	7.39962111828249
C	-13.64262536988233	-3.05773213429312	8.62730361017883
C	-13.35411783607302	-4.46659048372570	8.62545962422980
C	-12.99094304060025	-5.08748612036514	7.39595771211415
C	-11.93453925658998	-6.05376754881835	7.39862304278120
C	-11.28690754155083	-6.35638943812666	8.63077660607291
C	-9.85804887873283	-6.51838412670353	8.63685334554149
C	-9.14882801344937	-6.36927142603610	7.41046119255278
C	-7.90364017312966	-5.66267247948643	7.41748236299649
C	-7.42256999663859	-5.13550628568892	8.65041460253274
C	-6.82830311539837	-3.82622700356734	8.65581980839731
C	-6.77056770656522	-3.11245340950969	9.88996678206793
C	-7.05588720713017	-1.71864055266850	9.89215440304978
C	-7.40920088845773	-1.09675582556996	11.13743415728445

C	-8.47059557003791	-0.12816627583827	11.13555471864602
C	-9.11917820888805	0.16571421950440	9.88839611172440
C	-10.53269464823561	0.32559083219426	9.88250954144633
C	-11.24014304084831	0.18437470629811	11.12438114956241
C	-12.49013333095397	-0.52411545207888	11.11683473011107
C	-12.96261539779957	-1.05305536483690	9.86791317819328
C	-13.55049309829802	-2.34838320647823	9.86204485285793
C	-13.64226736851631	-3.06147498331424	11.10534286854527
C	-13.35348380203412	-4.46897043151794	11.10348157688363
C	-12.98925147128789	-5.08536970412030	9.85841613331429
C	-11.93931737633458	-6.04519998269235	9.86115807401091
C	-11.29609206594191	-6.34890455118046	11.10887609256899
C	-9.86832462059231	-6.51000229974993	11.11495667961786
C	-9.16308994729802	-6.35874792260597	9.87297790064256
C	-7.92593928613787	-5.65658042279504	9.87983364044932
C	-7.44446966123157	-5.13475187474082	11.12818241744579
C	-6.84988888919297	-3.82669553753913	11.13337940981910
C	-6.72772146465012	-3.12297148387978	12.36184533889343
C	-7.01941515606864	-1.69914243647096	12.36396567659370
C	-7.36754366094362	-1.00184788063917	13.56156214352542
C	-8.38507846081512	-0.07365336350148	13.55976877566169
C	-9.10874107250045	0.20703674856161	12.36009009625136
C	-10.55303939185334	0.36990569799544	12.35424705846910
C	-11.33034317771330	0.25760224227235	13.54789288835472

C	-12.52881983893592	-0.42097990150138	13.54065823334712
C	-13.01380551797555	-1.02399814908783	12.33948872802670
C	-13.61506630214779	-2.34730955318562	12.33343534508045
C	-13.75519386075658	-3.11817612402196	13.52830765419301
C	-13.47818872945428	-4.46730686618759	13.52654856898405
C	-13.04630414597395	-5.11758949617725	12.32980193185940
C	-11.97311421175612	-6.09785745937215	12.33265659381455
C	-11.28953375647615	-6.46515590685014	13.53240446720943
C	-9.92091251269236	-6.61925915899118	13.53825005903362
C	-9.16268430292754	-6.41440749530869	12.34460645950788
C	-7.89841654651393	-5.69740912917469	12.35147842327090
C	-7.34254512365757	-5.15812549382846	13.55218012949034
C	-6.77224533344899	-3.90446645607715	13.55721805186768
H	-6.44794475009966	-3.54437465910032	-0.89498456102431
H	-6.93363915835434	-1.16340037617296	-0.89150210560078
H	-8.54887099886357	0.30857733035078	-0.89630189676171
H	-10.96349012229509	0.58024081342718	-0.90716034838074
H	-12.86367640504387	-0.49752645246128	-0.91809009156048
H	-13.86820153420918	-2.70995487168397	-0.92763525423763
H	-13.43115458388201	-4.85103170938390	-0.93035282916201
H	-11.63832319151074	-6.49109479537623	-0.92612289297491
H	-9.46706580597589	-6.73331600467055	-0.91758469611366
H	-7.35496660696665	-5.53215742083512	-0.90506593215405
H	-6.94051313939638	-1.31267826718748	14.51676294298719

H	-8.73570717856461	0.32478554080999	14.51352576340357
H	-10.90730272764659	0.56851429596109	14.50483607094273
H	-13.02158247663971	-0.62899969490317	14.49211219058019
H	-13.92683478842023	-2.61734481965396	14.48281443009303
H	-13.43818620553801	-4.99767851537443	14.47968470725059
H	-11.82371885146823	-6.46957154116571	14.48424310143164
H	-9.40914535494472	-6.74181994345118	14.49450946408999
H	-7.50742156105987	-5.66516800250746	14.50460072167878
H	-6.50117700042639	-3.45341502550288	14.51346876747744
N	-4.06335459449512	-1.73400425478571	5.41897881790469
O	-3.97151002054051	-1.81354461379917	6.56338431764112

CNTHg

C	-6.66904032806323	-2.99414852574854	-0.00168013998150
C	-6.96202289281076	-1.66042635525501	-0.00048505201621
C	-7.41107346152616	-1.01431049176189	1.21033602809601
C	-8.47981285866411	-0.06476269958690	1.21231317306751
C	-9.17726975823888	0.30666090924340	0.00366683380828
C	-10.53619403785983	0.44103337956608	0.00590315702144
C	-11.28873403126704	0.21280506361334	1.21702565860065
C	-12.52266653766078	-0.50938382521343	1.21883592448387
C	-13.09335572028243	-1.05484652179729	0.00962997199141
C	-13.64006720193253	-2.30612695796195	0.00952033903878
C	-13.65290835892309	-3.09561657596397	1.21863746404092

C	-13.34565183593710	-4.49193512070698	1.21671649879504
C	-13.00279656054517	-5.19952425616222	0.00552694399730
C	-11.98202825367188	-6.10658384838617	0.00316743934182
C	-11.23588011238514	-6.36715003588084	1.21172487989983
C	-9.81319107959485	-6.50789275485938	1.20973271482073
C	-9.03399380326502	-6.39870598253140	-0.00110227142814
C	-7.85583753486810	-5.70836420415513	-0.00211955813427
C	-7.37820440567091	-5.08099585728008	1.20765484261128
C	-6.80569831532668	-3.77102964294401	1.20786164653260
C	-6.75607861252230	-3.05330261784123	2.43963365322975
C	-7.06458159534832	-1.64716818955915	2.44091879398831
C	-7.43440117109274	-1.03732583650635	3.67885395522254
C	-8.49395019707906	-0.09452118810309	3.68085785082010
C	-9.14593605106968	0.20333642009975	2.44488279000768
C	-10.57856513114057	0.34495278842204	2.44714024891625
C	-11.27186934307876	0.17997928913898	3.68532974125644
C	-12.49516093836634	-0.53783403342406	3.68676045254029
C	-12.98178667936465	-1.06320657158602	2.45060721658165
C	-13.55829092938881	-2.38262123967432	2.45049656080944
C	-13.61315599950643	-3.09681035493989	3.68654655017091
C	-13.30982483729882	-4.48231193458699	3.68497727348610
C	-12.96059725925152	-5.10331969499049	2.44672133663095
C	-11.88468455903853	-6.05983012784647	2.44435695099140
C	-11.22349542574607	-6.33694575160832	3.68026432101704

C	-9.81204745557640	-6.47595095388693	3.67828781257525
C	-9.11317230110146	-6.33331449301217	2.44035781444908
C	-7.87120879109215	-5.60530424232406	2.43928917661535
C	-7.40424751514618	-5.06377220890121	3.67616378888873
C	-6.83643293244570	-3.76408324701805	3.67632378115061
C	-6.76226320845263	-3.04448625023481	4.92070685553711
C	-7.06511417545192	-1.66185474356248	4.92205112588880
C	-7.41481604316557	-1.03065408316153	6.16091798246222
C	-8.48388789385193	-0.07891043883779	6.16308858472626
C	-9.15424619678232	0.19731511961436	4.92614210838488
C	-10.56269910879010	0.33677545951143	4.92821388227711
C	-11.26995717276238	0.19647752164940	6.16726339822640
C	-12.50259192680034	-0.53027726553984	6.16853296908534
C	-12.97270312188204	-1.08053861017369	4.93115449053900
C	-13.53953042889132	-2.37790876256782	4.93108539244050
C	-13.62386032000784	-3.09695597447345	6.16831461394623
C	-13.32082279969037	-4.49540462742637	6.16687618562802
C	-12.94372243799551	-5.10977954427033	4.92775919999730
C	-11.88588914746916	-6.05006704911581	4.92557562153912
C	-11.22820884922374	-6.35535871213431	6.16251880139150
C	-9.80372465057728	-6.49534417061473	6.16041001516312
C	-9.10275636354686	-6.32362147971534	4.92157454154659
C	-7.88187702460904	-5.60740111385082	4.92042304673897
C	-7.38828461988459	-5.07813731910927	6.15800059507876

C	-6.81527906524739	-3.76646521539046	6.15812902432857
C	-6.74316289025237	-3.05094520495468	7.38864490039472
C	-7.04943212010741	-1.65279461162530	7.39012664697314
C	-7.42698191526545	-1.03807889474873	8.62918451920109
C	-8.48427190959302	-0.09717688812582	8.63149392728866
C	-9.14144335184352	0.20898093641092	7.39459419082632
C	-10.56569130164486	0.34979445349118	7.39677898720792
C	-11.26725827855969	0.17760921723111	8.63546469961537
C	-12.48794053809873	-0.53871632817548	8.63662355143233
C	-12.97903577752667	-1.06938957979994	7.39886423673398
C	-13.55222518159111	-2.38123579582176	7.39875030128251
C	-13.60795779270833	-3.10243610837974	8.63637499827541
C	-13.30530754578525	-4.48496109787977	8.63500813884810
C	-12.95551735745565	-5.11690094200681	7.39625339348615
C	-11.88594404651438	-6.06786337577311	7.39403066807472
C	-11.21526639170061	-6.34310713000618	8.63094730621406
C	-9.80673470308128	-6.48174474419846	8.62873888226450
C	-9.09890915797146	-6.34166018964337	7.38973436093813
C	-7.86430828899935	-5.61744839705937	7.38842446781427
C	-7.39455217575733	-5.06689801198496	8.62604702208840
C	-6.82793669410516	-3.76989653666613	8.62614474278616
C	-6.75687956014868	-3.05014698558944	9.87059838155199
C	-7.06072226777600	-1.66474263727696	9.87215823034513
C	-7.41003178201510	-1.04328381742254	11.11025329990108

C	-8.48598902691171	-0.08693120376071	11.11258733642315
C	-9.14681600263316	0.19020313103894	9.87670812889833
C	-10.55829649449668	0.32977398375906	9.87878132039636
C	-11.25764861722157	0.18699226989341	11.11637485537467
C	-12.49999390449904	-0.54058477336820	11.11725802760391
C	-12.96705471277480	-1.08202302423123	9.88046454990914
C	-13.53501195532589	-2.38193626475876	9.88031100551100
C	-13.61524553805894	-3.09270410878199	11.11694344110050
C	-13.30615364954748	-4.49883368422433	11.11583765411040
C	-12.93609690404449	-5.10911518356675	9.87823602533724
C	-11.87606831413628	-6.05150823039022	9.87613029067165
C	-11.22432595437448	-6.34907154559121	11.11207909640974
C	-9.79177251851700	-6.49075814457095	11.10985603875303
C	-9.09808118167954	-6.32553931853493	9.87184460374395
C	-7.87449963772492	-5.60815862402645	9.87043555441372
C	-7.38919054374223	-5.08258906375267	11.10705499053774
C	-6.81275960479769	-3.76346201767687	11.10714291924063
C	-6.71836172501220	-3.05025904521061	12.33900060538338
C	-7.02508395573645	-1.65406844311942	12.34060740882028
C	-7.36792657945161	-0.94605543140313	13.55164499866641
C	-8.38879180258625	-0.03919674281105	13.55385339147449
C	-9.13511199309676	0.22055063890914	12.34516009420594
C	-10.55766137480793	0.36125038774602	12.34711946806443
C	-11.33706947596380	0.25228065894569	13.55793714242566

C	-12.51537600651842	-0.43768585907628	13.55883159306481
C	-12.99301661083170	-1.06503939691548	12.34894286157402
C	-13.56549570026976	-2.37485927898328	12.34874920336843
C	-13.70217661293207	-3.15174113571094	13.55841641191621
C	-13.40884218956585	-4.48532209876965	13.55733958901954
C	-12.95942890088524	-5.13142888590337	12.34653760790497
C	-11.89080719597060	-6.08088878114771	12.34459473434694
C	-11.19378253481975	-6.45289773670385	13.55337219144834
C	-9.83494576490144	-6.58752747808979	13.55127650218905
C	-9.08213412362668	-6.35888137279727	12.34031423764359
C	-7.84871949732271	-5.63629708935040	12.33883414940893
C	-7.27850162283751	-5.09068299775316	13.54820033429523
C	-6.73162945863079	-3.83949768190212	13.54827504606809
H	-6.45754294560838	-3.49588773608916	-0.94771681464907
H	-6.98061220067238	-1.11458600070859	-0.94556236931324
H	-8.63548299299499	0.35323458670161	-0.94277462422780
H	-11.06154591718365	0.59308939634114	-0.93872420400999
H	-12.97228001581988	-0.52239780254748	-0.93551382385697
H	-13.94923875600059	-2.75615949866718	-0.93563345581766
H	-13.47111201477892	-4.91678077277874	-0.93902685439656
H	-11.64872113038669	-6.53615191642362	-0.94331424327130
H	-9.44745489422035	-6.75525723023235	-0.94629608402996
H	-7.34395724189166	-5.52259607268347	-0.94811862742729
H	-6.89909257236409	-1.22804884614352	14.49617618263446

H	-8.72217403208283	0.39065894599718	14.50017680929632
H	-10.92371116002171	0.60896101369270	14.50312623420296
H	-13.02764142232764	-0.62305408969739	14.50469318008847
H	-13.91431592971680	-2.65000501533686	14.50430363863505
H	-13.39044658641785	-5.03117299200703	14.50241511833724
H	-11.73585920818346	-6.49992256865195	14.49962386838850
H	-9.30976704507888	-6.74009444306984	14.49592767269610
H	-7.39986277463167	-5.62302933918448	14.49337042560365
H	-6.42330909914601	-3.38908368652497	14.49353373879033
Hg	-16.29299397748439	-0.39605393806544	6.16586597019641

ffCNTSO₂

C	-6.57555479913756	-3.13061952501140	0.02270807057904
C	-6.89813454864568	-1.79923062540134	0.02247792453792
C	-7.36260809085438	-1.16023344507304	1.22542339919734
C	-8.42667682495536	-0.20964933410316	1.22546388491164
C	-9.10698834519444	0.18081198929792	0.01596006464728
C	-10.45456371710397	0.38888691980533	0.01578633152391
C	-11.23654181808208	0.23928629846669	1.22782110424967
C	-12.55229593791787	-0.21471794201369	1.20842980304587
C	-13.16404671718130	-0.74598760699096	0.00401277645902
C	-13.72406017100215	-1.98667305841292	0.03800316209460
C	-13.63307859696938	-2.77824811139812	1.26666453280429
C	-13.25249484045082	-4.17558017584585	1.23992939435773

C	-12.90477953916317	-4.84355575324958	0.02759400221599
C	-11.92994969462806	-5.81689326729357	0.01341157562812
C	-11.24139348116763	-6.17820262889486	1.21135717719843
C	-9.82408051886845	-6.46412818823692	1.21545932813647
C	-9.03715480069659	-6.41982852284960	0.01688107686707
C	-7.80805189389045	-5.81036381950007	0.02138784008809
C	-7.30312892478627	-5.21449691069885	1.22569568081760
C	-6.70700997245593	-3.90509538255029	1.22704885699214
C	-6.68089598254632	-3.18373563622517	2.45621852706911
C	-7.00462377692733	-1.79029081664138	2.45721814663772
C	-7.38038088219519	-1.17888946506020	3.69469895631831
C	-8.43864020372848	-0.22893283023046	3.69770161799725
C	-9.10396798741359	0.06882918730909	2.45883151712587
C	-10.49746425306803	0.33685474727477	2.46548098240612
C	-11.20750610891916	0.25603984988070	3.70859307320812
C	-12.52766263547508	-0.23358343395934	3.73806159509970
C	-13.30575878768953	-0.58662301629099	2.47657367016066
C	-13.56766828614053	-2.09814104522246	2.47808815667818
C	-13.54639843032114	-2.80285767044068	3.71953968125691
C	-13.20363327772845	-4.18868821042967	3.70624370271128
C	-12.86662061098292	-4.80134067703650	2.45940388445717
C	-11.85646836856909	-5.81980540405408	2.44547896789668
C	-11.22976471594492	-6.17661668325228	3.68341006542395
C	-9.83216508943551	-6.44401411205985	3.68655176418535

C	-9.11924979085442	-6.34613599630003	2.44586804895283
C	-7.83227268287267	-5.71062030552380	2.45196785126542
C	-7.34492484341547	-5.19207339655390	3.69511314304406
C	-6.75243444951477	-3.89928819325859	3.69726688705812
C	-6.67230742805484	-3.18466723312642	4.93155273728519
C	-6.99905704784717	-1.78989826579564	4.93018483270656
C	-7.35797245357798	-1.16669343604752	6.16370191596838
C	-8.41602868494807	-0.20728821459138	6.16637770840435
C	-9.07278051458493	0.09022082531053	4.93661144454912
C	-10.48423233579569	0.32382141834386	4.94573088876925
C	-11.19572053234926	0.26118499605645	6.18969412300186
C	-12.51388070404533	-0.24824434884294	6.18161506884794
C	-13.03046087214760	-0.72828904324878	4.96168668423971
C	-13.56342284204861	-2.09787124832551	4.95411387398762
C	-13.55121081590019	-2.82112684451801	6.17969978756336
C	-13.21719393774496	-4.21475834224440	6.16333776321302
C	-12.87367505686397	-4.83746920326774	4.92898667996065
C	-11.86821143402815	-5.85555073399031	4.92057470927323
C	-11.24167107109865	-6.21419383907135	6.15228308631986
C	-9.83526399986298	-6.47199920691684	6.15488737325900
C	-9.12031700529250	-6.36832900329967	4.92307424851069
C	-7.84498418636811	-5.71575341519348	4.92879508410950
C	-7.34634698620166	-5.19968263274126	6.16364881749965
C	-6.74588010045116	-3.90084621995279	6.16335133681372

C	-6.67693964830692	-3.17917460927853	7.39792626878966
C	-6.97867825407213	-1.78543709704484	7.39577169516633
C	-7.34578958595511	-1.16114163551740	8.62920779987437
C	-8.39406264983335	-0.20384805745237	8.63540136215703
C	-9.07133669628792	0.10120336299600	7.40675494252660
C	-10.46298585743097	0.35582901883977	7.41948160820639
C	-11.17550089096671	0.22419519999082	8.66874283042936
C	-12.46934401278537	-0.29377280920676	8.70141772517535
C	-13.26644437633904	-0.62227562716754	7.45380168729740
C	-13.53955655303890	-2.13229685557978	7.42866142970057
C	-13.56282597029693	-2.84352544922461	8.62782044813982
C	-13.24048762243582	-4.24487027011881	8.62183320028622
C	-12.89009466005232	-4.86431223590068	7.39010366310399
C	-11.88383945193205	-5.88482709269326	7.38620992127127
C	-11.25498314764841	-6.22357945707999	8.61701176872388
C	-9.84584208086424	-6.46470095843139	8.62285691952837
C	-9.12543051674543	-6.36911402973929	7.39365958487021
C	-7.85136046982175	-5.71854166001608	7.39827772265808
C	-7.36191842049652	-5.19070760788744	8.63175559770612
C	-6.76103108136469	-3.89578843510335	8.63139044995295
C	-6.68794878610846	-3.17571280415535	9.86783912566101
C	-6.97926486442230	-1.78651641955908	9.86683863803315
C	-7.30704452455806	-1.15337581886026	11.10865568442231
C	-8.35452669649327	-0.16872698268227	11.11616780643731

C	-9.02726356700491	0.11372749437110	9.88237802787820
C	-10.42691782877686	0.32522991151098	9.90186313951996
C	-11.10930068138270	0.24708362312691	11.15503723956664
C	-12.39497502571825	-0.39191177465848	11.17198865045949
C	-12.93067834834083	-0.85786560420742	9.93155306625065
C	-13.52485540998458	-2.14813212323149	9.90713463229658
C	-13.60391514262703	-2.88288965925277	11.12143679787268
C	-13.30025738234412	-4.29744202386151	11.10298158161394
C	-12.90933559749188	-4.88897371127796	9.85264237764658
C	-11.89713013349133	-5.88449918646840	9.85099260276140
C	-11.27618100143152	-6.23020003882029	11.09415991503451
C	-9.85685163153356	-6.45788015229798	11.10238579029502
C	-9.14291771029956	-6.34314910885283	9.86434872718405
C	-7.88049275846417	-5.69375366508311	9.86868849961030
C	-7.38322388227876	-5.18147066471914	11.11180323399886
C	-6.76126277693916	-3.88527260388351	11.11061916638079
C	-6.63756559485853	-3.17499718776898	12.33640477103637
C	-6.91008146952445	-1.75873762985588	12.33459368046154
C	-7.22023802233911	-1.04181315274348	13.53943075523615
C	-8.21732235137617	-0.10144436468344	13.54736077415305
C	-8.96567357793931	0.18077993774013	12.35330427589315
C	-10.38799360842606	0.39026730210365	12.37573440875435
C	-11.14959832061933	0.30087994697748	13.59280804394376
C	-12.36155439932097	-0.33774696120422	13.60548460166392

C	-12.89319166493324	-0.91296865498370	12.39814828349835
C	-13.53330761079610	-2.19741712192510	12.37346077185247
C	-13.69309770413292	-2.99085118723577	13.56312852349568
C	-13.44545238833624	-4.33571570638101	13.53678462243155
C	-13.00358689143919	-4.96308785597606	12.31605498008483
C	-11.94631279114910	-5.95065066548844	12.31623501864026
C	-11.27762088986379	-6.34194025720933	13.52203270396859
C	-9.91915021584181	-6.54659778385381	13.53106651355911
C	-9.14987165275707	-6.38028695761902	12.33366505468564
C	-7.86590131367386	-5.71614504670227	12.33813779435760
C	-7.28907214627892	-5.18975421732930	13.54186905515530
C	-6.69223725230945	-3.95413807923967	13.54064299084903
H	-6.36641400734598	-3.62913320355260	-0.92558725834471
H	-6.93388260550345	-1.26159218889808	-0.92672357986796
H	-8.56341754746063	0.19821734421104	-0.93065255015777
H	-10.96750982907433	0.57051414717082	-0.93051371359768
H	-13.07642396680136	-0.21672673287475	-0.94923433961768
H	-14.12532175176743	-2.43797809669261	-0.87106296943356
H	-13.30763083406163	-4.48659420926398	-0.92112920522918
H	-11.58450716259818	-6.20056948052409	-0.94795863118647
H	-9.47493260202999	-6.72626100507090	-0.93475831454251
H	-7.29417605834985	-5.64327805793083	-0.92705683311055
H	-6.76295855810671	-1.34116263585990	14.48421925485245
H	-8.53144296662897	0.33123552371883	14.49887188955877

H	-10.70170915888754	0.60994015785103	14.53891491193700
H	-12.85471783202160	-0.52680401668399	14.56085998350258
H	-13.88598106585294	-2.50082310688158	14.51965867583317
H	-13.45234574311575	-4.90168785337710	14.46969753681226
H	-11.81668876930250	-6.33234724350271	14.47054982718536
H	-9.41272563359154	-6.69109022698258	14.48706956063967
H	-7.45704617490793	-5.69713319980055	14.49346117693081
H	-6.39715382644721	-3.50750428804881	14.49181556458823
C	-14.57743474775305	0.22221395608213	7.43460417950336
O	-14.69707838880082	1.27522106915431	8.00405649437943
O	-15.49642728324487	-0.34618413482861	6.65800699189426
H	-16.23811781267129	0.27151555955850	6.47323145177215
C	-14.63180812467423	0.20815903731592	2.59092619356424
O	-15.65302656389036	-0.28597129675040	3.04353673773901
O	-14.50192520955411	1.47203152144691	2.23301649039051
H	-15.31843579910368	1.97072981497793	2.47554425539422
S	-17.52690035963077	1.19192136804437	3.85170760627153
O	-16.79775961852640	2.38444519127825	3.36083278533680
O	-17.46415202990491	0.96371573806364	5.30666248520497

ffCNTPTFE

C	-6.55696344050231	-3.10922700482062	0.02338053192396
C	-6.89365201562884	-1.78240068283867	0.01821672312120
C	-7.37605552175936	-1.14712483376898	1.21789445228387
C	-8.44865132159520	-0.21255585342990	1.21022349649545
C	-9.12274964721649	0.17332196016958	-0.00679162338774
C	-10.47116310494030	0.36115201378223	-0.01762701321884
C	-11.25977962982747	0.19887924595018	1.19088603118751
C	-12.56173970631449	-0.27202671839188	1.16500187581155
C	-13.16951144863208	-0.80659049274294	-0.04304275539965
C	-13.72490308890125	-2.04604925440920	-0.00264770483854
C	-13.63359679309377	-2.82923706146573	1.23462000400941
C	-13.23752602256779	-4.22086325535089	1.21465356497450
C	-12.87710022546428	-4.88892773674338	0.00517179416367
C	-11.89013715905619	-5.84923747523281	-0.00269091701590
C	-11.20065848628431	-6.19691777021124	1.19956848815636
C	-9.78179013672895	-6.46929467561615	1.21013928741481
C	-8.99012841616773	-6.41996891469215	0.01396123455443
C	-7.76698595015368	-5.79991711431993	0.02198463405027
C	-7.27259521803438	-5.19630649793076	1.22782547447861
C	-6.68945000990705	-3.88360240064143	1.22939600924040
C	-6.67588758664215	-3.15933108357440	2.45789593567361
C	-7.01601007023183	-1.77081021234459	2.45471950785941
C	-7.40474048815684	-1.16132351139303	3.68750273122261
C	-8.47640594056607	-0.22416823198355	3.68358234368501

C	-9.13820358468542	0.06130538595584	2.44023479865864
C	-10.53261548291282	0.31295465938632	2.43868792774369
C	-11.25201715033728	0.23804966180275	3.67641166525736
C	-12.57481685345426	-0.25385604045844	3.69939491513836
C	-13.33355492347450	-0.62365635451705	2.42912246133619
C	-13.58446161773735	-2.14086810828121	2.44189225108981
C	-13.55822980961737	-2.83847847498767	3.68714453282395
C	-13.19404563804749	-4.21884306257826	3.68004044232739
C	-12.84681224533046	-4.83490949461844	2.43778538416768
C	-11.82464303239112	-5.84166514498801	2.43066050247934
C	-11.19926679152235	-6.18902014834767	3.67131967427700
C	-9.79944755253318	-6.44566137135102	3.68115247039105
C	-9.08244504524963	-6.34358864901911	2.44325229053249
C	-7.80123246627511	-5.69716014552175	2.45386899570934
C	-7.32319847183237	-5.17324214827920	3.69758404930079
C	-6.74379560903594	-3.87349469737684	3.69995008231821
C	-6.67872346885081	-3.15559268947542	4.93204514269179
C	-7.02321430037426	-1.76532839402212	4.92577370883150
C	-7.39712456595787	-1.14340026630101	6.15530003099237
C	-8.46504739417666	-0.19736096783266	6.15054460144570
C	-9.12162423804521	0.08949452047314	4.91612733351099
C	-10.53533619642673	0.31248887183995	4.91794897896688
C	-11.25255825726069	0.25094950310663	6.15967341096618
C	-12.57017311149955	-0.25565316400849	6.14662421124030

C	-13.08028105482037	-0.74524992563019	4.92248301848340
C	-13.58899763701132	-2.12620469638990	4.91913029291013
C	-13.56068764804686	-2.84639091795390	6.14697883152866
C	-13.21223927956243	-4.23723670222087	6.13626501678344
C	-12.85905914930662	-4.85999347563392	4.90631124409144
C	-11.84529501759163	-5.86982835729331	4.90486576367931
C	-11.22108551291991	-6.22122411388551	6.13968053391504
C	-9.81321300531543	-6.46889499432022	6.14949608852089
C	-9.09357931088147	-6.36185683565013	4.92034894260774
C	-7.82396361386476	-5.69855876447192	4.93037246367746
C	-7.33645203863022	-5.17436421570838	6.16651625789340
C	-6.75035909010753	-3.86995877114356	6.16605199130064
C	-6.69481586210440	-3.14412503266162	7.39842985025131
C	-7.01203428087185	-1.75296854312235	7.39114651126205
C	-7.39034114479621	-1.12896889730923	8.61863465724180
C	-8.44864286214605	-0.17917601745468	8.61694774541205
C	-9.12687361648786	0.11200419425534	7.38606337291289
C	-10.52087583751912	0.36045576918267	7.39245259661921
C	-11.23306942550909	0.22676655760191	8.63769576998731
C	-12.52583439184577	-0.30039127707841	8.66947715459814
C	-13.31981133715813	-0.64360732128399	7.41974519097110
C	-13.55953244833398	-2.15751930976410	7.39521239035005
C	-13.58291903406541	-2.86580626589128	8.59677013383950
C	-13.24645252390849	-4.26387185324921	8.59554466724775

C	-12.88442251127068	-4.88124618613691	7.36642718114614
C	-11.87151184290753	-5.89455724199902	7.36990960553702
C	-11.24711158509977	-6.22782944213992	8.60433455038054
C	-9.83522255645921	-6.45749149298246	8.61723944846093
C	-9.11007115406120	-6.35834976240327	7.39144044407680
C	-7.84146210699315	-5.69619351005461	7.40064961513645
C	-7.36327267588496	-5.16062015596797	8.63410219195424
C	-6.77585815644258	-3.85788597336701	8.63285211257779
C	-6.71818046168616	-3.13313962035713	9.86649895519173
C	-7.02400997947582	-1.74705750306791	9.85951389531698
C	-7.36220248998342	-1.11262217832299	11.09827736817895
C	-8.41758934543823	-0.13648946488572	11.09803766928361
C	-9.08822030616183	0.13597424102272	9.85956212419208
C	-10.48982745363447	0.33562301562605	9.87282676080274
C	-11.17563949499954	0.25387901641967	11.12490893668294
C	-12.45427024237305	-0.39840872590933	11.13904024425560
C	-12.98211548528542	-0.87015097168537	9.89587692771331
C	-13.56412507635541	-2.16821877963876	9.87233605005567
C	-13.63807868411206	-2.90133213419348	11.08912567045544
C	-13.32010700419543	-4.31232426868423	11.07583790111232
C	-12.91756477929098	-4.90330844576788	9.82865344243827
C	-11.89743786413898	-5.89114425303957	9.83378056597664
C	-11.27967041938937	-6.22867724239379	11.08124361869585
C	-9.85848189509030	-6.44362543544052	11.09672056497787

C	-9.13959017203610	-6.32577189588259	9.86131462946385
C	-7.88366965810390	-5.66387604653992	9.86979558460361
C	-7.39806397940740	-5.14221081333178	11.11411274701232
C	-6.78984087531431	-3.83952867269315	11.11190171901420
C	-6.67752061894814	-3.12460427469086	12.33526545901899
C	-6.96295253289562	-1.70901485629208	12.32742368204125
C	-7.28408203025888	-0.99123888441861	13.52740578184290
C	-8.28929400838198	-0.05817562939526	13.52778853005882
C	-9.03463118638048	0.21397769569722	12.33088856627969
C	-10.46124818969296	0.41044460264755	12.34757416590434
C	-11.22516511205761	0.31423386541351	13.56057379062272
C	-12.43152641514698	-0.33785698655770	13.57023151409903
C	-12.95354978203945	-0.91945537737043	12.36380165253602
C	-13.58276737047599	-2.21281551312749	12.33971504445685
C	-13.73733993082365	-3.00407187594015	13.52906226951641
C	-13.47718698240454	-4.34823386746869	13.50781294826196
C	-13.02571067503616	-4.97409077421336	12.29213077023926
C	-11.95856910895938	-5.95327725434683	12.29913409536021
C	-11.29216895802844	-6.33560653978013	13.50811470239698
C	-9.93122495213090	-6.52739371308668	13.52408768341875
C	-9.15806139386734	-6.35736193059572	12.33074026627837
C	-7.88004634348179	-5.67885095871105	12.33950266694207
C	-7.31590879064871	-5.14204808023342	13.54359590267740
C	-6.73160994543486	-3.89964310397810	13.54107958926944

H	-6.33233165455527	-3.60732055659700	-0.92164287933314
H	-6.92553902744169	-1.24530825445461	-0.93144841159645
H	-8.56871856526811	0.20451925905826	-0.94698881983537
H	-10.98120214838970	0.54119812831335	-0.96588106264442
H	-13.09153460020628	-0.27280515311352	-0.99448469288858
H	-14.13178381981185	-2.50343593068237	-0.90625485744903
H	-13.28367825551318	-4.54223636617033	-0.94577911544813
H	-11.53774090557341	-6.23383422239855	-0.96114682939391
H	-9.42116700527363	-6.73343337103656	-0.93848670610044
H	-7.24984244984700	-5.63098257824042	-0.92436627403503
H	-6.83047424943098	-1.28480118330758	14.47579214963247
H	-8.61197578906262	0.37292542130279	14.47717223397084
H	-10.78272243318418	0.62506930478503	14.50868324692149
H	-12.92241219644433	-0.53410630445352	14.52536390055068
H	-13.93261754832863	-2.51353224310009	14.48490404058604
H	-13.47783266024047	-4.90944500368936	14.44359570417014
H	-11.83494385027033	-6.32699342640857	14.45452567367550
H	-9.42832892414918	-6.66273789398869	14.48331884246393
H	-7.48566522287993	-5.64614084818070	14.49662439719328
H	-6.44862971964460	-3.44630829592234	14.49277235886328
C	-14.64456626560126	0.16124311578244	7.43430071920314
O	-14.75371602658802	1.27375499917783	7.87846198073434
O	-15.64535510867277	-0.51922875927400	6.85619187838973
H	-16.42385862938469	0.06312909925417	6.82010723015406

C	-14.67693262072270	0.14719205625198	2.47837532391835
O	-15.69094689296795	-0.27370913523489	2.98027724522821
O	-14.56563288123184	1.37005392423107	1.94713280216067
H	-15.42718431419886	1.81213909287311	2.04606521744757
C	-17.01892177402852	1.88060506484345	4.80971159090245
C	-17.75219248210472	2.01909877742585	3.71070530436074
F	-17.53497858836866	1.46977232780834	5.95852067388058
F	-17.23451123049730	2.43282950225679	2.56037760793497
F	-19.03744007061810	1.77229547660797	3.64031257697329
F	-15.72765514860415	2.10270542502343	4.85950288876337

CNTSO₂

C	-6.63516447234851	-3.08932945479535	0.01198795909271
C	-6.89563131136087	-1.74919692448855	0.01399770908022
C	-7.33521368844865	-1.09444862888954	1.22404146244371
C	-8.38091287337259	-0.12088029009868	1.22211633132919
C	-9.06536081339498	0.26717260784620	0.01091469311595
C	-10.42075948415167	0.43169704284567	0.00769641660611
C	-11.18314769251954	0.21899382412976	1.21597391110729
C	-12.43240778070371	-0.47491014017587	1.21360005470098
C	-13.01102287323707	-1.00760909219780	0.00225282805283
C	-13.58713181205957	-2.24546127739992	0.00062743781963
C	-13.62266987673183	-3.03409054564734	1.21012486139180
C	-13.34892202902267	-4.43681935461909	1.20946774984510

C	-13.02011869040664	-5.15316468674412	-0.00062842287917
C	-12.02064529719638	-6.08342542047430	-0.00020921901147
C	-11.28303692558985	-6.35965132860697	1.21028723109725
C	-9.86421282003563	-6.53275223937978	1.21164369912426
C	-9.07996285014402	-6.43935704735766	0.00260693207347
C	-7.88691474325518	-5.77519290206575	0.00508585243209
C	-7.39799960561748	-5.16044542299900	1.21692505819453
C	-6.79503105871723	-3.86451393128669	1.22032108112049
C	-6.73191403445167	-3.14981027882628	2.45304292858421
C	-7.00717476059237	-1.73627909592797	2.45567775962247
C	-7.36915481525354	-1.12059356914472	3.69140649898354
C	-8.40577267852700	-0.15262383871934	3.68946931235828
C	-9.04597989082190	0.16166266950782	2.45226717945153
C	-10.47504863067690	0.33555976183687	2.44931451553103
C	-11.17814935436186	0.18755962015762	3.68407593416849
C	-12.41776558761476	-0.50214418355607	3.68209961301038
C	-12.90978038775882	-1.01736580776884	2.44408841120885
C	-13.51605256498389	-2.32295949665349	2.44233391463885
C	-13.59212443419037	-3.03476623884353	3.67870694024949
C	-13.31941437814576	-4.42680847988991	3.67795359454235
C	-12.98123397948706	-5.05624235663191	2.44097951897139
C	-11.92773994779191	-6.03722899321734	2.44141116668333
C	-11.27624184094436	-6.32929200152280	3.67883715792196
C	-9.86836516622435	-6.50239183691657	3.68035856147057

C	-9.16334703939552	-6.37522680441986	2.44421503410509
C	-7.90491062587175	-5.67638220542919	2.44676055455966
C	-7.42749164236995	-5.14837515634637	3.68513498669117
C	-6.82978814119940	-3.86192116770566	3.68768561323548
C	-6.74403780018557	-3.14643410311195	4.93277849308863
C	-7.02168277545957	-1.75848024829391	4.93427169219956
C	-7.37156189314902	-1.13246058023876	6.17144474074752
C	-8.40658198908604	-0.14153059048742	6.17108610311639
C	-9.06770402148637	0.14906259459611	4.92992897141973
C	-10.47024531710315	0.32570233959819	4.92938846601266
C	-11.18456131773147	0.20023927204386	6.16774107661690
C	-12.43493096553655	-0.49348835190259	6.16513725708247
C	-12.91302225881498	-1.03314544697208	4.92515309674038
C	-13.50836954475873	-2.31676769706822	4.92335375940846
C	-13.61212674110141	-3.03404565382954	6.16097961645901
C	-13.33712914668986	-4.43827659258121	6.15983749685819
C	-12.97020547481539	-5.06141720477274	4.92174755116055
C	-11.93471586004123	-6.02624776515448	4.92220406063419
C	-11.28754814107019	-6.34717244532638	6.16078809853161
C	-9.86716139961682	-6.52253980969304	6.16254002745189
C	-9.15879940520368	-6.36769615373195	4.92547647389518
C	-7.92030630103409	-5.68223024371967	4.92784023702465
C	-7.41751133057319	-5.16615279472526	6.16736219201126
C	-6.81515811669546	-3.86781411663210	6.16943266612482

C	-6.73224074853058	-3.15435472029363	7.40025005663058
C	-7.01452356192251	-1.75191234333566	7.40084821815469
C	-7.37719349723625	-1.12375360610309	8.63755095365845
C	-8.41155203369669	-0.15664922557591	8.63857804194531
C	-9.06159178087384	0.16021947398114	7.40359242171033
C	-10.48102066558674	0.33999548331922	7.40000713986178
C	-11.18810101310774	0.18403003904552	8.63690802421344
C	-12.42544247349242	-0.50442674445574	8.63405039150208
C	-12.92613769431205	-1.02238720138695	7.39497844957442
C	-13.52867539204903	-2.32088824278774	7.39231619126100
C	-13.60091219376117	-3.04200793182873	8.62920091798914
C	-13.32917021614149	-4.43138654108163	8.62785849255608
C	-12.98933268063670	-5.06902538477806	7.38996097763652
C	-11.94201575015590	-6.04483157063084	7.39030954168199
C	-11.28183904673651	-6.33681235411905	8.62888730593175
C	-9.87690357853576	-6.51027490572528	8.63082905092014
C	-9.16227108931785	-6.38685240758145	7.39417911847891
C	-7.91007701361344	-5.69337413703089	7.39665088101842
C	-7.43197221529336	-5.15313538282164	8.63590432714332
C	-6.83505766341992	-3.86957244240314	8.63757542548248
C	-6.75462456559229	-3.14873386888672	9.88046624136319
C	-7.02534818152570	-1.75597391067574	9.88041541217587
C	-7.36268493487996	-1.12558525625130	11.11774372249528
C	-8.41638061316213	-0.14483954583749	11.11843126895408

C	-9.06933283477893	0.14629026579256	9.88170375830065
C	-10.47712098013443	0.31834006269827	9.88099966856823
C	-11.18174292016440	0.19066797778001	11.11753851732928
C	-12.43986293392956	-0.50898712159629	11.11519301460774
C	-12.91693608775619	-1.03868668819145	9.87679154217559
C	-13.51382668294227	-2.32508683365094	9.87421685781000
C	-13.61351951608940	-3.03472474877147	11.11037627854331
C	-13.33753966040537	-4.44757756362641	11.10889887789602
C	-12.97761113316491	-5.06473831048477	9.87158201274442
C	-11.93963863824098	-6.03115122409762	9.87210255340421
C	-11.29901037200006	-6.34504277680432	11.11006709133016
C	-9.87009108705097	-6.51935922223668	11.11215079405008
C	-9.16890275302120	-6.37029502541705	9.87622838780710
C	-7.92902050416612	-5.68177865319918	9.87867719129213
C	-7.43657485552318	-5.16549691427308	11.11646582803356
C	-6.83057707993838	-3.85980834445923	11.11731098980590
C	-6.72254495495285	-3.14800251253563	12.34862561126129
C	-6.99387949089138	-1.74377802590832	12.34872163864515
C	-7.32244390911569	-1.02827201308211	13.55890888905486
C	-8.32247012924678	-0.09833301765387	13.55952074833273
C	-9.06062324475755	0.17691728657191	12.34959387063679
C	-10.48045483002357	0.34929575471374	12.34921766205748
C	-11.26363804598451	0.25521516913998	13.55838996093492
C	-12.45744388385815	-0.40815187890918	13.55648636268265

C	-12.94711310081255	-1.02284898006368	12.34529690588094
C	-13.55092684489064	-2.31920179998038	12.34262054492606
C	-13.70848338372672	-3.09328563284256	13.55112972735360
C	-13.44709519722306	-4.43370095130267	13.54983581886639
C	-13.00964957466099	-5.08910931360413	12.33996115924232
C	-11.96316262401178	-6.06357147451479	12.34052595958211
C	-11.27835255676753	-6.45124820785424	13.55104500504905
C	-9.92263263694850	-6.61569850166389	13.55317111469089
C	-9.16151236157116	-6.40319894599775	12.34476569140326
C	-7.91195921624979	-5.70795298442990	12.34692611539652
C	-7.33463117383505	-5.17348559569844	13.55734350527558
C	-6.75804648994001	-3.93534771054580	13.55823286174503
H	-6.42996864902026	-3.59477560637781	-0.93347573900720
H	-6.89525173536271	-1.20090388073257	-0.92980741408981
H	-8.51830081912506	0.30345199277054	-0.93293840964508
H	-10.93899274976951	0.59733233951507	-0.93857361701956
H	-12.87403904640544	-0.47843293913907	-0.94255107739804
H	-13.90308314105169	-2.68877549103054	-0.94545673633200
H	-13.48034156307457	-4.86072459699076	-0.94621618239071
H	-11.69556199629561	-6.52187711691939	-0.94546642245499
H	-9.49924996410142	-6.78524185134940	-0.94397355635486
H	-7.36884761272481	-5.59952455283555	-0.93945863986848
H	-6.86143984530136	-1.32048398380084	14.50416216676021
H	-8.64724257887578	0.33945699406395	14.50515357253217

H	-10.84377699252592	0.60027743471526	14.50500679697395
H	-12.97435523467378	-0.58412876325232	14.50158631116740
H	-13.91045899797585	-2.58744058590484	14.49705490528187
H	-13.44351970641014	-4.98012352680091	14.49473029298225
H	-11.82398732292501	-6.48619532684492	14.49577349568101
H	-9.40391731185146	-6.77979836764370	14.49945132723954
H	-7.47236103937499	-5.70096804041256	14.50300626230212
H	-6.44341807438339	-3.49117460154112	14.50428877337079
S	-6.31561378668723	1.89894948710970	6.25775988778199
O	-5.66803615271190	1.46411245954126	5.01271207578895
O	-5.73239898788336	1.44266597223140	7.52741193833138

CNTPFOS

C	-6.48056397864906	-2.85397528152444	-0.09162102608656
C	-6.83260661691846	-1.53495902770663	-0.09592790538013
C	-7.31153250852182	-0.90045426376916	1.11119442350846
C	-8.41816452836528	0.00438065160010	1.11061068989938
C	-9.13479024803035	0.33752403438341	-0.09785240154467
C	-10.49791240142580	0.41870584274630	-0.09004286401624
C	-11.23617427348009	0.17027220989289	1.12599226193656
C	-12.44195889030591	-0.59770463315996	1.13742443414958
C	-12.99829810766232	-1.16986392810068	-0.06589748888027
C	-13.49987825212163	-2.43991798788344	-0.05692451601907
C	-13.47749166579263	-3.22303663849564	1.15602356333402

C	-13.12052265562211	-4.60736669074387	1.15926836569254
C	-12.75701721458576	-5.30703938569305	-0.05042048462320
C	-11.70123279392699	-6.17308525227106	-0.05442071736377
C	-10.93939283129756	-6.39737017354050	1.15144549537160
C	-9.51168518436045	-6.47835179686038	1.14354108702053
C	-8.74072649925199	-6.33841327061476	-0.06891111704413
C	-7.58651165438087	-5.60741611117712	-0.07589324889970
C	-7.13061568112021	-4.95941838530503	1.13012871203058
C	-6.58800150613890	-3.63231542971437	1.12333225260217
C	-6.57512196827422	-2.90252821263848	2.35183642851215
C	-6.93417858802447	-1.50686890447063	2.34522101695585
C	-7.32654195875320	-0.90445260820708	3.57975771090500
C	-8.42238217873143	-0.00455232549166	3.58035153732379
C	-9.09042399506440	0.25490392798873	2.34448480105546
C	-10.52750875981443	0.33860882815383	2.35245488702545
C	-11.20850508607789	0.15329484463743	3.59521527330790
C	-12.40276774171467	-0.61181166186251	3.60602776593870
C	-12.87375064539392	-1.16185008592535	2.37440986102443
C	-13.40174590308384	-2.50099431400126	2.38383979889115
C	-13.42484314481027	-3.20985063350539	3.62413461555050
C	-13.07180066481154	-4.58351578293170	3.62761549268115
C	-12.70672516241015	-5.19760559250020	2.39011517531364
C	-11.59506879754360	-6.11223675913387	2.38618318652431
C	-10.91933479619401	-6.35943865446614	3.62078721537617

C	-9.50367499642190	-6.44200585786786	3.61273924919151
C	-8.81618702959178	-6.27280986246395	2.37134334042561
C	-7.60696181606130	-5.49298199652403	2.36347398347600
C	-7.16415278814443	-4.92599742762470	3.59698537598621
C	-6.64678996047395	-3.60762887594986	3.59129777840417
C	-6.59945123950695	-2.87996951199822	4.83130090508834
C	-6.93529112405320	-1.50833874002016	4.82628012566501
C	-7.29942668915968	-0.88281515801904	6.06350762898341
C	-8.40359249365127	0.02744365174429	6.06444627257935
C	-9.08940194100215	0.26767574507767	4.82775430393219
C	-10.50244285942674	0.34669439652614	4.83482371713550
C	-11.19907344181429	0.18437488207255	6.07779252130859
C	-12.40325976212718	-0.58935346785893	6.08805615613721
C	-12.85613682419254	-1.16457327189564	4.85548353392077
C	-13.37431267510200	-2.48176176822917	4.86463182169903
C	-13.42649359078670	-3.19714643367451	6.10584562560560
C	-13.07017005827679	-4.58344246026082	6.10990695641131
C	-12.67675772725589	-5.19036775015974	4.87188475777991
C	-11.58680926157704	-6.09341236685278	4.86869358606127
C	-10.91260966413764	-6.36822675167316	6.10417397284799
C	-9.48397520262977	-6.45281530528872	6.09593764400448
C	-8.79743811786688	-6.25543042974392	4.85288459703571
C	-7.61131390575608	-5.48513185985385	4.84433701588734
C	-7.13842786426063	-4.92860136242023	6.07633685288881

C	-6.62143974546714	-3.59659428880224	6.06982251560053
C	-6.55780961312750	-2.87616314702644	7.29599487893436
C	-6.90810157749363	-1.48820596873892	7.29285674103762
C	-7.30240630076032	-0.88420131941238	8.53159658804961
C	-8.39416626859187	0.01686356296207	8.53353238823489
C	-9.06771098633499	0.29254741554820	7.29748974456799
C	-10.49685159523890	0.37344756258331	7.30394079442302
C	-11.18558231162612	0.17924559411112	8.54650021354587
C	-12.37692894523491	-0.58520444704263	8.55606835810935
C	-12.85309498801500	-1.14049306500867	7.32320348738790
C	-13.37545096799570	-2.47310630813357	7.33234066001428
C	-13.39579390547311	-3.19006362130621	8.57374832632631
C	-13.04241773575448	-4.56078139597402	8.57819267626534
C	-12.67602927444504	-5.18517665555709	7.34069479166868
C	-11.57359015370447	-6.09805858481400	7.33796606322011
C	-10.88610036635755	-6.34105607995152	8.57300467079735
C	-9.47320771643720	-6.42679493415036	8.56445819211487
C	-8.77979137055924	-6.26311511239143	7.32090879745424
C	-7.57833998238588	-5.48531202279757	7.31070718173991
C	-7.12427301712552	-4.91016775290759	8.54234920254772
C	-6.60608110275831	-3.59346960181364	8.53545276321211
C	-6.55328592537273	-2.86789493093732	9.77690292490131
C	-6.90853688895754	-1.49404471230666	9.77480109621799
C	-7.27750799534378	-0.88309367122476	11.01191638346991

C	-8.3874460077756	0.03359198132266	11.01460497672209
C	-9.06273578397135	0.28220511428144	9.78008946431444
C	-10.47861693725230	0.36642065151223	9.78646886509225
C	-11.16693768556699	0.20246842117017	11.02750529842747
C	-12.37902319808328	-0.57411786328386	11.03706614075020
C	-12.82830494309436	-1.14061333823124	9.80489558128073
C	-13.34460214265736	-2.46161385255248	9.81398292680553
C	-13.39202246354273	-3.16841282071984	11.05470004453565
C	-13.02922844714161	-4.56145329646184	11.05937383648998
C	-12.64335973163467	-5.16396452945282	9.82283538693570
C	-11.54964060953673	-6.06693703506018	9.82046918646586
C	-10.87934062601256	-6.33233208813451	11.05438870829529
C	-9.44241153447567	-6.42064175234953	11.04498463923768
C	-8.76351330579387	-6.23494128898906	9.80222143866733
C	-7.56979186670861	-5.46863690456790	9.79086846866828
C	-7.09714127669538	-4.92024700295753	11.02206568702575
C	-6.57706674756084	-3.57843759938865	11.01510418901811
C	-6.50757636419296	-2.85894674145145	12.24452268730085
C	-6.86786219839983	-1.47685637522346	12.24334789710936
C	-7.23286707920139	-0.77855900855368	13.45338492611406
C	-8.28467954565422	0.09209572608534	13.45596403015208
C	-9.04314972400496	0.32128340750399	12.24846172038136
C	-10.46979705624062	0.40975266409195	12.25474491186616
C	-11.24008518113541	0.27740252512877	13.46904860959096

C	-12.39039860366494	-0.45812534665861	13.47808646752099
C	-12.84624659053437	-1.11106557972783	12.27333500989148
C	-13.36584976368959	-2.44275113690714	12.28245195504499
C	-13.46550813563551	-3.21771307558601	13.49676564307606
C	-13.11969773627853	-4.53870213898559	13.50127851278381
C	-12.65167337636411	-5.17333249297170	12.29159869270489
C	-11.54793024540383	-6.08204516330521	12.28930805717245
C	-10.83013595222005	-6.41911045943528	13.49623616749863
C	-9.46717009917965	-6.50366477619532	13.48710919068898
C	-8.73016051586904	-6.25528016612570	12.27041249362913
C	-7.52368284434152	-5.48894715334792	12.25820044246809
C	-6.96181488974261	-4.92004557397241	13.46147233170852
C	-6.47311741011859	-3.64581232812536	13.45523996600033
H	-6.24386377155265	-3.34939609387266	-1.03503620410560
H	-6.87002705117249	-0.99440611239043	-1.04352625962673
H	-8.59933010612492	0.39748117399516	-1.04717074247594
H	-11.03286559351713	0.54294584656832	-1.03330971395131
H	-12.90174839545042	-0.63822194891389	-1.01431389561526
H	-13.79747585526639	-2.90571182705256	-0.99813440274740
H	-13.24110109016050	-5.04751971516514	-0.99369683069905
H	-11.35581002199666	-6.59389599190932	-1.00051128775510
H	-9.14362623298457	-6.70934206099489	-1.01311503797057
H	-7.08468481927432	-5.40618708785769	-1.02385202714429
H	-6.75295528305436	-1.04244632149256	14.39761252823010

H	-8.63058020680897	0.51236975563964	14.40205165491116
H	-10.83793595318619	0.65568331540147	14.41065718680377
H	-12.89199114019755	-0.65792403470662	14.42670962271997
H	-13.69208736331435	-2.71967240908610	14.44123706890828
H	-13.07501293163392	-5.07809235855105	14.44914596146489
H	-11.36415189363120	-6.47904435448001	14.44631065319384
H	-8.93149574281828	-6.62923185068385	14.42982580694489
H	-7.04113100655973	-5.46082245078250	14.40628972115784
H	-6.16375613513698	-3.18334802890439	14.39425325536947
O	-1.96227898235899	-6.61404900619371	2.72173047915790
F	-4.26491121907507	-5.74431336886478	9.76347570916363
F	-3.99514653033668	-6.27955534522060	12.34774156963036
F	-4.36092393925280	-5.45127483144758	7.12473992493761
F	-4.45749774338220	-6.17659040637616	4.56675624047879
F	-1.83865012742256	-6.79644366426682	10.90657149338668
F	-2.46847581385458	-7.01059047361760	8.33182598806393
F	-2.25545265414237	-6.91963592339099	5.74368670714809
F	-1.47885701022440	-6.45497721414328	13.61273027755220
O	-4.01188031882532	-5.48576912780200	1.95225535346862
S	-2.65904339412776	-5.35199758237125	2.83452979349794
C	-3.05316718989014	-5.16601249790580	9.67262437903145
C	-3.06852653249752	-5.31114003215008	12.26459571787155
C	-3.06015500083210	-5.09767440386950	7.07314457238603
C	-3.45789947743284	-5.29238378894169	4.54264640649594

C	-2.23761421855166	-5.51465520780619	10.95947195849164
C	-2.37535039185323	-5.67195654721272	8.35120416515541
C	-2.47126720508379	-5.59911136656365	5.70787959386975
C	-2.22562539189803	-5.35239314024384	13.57202318122444
F	-3.05936956628627	-5.35531414252122	14.61174870442975
H	-4.42993193422643	-4.61101679897686	1.80599694338586
F	-3.67554749150523	-4.11112369174397	12.21816425016696
F	-3.20315799928909	-3.83290713140008	9.62559140539310
F	-2.95859980313098	-3.76039785658183	7.08655933114371
F	-3.94306905968665	-4.04886135605030	4.67391386980679
F	-1.15522058202218	-4.71734085995882	11.00790389885963
F	-1.30958655207348	-4.96352502698541	5.48157064278774
F	-1.43715184331875	-4.28537406394068	13.65874704552737
F	-1.07939883935077	-5.31204455962033	8.34298159314063
O	-2.04981932434392	-4.05421271062230	2.60639575092270

CNTPFOA

C	-6.74656033011054	-3.48277325159148	-0.20670804665537
C	-6.87236317375784	-2.12300783518608	-0.18838278619694
C	-7.20314450461183	-1.43846670357181	1.03935584115791
C	-8.14768422301845	-0.36538124845623	1.07996548930359
C	-8.83111862679414	0.10015240066720	-0.10368000379971
C	-10.16191011253825	0.40365498735273	-0.05681561370301
C	-10.89880052274245	0.26348049162720	1.17712256732101

C	-12.21336032159380	-0.29744014904303	1.21730242814516
C	-12.88605990641323	-0.75864501655480	0.02569710561929
C	-13.58420425746833	-1.93207150356035	0.03954454864865
C	-13.65518121789605	-2.72269079097591	1.24585995041431
C	-13.52178521615524	-4.14601819106312	1.22844796225625
C	-13.30930247256199	-4.88080272716086	0.00371009307888
C	-12.40879474217227	-5.90655527269000	-0.03700805820831
C	-11.66064659627236	-6.26656567223768	1.14432058140748
C	-10.26760741071259	-6.58429483850534	1.09306192377972
C	-9.52168781771147	-6.56311014174061	-0.14323950963819
C	-8.26620271820735	-6.02727429984471	-0.18121936793108
C	-7.67252798283739	-5.47718190825941	1.01463576300232
C	-6.94046373963165	-4.24903145663504	1.00205127880754
C	-6.76315788441522	-3.55470354547373	2.23520534915772
C	-6.90318223949258	-2.12248630062634	2.25397434247253
C	-7.16219583476673	-1.48721220835047	3.50573391133361
C	-8.09256995307524	-0.41998211757474	3.54648043374117
C	-8.73758066771135	-0.02815119023755	2.33401844052014
C	-10.13935500744599	0.29490725526488	2.38398516663013
C	-10.80829427721557	0.21062467258457	3.64375054994224
C	-12.11185727796146	-0.34654456097366	3.68367254149391
C	-12.69875741942198	-0.79813012880769	2.46186246051649
C	-13.43333476475514	-2.03617485360919	2.47640952078107
C	-13.53505277123006	-2.74715905725050	3.71159362402497

C	-13.40222721537531	-4.15906140743102	3.69414649364781
C	-13.17350252901201	-4.80891718397328	2.44248423436530
C	-12.22449722111920	-5.89045385571800	2.39950924673000
C	-11.56233873589651	-6.25767360139001	3.61093062848641
C	-10.18074091422177	-6.57404823709027	3.56022752768548
C	-9.51068397915591	-6.51062157157510	2.29987078981956
C	-8.18656223195155	-5.94702293591851	2.25980799316839
C	-7.61335731057750	-5.48124059515605	3.48277526826335
C	-6.88861511126583	-4.26224504049477	3.46999295750042
C	-6.68762130436667	-3.56821430616205	4.71464904327983
C	-6.82894756668652	-2.16058210181731	4.73232198310993
C	-7.05884207736911	-1.50343820502347	5.98351986245767
C	-7.99993065942913	-0.42773243814159	6.02494252890981
C	-8.66812085999565	-0.05552889638675	4.81355190945850
C	-10.04568777088858	0.26522105635060	4.86315536844285
C	-10.72425071973439	0.20803014642049	6.12452689603723
C	-12.03947394685206	-0.35551597476588	6.16516907859692
C	-12.61478424082226	-0.83320336183989	4.94179869624000
C	-13.33554935553041	-2.05142055631396	4.95593696221891
C	-13.46596657221416	-2.76465187778283	6.19286606193434
C	-13.33182678897609	-4.18963295307711	6.17499159580693
C	-13.07426922700608	-4.83579042570988	4.92135758646207
C	-12.14180137217217	-5.89987319866821	4.87903101796780
C	-11.48756971660707	-6.29633656072598	6.09130898941024

C	-10.09336798015943	-6.61656901628277	6.04025305954728
C	-9.41720771394998	-6.52445812187943	4.77938194543451
C	-8.11499574971775	-5.97086535938339	4.74019533441872
C	-7.51814770142861	-5.51923731997626	5.96317506368672
C	-6.78623543408280	-4.28888379530723	5.95000521313207
C	-6.58944777055513	-3.59679038369298	7.18036475543673
C	-6.72705726168438	-2.17241239765935	7.19713064015965
C	-6.98737533975001	-1.52736827111240	8.44949940482125
C	-7.91928858715710	-0.46429288630637	8.48997288072385
C	-8.57189771883099	-0.06592928458291	7.27839514560999
C	-9.96460361145122	0.25885598788498	7.32935727974097
C	-10.63971706066700	0.16958383082970	8.59059233149514
C	-11.93991739587454	-0.38818239542818	8.63122826228729
C	-12.53741750201938	-0.84160626390833	7.40917979283727
C	-13.26587950408987	-2.07355430907528	7.42339173780264
C	-13.36434819654752	-2.79413497685390	8.65904760097575
C	-13.23244398106472	-4.20328521763711	8.64121815671854
C	-13.00488453889258	-4.86218554168874	7.38829450422031
C	-12.06299537193364	-5.93889629458999	7.34536518056402
C	-11.39260583484205	-6.30874954166876	8.55731803299784
C	-10.01414848118413	-6.62607048918315	8.50678854745967
C	-9.33483218366078	-6.56565346621454	7.24572228962732
C	-8.01863723395597	-6.00459006543149	7.20630895463444
C	-7.44390187384343	-5.52741600715014	8.43018395609160

C	-6.72159858459369	-4.31009448052041	8.41725494222787
C	-6.52682815471162	-3.61374475796497	9.66221406613959
C	-6.65893584098260	-2.20123770463984	9.67815365887206
C	-6.89160006750641	-1.55327122020368	10.92975169261257
C	-7.83325952590241	-0.46557702068023	10.96982522981884
C	-8.49363166538745	-0.09889899300236	9.75702255672662
C	-9.87464570189049	0.21996720469013	9.80881068970475
C	-10.54381047777986	0.15956004281039	11.06951445393158
C	-11.86534317161860	-0.40937230092803	11.11101385113023
C	-12.43806277514427	-0.87887898018672	9.88917049363046
C	-13.15990745949256	-2.09980799298303	9.90337935164660
C	-13.28298679617318	-2.80593385925283	11.13929858855723
C	-13.15082082396824	-4.23915132570667	11.12102960276175
C	-12.90197915617724	-4.87936767135241	9.86815453349010
C	-11.96973509395125	-5.94753276054422	9.82547874997670
C	-11.32127808133206	-6.33778829406677	11.03716627978286
C	-9.91943303039464	-6.66072804331155	10.98576756578005
C	-9.25127867229708	-6.57306612220184	9.72604174298727
C	-7.94738830893728	-6.01585017254382	9.68696977313347
C	-7.36109568626150	-5.56569994152948	10.90931722615955
C	-6.62973978183797	-4.32604615021092	10.89653230304856
C	-6.41235662359462	-3.64057042223778	12.12879900510300
C	-6.54853482959723	-2.21904730394770	12.14417806961453
C	-6.76273576666395	-1.48402604134933	13.36956257945599

C	-7.64893749146980	-0.43987364604829	13.40612037389648
C	-8.39451171847059	-0.07770242940959	12.22241766628169
C	-9.78659392329050	0.24034118576439	12.27586147476083
C	-10.53289727315731	0.22232962222749	13.51209847696049
C	-11.78490567293273	-0.32170794295650	13.55129530588922
C	-12.37592021953047	-0.87931134663411	12.35730320239703
C	-13.10299631827979	-2.11005611039969	12.37187543293777
C	-13.29242598305952	-2.87467943987565	13.58201081919577
C	-13.16799038030205	-4.23449274546036	13.56462661279913
C	-12.84536845265262	-4.92139946048252	12.33611429124929
C	-11.90719965527093	-5.99905288146585	12.29296759375391
C	-11.22415541775058	-6.46926628188724	13.47526343947184
C	-9.89444729390796	-6.77597064256012	13.42667967329700
C	-9.15872931445119	-6.63204859906839	12.19232636789163
C	-7.84532264710785	-6.06983529607507	12.15292529165108
C	-7.17297826196959	-5.60943549760814	13.34529097387288
C	-6.47886555977671	-4.43372271703998	13.33383071158761
H	-6.62717424871000	-3.99736916171351	-1.16193489005697
H	-6.85050879237595	-1.56980278891084	-1.12908626573933
H	-8.31832588044435	0.08601596332772	-1.06714544014038
H	-10.69358313093444	0.62711280462565	-0.98355156117445
H	-12.72999620485059	-0.23850916429365	-0.92117353201425
H	-13.97670986666992	-2.33375754322224	-0.89640996661417
H	-13.77066141738105	-4.53522744670683	-0.92318002226512

H	-12.16311188227374	-6.36662339467822	-0.99586067615833
H	-10.00834304848659	-6.85527659538975	-1.07555340322262
H	-7.76711499520832	-5.89821617933212	-1.14337209532187
H	-6.31458140408618	-1.83807960664630	14.30010303657174
H	-7.89306438906278	0.02307706550677	14.36405970152703
H	-10.04966232082125	0.52418072879263	14.44320865022725
H	-12.28436556026255	-0.44806329344261	14.51363970643051
H	-13.40668262429993	-2.35883875089132	14.53717923789358
H	-13.18486380105494	-4.78634436767725	14.50623361020251
H	-11.73680527729289	-6.45710154943512	14.43886250302563
H	-9.36241719378040	-7.00451419952030	14.35200312156760
H	-7.32533953321169	-6.13322461053090	14.29076895215373
H	-6.08509933316305	-4.03423793707361	14.27034944649424
F	-5.11209615778568	2.86857998969995	8.98611901393972
F	-4.12567624858708	2.64249823975435	6.36436183736615
F	-3.38785198934170	1.89062305445582	3.90570000800503
O	-5.62418176983556	2.59952594313108	12.15575315226523
F	-3.33633084234847	3.28827260416916	10.77316927542044
F	-2.42737810563269	2.11275860757949	8.20688138063152
F	-2.17039589623472	0.57900571055051	5.85008569058565
F	-2.15883253326812	-0.46856231429441	3.27930169096073
C	-4.80357711403250	1.77649670897149	11.86247726314427
C	-4.46274165122086	1.75490532007547	9.35953684955304
C	-4.18567243092696	1.37595245179137	6.80639139413351

C	-3.93491529063443	0.72674659466861	4.29458531067337
F	-3.87830749550724	0.03030372268071	2.05215809948313
C	-3.76496961123242	2.01773405416682	10.73481272483911
C	-3.50448240255328	1.30925396682698	8.21765718034296
C	-3.50555903911600	0.43246393439309	5.76406402181063
C	-3.48668339780596	-0.35474200144144	3.26517364181836
F	-5.36396716293090	0.76486940521145	9.54547737588044
F	-5.27549875564553	0.82848749541178	4.23825179922201
F	-5.47620033107893	1.01362792839260	6.91956725017269
H	-5.44296462125847	0.35588994211887	12.94161804962996
O	-4.67166660086139	0.55947190715631	12.36928200953436
F	-4.02463362717892	-1.54141844848490	3.53130331266382
F	-2.70456236317821	1.19587428882349	10.86716213533116
F	-3.11685174242850	0.04516075698247	8.46095898878690
F	-3.83311481015674	-0.83747046356187	6.06229443838372

ffCNTPFOS

C	-6.54831218920067	-2.04469895622987	0.32034137794124
C	-7.17677360544069	-0.82971429450865	0.26941510618170
C	-7.89743189718492	-0.33185382441840	1.41354210357314
C	-9.14793175478858	0.33573461420930	1.29967807519941
C	-9.78083322537099	0.57151486026118	0.02304579540933
C	-11.13009490414174	0.45024446419458	-0.11093666004805
C	-11.96750047087848	0.09930847328697	1.02311744612961

C	-13.12060381704318	-0.65385274905623	0.88445391932701
C	-13.47889486667672	-1.30000016210343	-0.36859507519254
C	-13.73513581545209	-2.63436041204166	-0.36779010339110
C	-13.57964014202215	-3.39111798780443	0.87967420481571
C	-12.87860400203651	-4.65709373055350	0.91072869112926
C	-12.26439449884974	-5.21145734109727	-0.25278312399121
C	-11.08943866368685	-5.92371119739003	-0.15914650199519
C	-10.45320769880917	-6.11842982259348	1.10536172388509
C	-9.01668398989741	-6.06171368001131	1.24926722136446
C	-8.15025834077807	-5.82327044332235	0.13015937106375
C	-7.10620059315588	-4.94119500102262	0.24195130363774
C	-6.87531861621522	-4.25057728387695	1.47999558785821
C	-6.60799074922855	-2.84005778124904	1.51868663110513
C	-6.87059407542935	-2.14276114645948	2.73476855768988
C	-7.51595724659105	-0.86809028718579	2.68507967927390
C	-8.14089096876777	-0.37391992051744	3.87111490055301
C	-9.39429816444746	0.29342581034932	3.76069313063049
C	-9.98926515597301	0.43393001517072	2.45985571849385
C	-11.39894253337106	0.36318898842179	2.33061447770447
C	-12.18887580688901	0.11242122894910	3.49914025415638
C	-13.35974152601748	-0.67253779346251	3.40721354835046
C	-13.89920443882091	-1.18961672414036	2.07761674453940
C	-13.79837386501785	-2.72349838935038	2.07923590515650
C	-13.73152326850304	-3.41201688381945	3.32762399735440

C	-13.06633375317564	-4.67372081222235	3.36921266973861
C	-12.47404797530655	-5.18046515462973	2.17100642935185
C	-11.25261116868870	-5.92675643493282	2.26969403485127
C	-10.68130952601649	-6.13264605665563	3.56691246973473
C	-9.26677357372381	-6.06228362625305	3.70778381121155
C	-8.48081935587513	-5.79000584315315	2.53931323790020
C	-7.38606252333214	-4.86975619918174	2.65891223932402
C	-7.15442908168254	-4.26241030766113	3.93449644784262
C	-6.88636037879850	-2.86513088395275	3.97412919288011
C	-7.09540911441978	-2.16245427612887	5.19891059626119
C	-7.74349554288258	-0.88625878594440	5.14561173076223
C	-8.35704333250006	-0.37649870758542	6.32952073590216
C	-9.60865462044113	0.29831640877134	6.21839245027680
C	-10.20180743695457	0.43792474718673	4.92742223144952
C	-11.62294831562103	0.33025688259681	4.79973114509089
C	-12.41583666127609	0.08382912854166	5.97152116789965
C	-13.58144590545034	-0.70139457365412	5.84372212039067
C	-13.84649232031612	-1.28102638387156	4.58153617250295
C	-14.03735562174844	-2.73776812654413	4.54280461482719
C	-13.96980053654996	-3.44653738351436	5.77576783099486
C	-13.30850123598335	-4.71941229185364	5.81405679243070
C	-12.70858519513985	-5.23226771956975	4.62919256344285
C	-11.49377108851212	-5.98094967170660	4.73251014760442
C	-10.92132031391207	-6.19002277759662	6.02327214494669

C	-9.50120852674319	-6.10906362785500	6.16448870186093
C	-8.71504811932644	-5.83071913479406	5.00502645400914
C	-7.63436873776578	-4.89792307689815	5.12290717580034
C	-7.39215070283893	-4.28829648340195	6.39199203440630
C	-7.11483966657551	-2.88614521245373	6.42995380254985
C	-7.33531647427245	-2.17783926328635	7.65421734610999
C	-7.95565662020827	-0.89362874285815	7.60222317214357
C	-8.57567769495621	-0.38393478191174	8.78318953258287
C	-9.82118255375375	0.29202106933839	8.67444448460685
C	-10.43235563189416	0.42905426727160	7.38477797248828
C	-11.83894868008337	0.33759789943961	7.26284683130056
C	-12.60767331199548	0.02410947922506	8.43736495634793
C	-13.75342888607945	-0.76976201856948	8.35714362842538
C	-14.34496722436879	-1.25073288620923	7.04456601900694
C	-14.24620744458857	-2.79068020319031	7.01176760585290
C	-14.21369277940901	-3.49641579745233	8.21614918841908
C	-13.56169827238423	-4.77792715727738	8.26133906116603
C	-12.95472526298436	-5.28146206984534	7.07705427760142
C	-11.73937021363258	-6.03296898412934	7.18481944113850
C	-11.17064162045413	-6.22540530340398	8.47476783295656
C	-9.75091937458768	-6.12518326810715	8.61920391702107
C	-8.95832867172029	-5.85263338453326	7.46375186495688
C	-7.87787293960814	-4.92142956076284	7.58113605674201
C	-7.64679368359408	-4.30415633862361	8.84695096189568

C	-7.36774508942161	-2.90278574776817	8.88462598598496
C	-7.58692080805409	-2.19536295965255	10.11057343822283
C	-8.19402587340288	-0.91354080628885	10.05986429745816
C	-8.78093379065354	-0.38355294278175	11.25454579960338
C	-10.02817965468889	0.32380987481974	11.14539911913352
C	-10.62720301973107	0.43660831685102	9.84829236467233
C	-12.02918413036510	0.29722776885409	9.73206305032004
C	-12.79136260659530	0.05726018758560	10.91605931471632
C	-13.88539308187198	-0.86659589753500	10.82314078108205
C	-14.18082225620085	-1.43466899233517	9.54496442341415
C	-14.46123613590666	-2.82603112521103	9.48333531452238
C	-14.47662624567333	-3.56815427643285	10.69642683126446
C	-13.84683112999761	-4.86954579128835	10.72679164139278
C	-13.20747490696736	-5.33728067599689	9.52678679061168
C	-11.99062007550386	-6.06107093061407	9.63574326706692
C	-11.42766882864349	-6.26115883482819	10.93788471102913
C	-10.00276001098722	-6.14291965658819	11.08542926493691
C	-9.21993612400952	-5.85129496115527	9.91981322280442
C	-8.15212820105302	-4.92293772857508	10.03557405286944
C	-7.91252793856010	-4.31746463963524	11.31339741630674
C	-7.61358911935346	-2.91168123689367	11.35238155999508
C	-7.77815769029602	-2.20127633296128	12.57247307403904
C	-8.37307980487112	-0.88551018061501	12.52197552617974
C	-8.95897585475362	-0.27007860825820	13.67796367187288

C	-10.14633163716857	0.40943649567179	13.57365364008061
C	-10.82088636875879	0.51428465055710	12.31050422226085
C	-12.24985271924317	0.37132842991474	12.19439224504019
C	-13.07926045509485	0.09434191373220	13.33343884131298
C	-14.10020160094875	-0.81782396212381	13.24413201002598
C	-14.36630868591991	-1.49392861267465	12.00434337083411
C	-14.68617584739442	-2.89531606842723	11.93931890295736
C	-14.76401290936139	-3.71186449063644	13.11879117285701
C	-14.20734481928817	-4.96290435115496	13.13546832043362
C	-13.51931929848812	-5.45851306007363	11.97166164979316
C	-12.25978284285921	-6.16441022359342	12.08589604858577
C	-11.63602469254656	-6.39612726963655	13.35434435978176
C	-10.27480505642926	-6.26842001667407	13.49640861204059
C	-9.45591803837116	-5.91257758849767	12.37712965061578
C	-8.37208931263413	-4.96073813503651	12.49530415507702
C	-8.05767528736343	-4.32210070677216	13.73983943464082
C	-7.76999253750863	-2.97992327895949	13.77671047113363
H	-6.13217708192625	-2.46978185848306	-0.59500370144250
H	-7.24497072534458	-0.30562744720437	-0.68562309384757
H	-9.16626017512183	0.73813879518268	-0.86386101148646
H	-11.58018957512342	0.52105975169174	-1.10303768052385
H	-13.44174091351550	-0.75120159336539	-1.31403435109800
H	-13.94333717859723	-3.16190538336614	-1.30038418109511
H	-12.64819461254264	-4.95439093120513	-1.24098813470209

H	-10.57133199530895	-6.20721337762359	-1.07669523257140
H	-8.40899659353621	-6.21886408544048	-0.85363231425328
H	-6.55629685957722	-4.65096194176940	-0.65525693366938
H	-8.54151597147403	-0.46238311172632	14.66802778224498
H	-10.64564532604521	0.74549341017095	14.48430087892450
H	-12.80868127949219	0.49224720919697	14.31313798277760
H	-14.61738354731014	-1.12761897911971	14.15432640824391
H	-15.14761541154902	-3.28613308196844	14.04835338106920
H	-14.16410967300385	-5.51829101190621	14.07373125110716
H	-12.25008049086100	-6.52332425738698	14.24714628732832
H	-9.84398148372698	-6.29463781408815	14.49895233367885
H	-8.19859717800774	-4.85992680373029	14.67901499834880
H	-7.68736567266281	-2.48337471055230	14.74521510576372
C	-15.83419359904949	-0.81750773691166	6.98120233121995
O	-16.40576785305857	-0.19577242702598	7.83964246888844
O	-16.42219454063784	-1.22630183527784	5.84764485883759
H	-17.33370759484404	-0.89022293242091	5.84288148813291
C	-15.38442155005214	-0.74725256216244	2.00971277467086
O	-16.31660947153279	-1.39607329075479	2.41018503096046
O	-15.50573807031589	0.48838613462954	1.50066487911450
H	-16.44641715006523	0.72813714347129	1.55422402206048
O	-10.66083600903718	3.44500293200495	8.91580612350390
F	-13.88043757859337	4.21839614115423	5.86866478422748
F	-16.07611108856287	4.08694444598677	4.36561275110996

F	-12.25947402839194	5.33673764042729	7.50478251369880
F	-18.43797055438773	3.65375436821121	3.05177325299268
F	-13.45319344265628	2.66015247455605	8.09119059549020
F	-15.12534370683441	1.95614516185793	6.11309981959517
F	-16.58240239726858	1.58453453164891	3.89227699411772
F	-18.36987303472586	1.33406018382264	1.82341053119683
O	-10.97320944097982	5.46307022046578	10.29358586803713
S	-11.65689483951058	4.09485160602245	9.73503743182553
C	-12.92450580419239	4.89861066345522	8.57111576021073
C	-14.77941851755515	4.15693267491602	6.86179089148721
C	-16.77279901609893	3.45542737823587	5.32412105837128
C	-18.71937893354067	2.58697140626987	3.82062895918156
C	-14.03581815387475	3.86786352498429	8.20200779423783
C	-15.81819778890529	3.04623067058597	6.49380635283180
C	-17.47322557904667	2.21512833161570	4.67842881300391
C	-19.19000617376335	1.43319621583762	2.88110818979108
F	-20.40908345577163	1.70714986987739	2.43445125976143
H	-11.50233255483168	5.79060992571953	11.04332669884494
F	-15.40561169608062	5.34506775880364	6.97655207834354
F	-17.71173800146114	4.28667808734213	5.80836607652149
F	-13.47034200282505	5.94110634482889	9.21359789602543
F	-19.73641623227754	2.88498320038143	4.64208706829633
F	-14.91456005093850	3.85306489624734	9.21160291874914
F	-16.57222965370848	2.75809751948193	7.55969077700030

F	-17.88151320566547	1.37458794904574	5.64857805798502
F	-19.20849549764465	0.27296293313189	3.52728187939588
O	-12.39085093682150	3.46068891109360	10.81831784359621

ffCNTPAN

C	-6.57553914435594	-3.11739501610120	-0.01019055212266
C	-6.95188467246388	-1.80227934180230	-0.04572351326498
C	-7.45913216935636	-1.15496103385001	1.13773991401526
C	-8.55240692738930	-0.24734326282406	1.10498936247799
C	-9.23678960982581	0.09585744654611	-0.12019293713703
C	-10.58753065128104	0.27115827240010	-0.13739954490583
C	-11.37976686595337	0.12890145979255	1.07252938442319
C	-12.68291462360764	-0.34697068176914	1.05089303192341
C	-13.26651559603035	-0.92515888702082	-0.15611914740988
C	-13.72597860434753	-2.20153336938363	-0.11176945824978
C	-13.60315930827632	-2.97180827194455	1.13123599470902
C	-13.18747309809646	-4.35697525534447	1.13834412348014
C	-12.79945685345272	-5.03820167381277	-0.05477987735451
C	-11.80244429341678	-5.98733371405807	-0.03188142596492
C	-11.12493082154602	-6.30252903717887	1.18673096389174
C	-9.70194075871379	-6.54472848984907	1.21916526012800
C	-8.89717941326683	-6.50316304040532	0.03047858255388
C	-7.69340044720018	-5.84756451424976	0.03660319431173
C	-7.23284831670774	-5.19905872075671	1.23340168439883

C	-6.69208900538550	-3.87028467124967	1.21169852807427
C	-6.70822799524479	-3.11987336090114	2.42504541231243
C	-7.08578405476205	-1.74184950925331	2.39097137028395
C	-7.48989939354303	-1.11513415741157	3.60964405585096
C	-8.58117789431516	-0.19998793914321	3.58109048664833
C	-9.24728340905249	0.04335634028178	2.32814447173358
C	-10.64545882766851	0.26808752057942	2.31678708033120
C	-11.35824551178915	0.19387106682492	3.55553500035047
C	-12.65753635604920	-0.34924189357839	3.57846862278869
C	-13.41838746808343	-0.74736368412721	2.32431698397892
C	-13.59098000537801	-2.27191172109458	2.33024639924528
C	-13.58182156679476	-2.95168254063723	3.58412813679942
C	-13.19300348981725	-4.32310348463856	3.60560401603014
C	-12.81205385312045	-4.94902227261853	2.37801240088607
C	-11.77213776508271	-5.93665255846935	2.40326889690211
C	-11.15508346693438	-6.24390510164101	3.65876858346449
C	-9.74929257456854	-6.46462123793340	3.68844810018182
C	-9.02056448188476	-6.37282172518034	2.45648200090839
C	-7.75865630982336	-5.68957604055350	2.46554493871753
C	-7.30832484843537	-5.12567323322603	3.70113656038224
C	-6.76497740074605	-3.80993499979355	3.68150360518411
C	-6.72671516211647	-3.06667310458789	4.89949703201503
C	-7.10122028870165	-1.68506097522365	4.86352403395623
C	-7.49406257646073	-1.04767677841843	6.08070743826804

C	-8.57936735494360	-0.12402740375675	6.05220749709816
C	-9.23326212934861	0.12571180309808	4.80650137426142
C	-10.65057010566510	0.30914943642863	4.79708910029461
C	-11.37436771789966	0.23804711025699	6.03348384311208
C	-12.66641530822787	-0.31683343207391	6.01695306098003
C	-13.15335493214942	-0.83959022408407	4.79826531945138
C	-13.65079876849481	-2.22057203065329	4.80464927775942
C	-13.63696811414940	-2.91313991619058	6.04726787770965
C	-13.24890566089688	-4.29432324657966	6.06513962633969
C	-12.86176520581582	-4.93128557479533	4.85038661863236
C	-11.82243195578143	-5.91387464308075	4.87943755677680
C	-11.20234986106633	-6.22196477998440	6.12776406417598
C	-9.78895235969594	-6.43306866923794	6.15622484270803
C	-9.05917538074305	-6.33406967164859	4.93219737411415
C	-7.80773511741669	-5.63799613229856	4.94001853662610
C	-7.34489692894037	-5.07646908935080	6.16909947779094
C	-6.78947272384269	-3.75949937850414	6.14774707914987
C	-6.75812999187289	-3.01062625277791	7.36684210891069
C	-7.10424866681268	-1.62605891271135	7.33160161572856
C	-7.50522318674119	-0.98982598433018	8.54521908922682
C	-8.58819162699666	-0.06675460556618	8.51924546585266
C	-9.25989562958756	0.18835360502173	7.27809690531224
C	-10.66115019401957	0.39544183331908	7.27148692340744
C	-11.38604711722827	0.26075071157068	8.50656796250231

C	-12.67106567398840	-0.29657800475289	8.53351665587937
C	-13.44263894602583	-0.67665597485012	7.28017088411317
C	-13.67526713635081	-2.19489819478496	7.28082067760304
C	-13.68492733578164	-2.88183766494360	8.49692927801772
C	-13.30644318001693	-4.26982127738433	8.52500633805840
C	-12.91483178552441	-4.90245309700858	7.31152607015744
C	-11.87365526642217	-5.88655266488466	7.34463283387382
C	-11.25260805766345	-6.17797993112068	8.59097823622832
C	-9.83551213128432	-6.37094679280501	8.62167845276496
C	-9.10099758889373	-6.27941902261789	7.40127956738125
C	-7.84832697263556	-5.58704628486252	7.40870830083384
C	-7.39310632862217	-5.01877646771931	8.63520455702279
C	-6.83396424012794	-3.70329900889285	8.61391996536410
C	-6.80155207507365	-2.95622440479181	9.83500082018761
C	-7.13789706321701	-1.57789273043769	9.80039018713115
C	-7.50436716621157	-0.93094550521243	11.02516187394820
C	-8.58680871063577	0.01463802512052	10.99897997492908
C	-9.25135410926869	0.24793847045597	9.74926400611435
C	-10.65880988192708	0.40690924637543	9.74585191693300
C	-11.35573517432150	0.32979238547554	10.99209898945991
C	-12.62083374072091	-0.34807060179360	11.00424805179213
C	-13.12828446274855	-0.85206947981982	9.76396188771786
C	-13.68847592614601	-2.16125189318640	9.75926223988251
C	-13.75527930798645	-2.87315939586607	10.98924836300108

C	-13.40207091408846	-4.27523159081369	11.00555767003746
C	-12.97142212960635	-4.87697052723721	9.77329533147394
C	-11.92356634829640	-5.83496259494885	9.80711543989379
C	-11.30889772141269	-6.13256807349450	11.06638066475676
C	-9.88300150310794	-6.31079631672734	11.09933457624313
C	-9.15506329687768	-6.19928476493513	9.86882314283837
C	-7.91410458713766	-5.51009744142655	9.87562412089902
C	-7.45073526937918	-4.95619596150530	11.11412991918430
C	-6.86868804296083	-3.64179099259953	11.09280601532410
C	-6.78178343727710	-2.90338913911561	12.30373665611488
C	-7.10193559651787	-1.49509477328538	12.26815606547958
C	-7.45421413107535	-0.76645130045782	13.45236497675870
C	-8.48590891088607	0.13738682931183	13.42730879726662
C	-9.22567475305470	0.36872767441937	12.21914638766041
C	-10.65837653147822	0.52635902486165	12.21861917199149
C	-11.43208385617422	0.43509662283733	13.42472264804200
C	-12.62545441386564	-0.24165519330070	13.43350964592441
C	-13.12405845053461	-0.85388373177517	12.23328663620861
C	-13.72706378111543	-2.16102004267352	12.22720463288181
C	-13.87525293638855	-2.93287349748499	13.42930777104797
C	-13.58116661632037	-4.27057775049761	13.43596522944705
C	-13.10188318160166	-4.90637647986558	12.23696589328947
C	-12.00687592042838	-5.85383828695276	12.27256304261880
C	-11.34229945112616	-6.19554408829814	13.49458672751475

C	-9.97694094164378	-6.35146654437801	13.52673660129118
C	-9.19660100185177	-6.18596104410867	12.33766690723343
C	-7.93324246900230	-5.47996802207193	12.34494712842035
C	-7.39022445849878	-4.91081108921880	13.54365546362543
C	-6.83064999798120	-3.65716896535927	13.52298359815457
H	-6.32894526618279	-3.62834580464324	-0.94279235310341
H	-6.99353300935544	-1.28616482272475	-1.00660628209294
H	-8.68476491212824	0.10753969041847	-1.06207027533128
H	-11.09591548814806	0.42132580038022	-1.09167283984269
H	-13.23685858343754	-0.38837834878711	-1.10892260739485
H	-14.10826210180962	-2.68605258152458	-1.01214625061894
H	-13.19561201799776	-4.71056621913014	-1.01701395574069
H	-11.43026565704298	-6.38348549566447	-0.97800610830960
H	-9.30698292911403	-6.85504345519110	-0.91794837923987
H	-7.16837578293294	-5.68829915018359	-0.90710587870076
H	-7.00310061380488	-1.03213133370751	14.41007306955722
H	-8.83074292050568	0.57386887472052	14.36639682643176
H	-11.00585021016603	0.77025954983880	14.37193688780068
H	-13.12131221797724	-0.43185632366184	14.38728266143004
H	-14.09104904773618	-2.42939908485304	14.37390569643081
H	-13.57623027438751	-4.81375188592339	14.38231214578336
H	-11.89417915153236	-6.18309918864783	14.43564259798786
H	-9.48030414015001	-6.45547524913432	14.49311515784038
H	-7.55815108484604	-5.40084360074056	14.50429604110466

H	-6.56530276612163	-3.18084993361173	14.46850766164357
C	-14.72897495631793	0.17502335181988	7.17228274965616
O	-14.79449262701146	1.30854963795897	7.59466278120228
O	-15.68949960499191	-0.41434002830447	6.46605985008715
H	-16.33636932901317	0.26739728412088	6.18814601025079
C	-14.82263988817620	-0.09219797474058	2.43785234609946
O	-15.86033703703743	-0.69855495720547	2.39413808009512
O	-14.74268906034341	1.22543857450370	2.68423909685930
H	-15.59950389935483	1.49442287801574	3.07369506734596
H	-14.16756153518820	3.21862305073894	4.31045252965816
C	-14.91452645764482	3.84663210670411	4.81442962680464
O	-17.54875386849147	1.67780009169048	9.11596257996812
C	-15.96449805326666	2.94437750472402	5.39476533109300
N	-16.95352021821234	2.56253860877612	8.59968163550190
O	-17.42164694099287	2.67489389255282	7.14312197945407
O	-16.32560988596091	1.88378805090474	4.94806981187462
O	-16.17168102789403	3.36575690402143	8.96108646918568
O	-16.52177495562075	3.53696940027163	6.49091959574117
H	-14.44955443939017	4.46475689305072	5.59278104120339
H	-15.37998320904445	4.50762026611354	4.06505681914522

ffCNTO₃

C	-6.54613350376134	-3.15519943191751	0.02956489759877
C	-6.87346456497383	-1.82700326752813	0.02536433666301
C	-7.34477677297071	-1.18713445191930	1.22784581983443
C	-8.40492748061686	-0.24106626354440	1.22502878882043
C	-9.07924365604581	0.16212772204608	0.01150493965599
C	-10.42154838473443	0.38713140704316	0.00841037409231
C	-11.20656459328464	0.24231675823742	1.22215682900739
C	-12.51626045733897	-0.20446088016884	1.20613595028730
C	-13.14402922484866	-0.72203553427579	-0.00703914517067
C	-13.64751086204031	-1.98054551732256	0.01954505027961
C	-13.53871675229644	-2.78241134752935	1.24652094875672
C	-13.17817679352078	-4.18007936340338	1.21903215496683
C	-12.83175695771965	-4.85232243481250	0.00703102038519
C	-11.87050995753785	-5.83706162029022	0.00025045349520
C	-11.19227181885834	-6.20296140696886	1.20519329455086
C	-9.77973881970873	-6.49508622761618	1.21787313528146
C	-8.98455532153814	-6.45820173063219	0.02180709947908
C	-7.75900683745992	-5.84537545781599	0.02983027520906
C	-7.26506874253686	-5.23882272618135	1.23589244173864
C	-6.68073356271788	-3.92938237702474	1.23678079781918
C	-6.65596112429770	-3.20611387756107	2.46654716851419
C	-6.98642839230307	-1.81535143462914	2.46515104681446
C	-7.35328626490729	-1.19974886915738	3.70090516371484
C	-8.41043434422383	-0.24530574484959	3.70242037186245

C	-9.07464838537978	0.05103603884546	2.46168226870104
C	-10.46611037613716	0.32170278306029	2.46836607920098
C	-11.17267230749815	0.26378109728359	3.71154208248746
C	-12.49359921155137	-0.23453998678144	3.73475976834260
C	-13.25851046004140	-0.59179657123757	2.47237711125420
C	-13.48738570788627	-2.10640275388093	2.45837863552749
C	-13.49468926082504	-2.81234230927162	3.69660248341378
C	-13.15840227564442	-4.19816714374657	3.68532061793755
C	-12.81441879829763	-4.81314332449950	2.44253482436822
C	-11.81388082606441	-5.84039888745566	2.43602158090398
C	-11.19761554552031	-6.19756517020452	3.67812164753996
C	-9.80061915145038	-6.46878845744652	3.68926738226593
C	-9.08084996582021	-6.37595760836691	2.45241002946591
C	-7.79644439444289	-5.73634887086905	2.46310070542351
C	-7.31491031468833	-5.21583018861577	3.70598535325178
C	-6.72669870780329	-3.91979498266735	3.70862073948856
C	-6.64965263227488	-3.20419762582492	4.94172262741075
C	-6.97470542536195	-1.81065932255609	4.93820922927761
C	-7.33293834742079	-1.18425144164653	6.17131897491354
C	-8.38491410078349	-0.22179288884190	6.17191192795916
C	-9.04000253656406	0.08134529339281	4.93921279203807
C	-10.44790925060680	0.32395992873683	4.94622618381824
C	-11.16221847243904	0.24923401689588	6.18725179023075
C	-12.47058914297416	-0.26677177485014	6.17427806337741

C	-12.99213789468454	-0.73950523388707	4.94801718393450
C	-13.52543730727692	-2.10529703161700	4.93148366944192
C	-13.53097351130009	-2.82522860195014	6.15841542621719
C	-13.19413169167530	-4.22057445163685	6.14435193682504
C	-12.84162932607189	-4.84641935275437	4.91346020946521
C	-11.84101447667518	-5.86762200980460	4.91183923094903
C	-11.22229068664665	-6.22615256481503	6.14755473635941
C	-9.81708105475863	-6.48779444264784	6.15795343960821
C	-9.09492675720936	-6.38918856041126	4.92910646660273
C	-7.82132812698322	-5.73637345747439	4.93913043414833
C	-7.32733195525536	-5.21762952901931	6.17524285107741
C	-6.72698585321694	-3.92026608394090	6.17570579500860
C	-6.65772118935426	-3.19892992858880	7.40963631899647
C	-6.95717128307009	-1.80343146438968	7.40641111553732
C	-7.31956666921946	-1.17706453558811	8.63830093985985
C	-8.36843753963719	-0.21723763809479	8.64221947197510
C	-9.03873295648856	0.09093773842941	7.41146547087127
C	-10.43241597095665	0.34142481171198	7.42195538442292
C	-11.14735633517656	0.21492968450418	8.66508674605882
C	-12.44286019596629	-0.30995400083658	8.68947622284578
C	-13.23408214624449	-0.62711280745342	7.43780446346406
C	-13.52868646537072	-2.13308344391360	7.40716610551713
C	-13.55693056620336	-2.84689824702188	8.60707651941878
C	-13.23132414263118	-4.24695174669647	8.60329505502269

C	-12.87443684715291	-4.86887018061193	7.37318690563691
C	-11.87018035840254	-5.89137852670077	7.37664449029119
C	-11.24909314561618	-6.23037519441605	8.61120737484191
C	-9.84062268199180	-6.47298574035459	8.62493764315342
C	-9.11348581040941	-6.38346453144037	7.39910284883335
C	-7.83828691528497	-5.73450786403708	7.40883169521889
C	-7.35208100241954	-5.20852467860879	8.64316531692805
C	-6.74905437246351	-3.91391386932756	8.64380164385391
C	-6.67595701122170	-3.19426530160531	9.88008118037662
C	-6.96150394319644	-1.80420188861796	9.87754242200673
C	-7.29196398409115	-1.17008726238919	11.11850546340380
C	-8.33865793099518	-0.18475279291169	11.12297815726148
C	-9.00548914445458	0.10009726030513	9.88611866000128
C	-10.40529524270034	0.31148717247867	9.90010801416434
C	-11.09434532911355	0.23183273345237	11.14944336688705
C	-12.38176602949496	-0.40313451244397	11.15882763958741
C	-12.91403811625205	-0.86716021176184	9.91569862926659
C	-13.51732183424223	-2.15352633356777	9.88681564147531
C	-13.60500595202907	-2.88744497617423	11.10099108484549
C	-13.30670313709076	-4.30240590486085	11.08441621925067
C	-12.91012482579178	-4.89351602498801	9.83623146596322
C	-11.89710058016158	-5.88842499240747	9.84091914799243
C	-11.28252335689949	-6.23398165963519	11.08746261066589
C	-9.86370694521061	-6.46364318461209	11.10353030100647

C	-9.14317528304111	-6.35258776980472	9.86925494442644
C	-7.87888365384888	-5.70754241684683	9.87847764075861
C	-7.38521650126948	-5.19631909959482	11.12304414014614
C	-6.75658704703834	-3.90338320460943	11.12340321118046
C	-6.63222214971641	-3.19430265418728	12.34897168315141
C	-6.90196318679864	-1.77649874265056	12.34597433522625
C	-7.21514328987463	-1.05982122364095	13.54947385677331
C	-8.21286916222710	-0.11936254002211	13.55366736687490
C	-8.95414450487780	0.16510589271052	12.35691840391424
C	-10.37886026579527	0.37209438937673	12.37330509868564
C	-11.14568606971928	0.28448216057772	13.58612157558501
C	-12.36085058532467	-0.34966792561564	13.59172207041205
C	-12.89083801734973	-0.91851710859555	12.38190574297048
C	-13.53627724134725	-2.20170258077467	12.35313981436641
C	-13.70801899171141	-2.99299280004527	13.54173205476305
C	-13.46323969630200	-4.33887924604119	13.51686566128667
C	-13.01771451879172	-4.96827025686773	12.29947417253419
C	-11.95879957402598	-5.95385619849987	12.30615435584677
C	-11.29707414641554	-6.34575182022069	13.51566672773961
C	-9.93852762831103	-6.54994434145281	13.53152361008536
C	-9.16285708859739	-6.38730433883632	12.33803394392287
C	-7.87676322714427	-5.72682323442904	12.34789744996088
C	-7.30133980216366	-5.20393122074417	13.55351907843141
C	-6.69711480878643	-3.97174776588571	13.55341802510950

H	-6.32556442118957	-3.65494696531852	-0.91543349597977
H	-6.90266564632423	-1.28831785394122	-0.92340155015914
H	-8.52969069989665	0.18019832733143	-0.93141970081742
H	-10.93311771481472	0.58404278344760	-0.93543471295593
H	-13.11840794099941	-0.15582885101168	-0.94200346142140
H	-14.06737539163787	-2.42955432160969	-0.88265526082196
H	-13.22784430327358	-4.49228080782960	-0.94356147618755
H	-11.52501419849196	-6.22957690064361	-0.95747199281353
H	-9.41475549159297	-6.77739351672741	-0.92910523710532
H	-7.23590499302125	-5.68648242619540	-0.91498827312586
H	-6.76320131581273	-1.36092949428687	14.49615137873410
H	-8.53156818995682	0.31162014791571	14.50440681825418
H	-10.70065430752152	0.58875567725517	14.53497945588620
H	-12.85849245048200	-0.53820481733126	14.54483297628562
H	-13.90359356261489	-2.50176518954953	14.49694829682143
H	-13.47633352404420	-4.90388131310102	14.45032300176387
H	-11.84105455436425	-6.33564621717532	14.46129573532851
H	-9.43736078527580	-6.69436032950134	14.49032467547367
H	-7.47624133239750	-5.70952547897758	14.50475355184282
H	-6.40300060177301	-3.52632679491508	14.50543621691968
C	-14.51370717763421	0.27917039667111	7.39420544028302
O	-14.60827325936510	1.28797194330324	8.04310341753818
O	-15.38015530467593	-0.16525218925972	6.49495063779957
H	-15.94187872668620	0.57958251336657	6.15111693577442

C	-14.63638782659100	0.13521199640901	2.57662366108769
O	-15.64968820020311	-0.44693476137899	2.87215571204937
O	-14.51148667659465	1.43553242874009	2.37065172259949
H	-15.37495792778583	1.88114265136301	2.61434922955168
O	-17.14309574340613	2.07195900546453	4.28137987416041
O	-16.92511055766341	2.41511802920070	3.05411988442138
O	-16.08850134695072	1.87887196648993	5.00417234586362

ffCNTNO

C	-6.53766165660120	-3.14058476206351	0.02643361076794
C	-6.87631469779821	-1.80817097038972	0.01649409251551
C	-7.34879118508935	-1.17091683967525	1.20866955291404
C	-8.43944125634624	-0.22696892150322	1.19730732822912
C	-9.11569345547740	0.13407835176951	-0.01250488315467
C	-10.47061632770470	0.33730609676238	-0.02150718750816
C	-11.24801486406382	0.20676545414784	1.18380451046506
C	-12.57608221928307	-0.26027012717389	1.16435604322391
C	-13.17583852315918	-0.80273648442765	-0.03958554585736
C	-13.68443604406935	-2.06495586782994	-0.00185513925577
C	-13.58403249478061	-2.85391834204130	1.22863483139764
C	-13.20230909371857	-4.25163006200979	1.20441302305416
C	-12.84479831669201	-4.92315606812509	0.00090243693328
C	-11.86198418401441	-5.89229286434886	-0.00171762194823
C	-11.17533384372346	-6.23674619037674	1.19889505947994

C	-9.74978062447778	-6.51343702738853	1.21192910132258
C	-8.95890163553257	-6.46003782614395	0.02192248539976
C	-7.73181735135319	-5.83827167144235	0.03018128976169
C	-7.24156969934690	-5.23326618762495	1.23050368726795
C	-6.65715956399139	-3.90761397825890	1.22877096519854
C	-6.65730685251475	-3.18190802973288	2.45212942097224
C	-7.00964501437436	-1.79384727726514	2.44235036307234
C	-7.39798733920193	-1.17880146933404	3.68166295820310
C	-8.46672029502057	-0.24547256345946	3.67369606311254
C	-9.12286527109727	0.04193061343546	2.42430361861883
C	-10.52459815130802	0.28289228480123	2.42152223877882
C	-11.24105839143594	0.21414096002260	3.67464995511176
C	-12.54895719416829	-0.29114376075600	3.69849077124354
C	-13.31441955811034	-0.64966198329218	2.43451301403845
C	-13.54701225942942	-2.16908778897637	2.43487889961216
C	-13.54244852164016	-2.86823859903581	3.68122303236692
C	-13.17444632463611	-4.25137829996035	3.67272907316338
C	-12.81599570204786	-4.86396546487123	2.43072096533947
C	-11.79676264505537	-5.87308535239547	2.42705911565700
C	-11.17435190288947	-6.21785589039135	3.67311046683840
C	-9.77378627303804	-6.47315300425680	3.68484886477839
C	-9.05626055579554	-6.37271219513898	2.44459984607749
C	-7.77830229581346	-5.71944998293063	2.45418535968175
C	-7.30338443607319	-5.18950457725179	3.70208422625996

C	-6.72951685828958	-3.88936295887913	3.70063680214671
C	-6.66317213545401	-3.16750428603240	4.92953395945187
C	-7.00368860675403	-1.77009592238541	4.91939753515190
C	-7.38459347339068	-1.15118125557583	6.14302825976069
C	-8.45710191494685	-0.20466044833757	6.13537261956349
C	-9.10759978943136	0.08319073834904	4.90599047963091
C	-10.52445763787204	0.31288548218325	4.90734618365269
C	-11.23978962438544	0.23904638001309	6.14192250370581
C	-12.55030761026263	-0.29311548504905	6.13145318096346
C	-13.05969353525466	-0.79026773130401	4.91905848200188
C	-13.59365830515922	-2.16350901713752	4.91182429417454
C	-13.56115676115028	-2.87911096951801	6.13753677961604
C	-13.20384278004117	-4.26977066264339	6.12886752119298
C	-12.84288454048233	-4.88987722820716	4.89923139764624
C	-11.82705475823433	-5.90547086546368	4.90134386416532
C	-11.20145243013302	-6.24461094603894	6.13555714430314
C	-9.79137978740576	-6.48795451859624	6.14781923027034
C	-9.07053183270596	-6.38453852042868	4.92236370086030
C	-7.79398586920826	-5.72125411705448	4.93274935827332
C	-7.31837779047456	-5.18616955346384	6.16408414120065
C	-6.73747339516006	-3.87691987234369	6.16088376782311
C	-6.68779247103469	-3.14871013575072	7.39589369114776
C	-7.01380760030503	-1.76235931110803	7.38515841681959
C	-7.38687047435749	-1.13336769835429	8.61448955632137

C	-8.44564169957715	-0.18197153142663	8.61135864082626
C	-9.12005342466377	0.10314341666433	7.37602865723277
C	-10.51457868263321	0.33149010996667	7.38065464522883
C	-11.23010090486716	0.21580668733710	8.62992385900180
C	-12.51848721049687	-0.32260021388291	8.65809106952082
C	-13.29751916220938	-0.67247327075812	7.40636874227964
C	-13.55216852308219	-2.18705615443882	7.38638411150835
C	-13.56879796163791	-2.89215076425396	8.58573186523698
C	-13.24295089544593	-4.29531756113672	8.58877133260936
C	-12.87242896672924	-4.90999409737687	7.36093687593575
C	-11.85447100298449	-5.91881795241101	7.36719424815297
C	-11.23025031048887	-6.24645383369967	8.60203903278355
C	-9.81510621166137	-6.47758063610678	8.61802603971200
C	-9.09092226876822	-6.36899135384221	7.39305765706829
C	-7.82680073258401	-5.70173643855977	7.40199533893641
C	-7.34960817882289	-5.16453953769656	8.63527157012832
C	-6.75938161980766	-3.86006875941408	8.63281269829223
C	-6.70880060834278	-3.13421207304252	9.86218054045074
C	-7.01705907144887	-1.74640832175186	9.85358094192085
C	-7.36042346302541	-1.11294096143397	11.09194581250615
C	-8.41879221966843	-0.14135101499731	11.09007517971498
C	-9.08706826975724	0.13309269306749	9.85024033699427
C	-10.49041364136569	0.33436940079718	9.86304388749713
C	-11.17813700565395	0.25136552095134	11.11323812615130

C	-12.45358474318867	-0.40678603254295	11.12710427441130
C	-12.97817505912590	-0.88793066375934	9.88678192380557
C	-13.54538919439876	-2.19088322806359	9.86205151468097
C	-13.62241644524483	-2.92037713247122	11.07948459385394
C	-13.30766614646114	-4.33176424887495	11.06876675394384
C	-12.90901007265635	-4.92701823830415	9.82092656487698
C	-11.88366135549313	-5.91178714914641	9.82965771236811
C	-11.26396019709229	-6.24171979975201	11.07890731431919
C	-9.84249224673474	-6.45147116940847	11.09598283411471
C	-9.12300578050898	-6.33587538298473	9.85926222449303
C	-7.86702147132452	-5.66966083660978	9.86852490068033
C	-7.38659448195474	-5.14302976447912	11.11339289774609
C	-6.78419271832297	-3.83858798962569	11.10991960402596
C	-6.67223785213236	-3.12196571063407	12.33323573885766
C	-6.95882098323155	-1.70492775762701	12.32300954028449
C	-7.28551707918861	-0.98771617759564	13.51992431834400
C	-8.29238058986960	-0.05474019683023	13.51963084011797
C	-9.03756758610125	0.21235339593971	12.32274555220460
C	-10.46478834000473	0.40966183223098	12.33723100834493
C	-11.23017290676851	0.31192034145925	13.54909022178937
C	-12.43513966550885	-0.34303374275885	13.55934786472868
C	-12.95239280656760	-0.92935663805531	12.35278023688317
C	-13.57392885850583	-2.22482225353162	12.32835217448746
C	-13.73040717380563	-3.01450863880233	13.51927215990823

C	-13.46442114430342	-4.35709012621901	13.49886851255175
C	-13.01011313805122	-4.98737880930677	12.28547426247983
C	-11.94541885080654	-5.97039945760797	12.29705824784613
C	-11.27830131661075	-6.34665200838705	13.50546429055034
C	-9.91584623732250	-6.53653332282789	13.52243513960525
C	-9.14326525324245	-6.36237144253011	12.33063139326262
C	-7.86345143699760	-5.68275729786414	12.33976727353092
C	-7.30442207941903	-5.14040826237818	13.54127018486332
C	-6.72164277138616	-3.89559047380100	13.53840440381209
H	-6.33401210066662	-3.64154777962883	-0.92176381047846
H	-6.92689467394420	-1.28326868561728	-0.93899393381956
H	-8.57580653279908	0.12041237201914	-0.96090346189033
H	-10.98136745942119	0.48271767195116	-0.97473454002237
H	-13.10458736468394	-0.27146723380635	-0.99260636612353
H	-14.07028344549281	-2.52963642708964	-0.91122274601266
H	-13.24108361340589	-4.57439111099387	-0.95407361699662
H	-11.50683074040527	-6.27569027408716	-0.95966969140511
H	-9.38965705412531	-6.76443645875656	-0.93375942220639
H	-7.22148421084448	-5.66229609803580	-0.91854771367585
H	-6.83487780719398	-1.28096734753389	14.46992648749451
H	-8.61791055893089	0.37445824180643	14.46881090064320
H	-10.78903406189581	0.62429101337228	14.49730995428444
H	-12.92622909798025	-0.53989285544942	14.51413819357595
H	-13.93093397047606	-2.52358253269701	14.47368161900353

H	-13.46527737803776	-4.91706358016027	14.43555728267175
H	-11.82023558941478	-6.33633499974156	14.45257842578741
H	-9.41314411422074	-6.66728486146876	14.48237955360279
H	-7.47572498522033	-5.64121694814630	14.49591891782231
H	-6.44386140616813	-3.43966162986608	14.49034350648954
C	-14.60686688895348	0.16405795304520	7.36481389780121
O	-14.70787477751307	1.28254639922211	7.79677985144199
O	-15.58165211674686	-0.48697866625793	6.72022265774705
H	-16.31726410603581	0.13481024262201	6.56229533814181
C	-14.66492809203560	0.10874959124935	2.52848151960467
O	-15.71238559653641	-0.38211501025971	2.86073942679357
O	-14.51071149352887	1.41397351641756	2.25493755464873
H	-15.36736493658367	1.84471040953506	2.41874328131535
N	-17.38614128567124	1.40204882914917	5.18207713117208
O	-16.94939052024363	1.97186686186279	4.28881335214704

ffCNTNH₃

C	-6.55443580650124	-3.06027953538897	0.01507908522940
C	-6.93178233043938	-1.74656857968475	0.00374443002282
C	-7.44115496711780	-1.12280127521403	1.20124304389594
C	-8.53896601808297	-0.22723074876147	1.18803536504488
C	-9.22664149104496	0.13878162256407	-0.03163834388300
C	-10.57775539222935	0.29552167118299	-0.04317083740626
C	-11.36331331344396	0.11585135637753	1.16741796560192

C	-12.64930903900081	-0.38746597776402	1.14741027165682
C	-13.25524961506393	-0.93363569849431	-0.06475717208370
C	-13.73595912901859	-2.20040306164321	-0.03056369207227
C	-13.61261193661159	-2.98917257942873	1.20501047080014
C	-13.19097802675234	-4.36929864126240	1.18824977918842
C	-12.80634269436212	-5.03049156502630	-0.01968512844259
C	-11.79616301957677	-5.96384383596851	-0.02003411986145
C	-11.10087763723183	-6.28579043032434	1.18895177810142
C	-9.67784368463820	-6.51419879113848	1.20576462834387
C	-8.88187029103380	-6.44683997694725	0.01051335745172
C	-7.68049448269454	-5.78904246770998	0.01948563161425
C	-7.21123383802367	-5.16159202378975	1.22589925978878
C	-6.67119736635004	-3.83596400924605	1.22512108852554
C	-6.67870118275377	-3.10701440655159	2.45289418022711
C	-7.06107450418551	-1.73060000833248	2.44507895776345
C	-7.46150124774099	-1.12720597602934	3.67501855745424
C	-8.56095845585247	-0.21907681458889	3.66735578723008
C	-9.23129981281782	0.03881172168696	2.42049316797937
C	-10.63104693711586	0.24269644415725	2.41798498317353
C	-11.33951103969921	0.15695966622422	3.65705072468601
C	-12.63505242921352	-0.40150136239748	3.67726383737120
C	-13.38732636742168	-0.78328399416580	2.41298478127504
C	-13.59509268270133	-2.30043464496786	2.41195498867932
C	-13.57157073147432	-2.99760659968508	3.65571372165272

C	-13.16901554858986	-4.36455089503855	3.65451747245249
C	-12.79600911114214	-4.97315644222110	2.41629936305779
C	-11.74280741278162	-5.94779247160870	2.41717629128748
C	-11.11174564578464	-6.26902453890686	3.66132898463825
C	-9.70455665876696	-6.48242380325076	3.67658607069214
C	-8.98636924799591	-6.36379674661381	2.44133084429580
C	-7.72646917537283	-5.67736867045822	2.45406566436708
C	-7.26692681021337	-5.13727319981091	3.69590401309269
C	-6.72646821816853	-3.81921053388498	3.69687589603634
C	-6.68520947173710	-3.09731189311105	4.92699558755348
C	-7.06787296826415	-1.71887881837913	4.91692199241544
C	-7.46225211776337	-1.10493499573420	6.14624290171676
C	-8.55231382967974	-0.18986189430589	6.13872181064913
C	-9.21330003205751	0.07896715074089	4.89826664098211
C	-10.62979520379108	0.25450800037525	4.89772164873952
C	-11.35247690199509	0.16089644843965	6.13625096322343
C	-12.64461445041559	-0.38139543368281	6.11957006733360
C	-13.13079223227544	-0.89920792768734	4.89251933899169
C	-13.62481906193452	-2.27898798209009	4.88792593318801
C	-13.58916065197005	-2.98898528904202	6.12261170430940
C	-13.19222790865402	-4.36985946632339	6.11595289523293
C	-12.81499217450167	-4.98656008637405	4.88890210108974
C	-11.77040530989350	-5.96204767629477	4.89327942475567
C	-11.13851958767691	-6.29123794099927	6.13094385844193

C	-9.72471437342793	-6.49800550465750	6.14566350780639
C	-9.00476694618785	-6.37244861941040	4.91762211578168
C	-7.75706036327916	-5.67257317882833	4.92934628612569
C	-7.28695874309812	-5.13148873384676	6.16594939397634
C	-6.73881512158804	-3.81262629528253	6.16453422008779
C	-6.70383894441187	-3.08458945691550	7.39542472607445
C	-7.06002771662856	-1.70080166428266	7.38558038422281
C	-7.45681110815424	-1.08658577259277	8.60841280718727
C	-8.54664189549412	-0.16650143588826	8.60222712167522
C	-9.22741563782560	0.10315030716250	7.37120021653988
C	-10.63162896509261	0.31008410012439	7.37498070321833
C	-11.34776081372652	0.16299555416643	8.60822056298428
C	-12.64175155178063	-0.39588687771891	8.63894089336176
C	-13.41613763137113	-0.76212609781898	7.37169511439894
C	-13.61503068302884	-2.29281235768843	7.36768946522512
C	-13.60599122850793	-2.99894342792586	8.57480231943308
C	-13.22240460544724	-4.38430780170359	8.57669278925194
C	-12.84244566427562	-4.99615307252452	7.34886762193642
C	-11.80115950981944	-5.98026886937183	7.35798449480214
C	-11.17155292952322	-6.29455502249831	8.59480859206228
C	-9.75337144445078	-6.48256870574890	8.61225619640252
C	-9.02825556755925	-6.36607147358941	7.38843668964228
C	-7.77834070605149	-5.66738810342308	7.40017984354239
C	-7.31796646940623	-5.11882000925861	8.63291480284517

C	-6.76902562198982	-3.79762201024644	8.63059471753681
C	-6.73664784776731	-3.06980273309197	9.86271854024732
C	-7.08261587400144	-1.69358007010591	9.85155444306048
C	-7.44547725491240	-1.06697990072773	11.08805584648159
C	-8.52947074001727	-0.12279177503286	11.08163981213887
C	-9.20289340950591	0.12734167498052	9.83854980856869
C	-10.61111273793253	0.28628272878976	9.84460386115638
C	-11.29726127961176	0.18926890858676	11.09674467512180
C	-12.55662556474560	-0.49890648190748	11.10826729393343
C	-13.07184296760042	-0.98526940172558	9.86310141781477
C	-13.60932618545311	-2.30423092914005	9.84599193825126
C	-13.66099671601673	-3.03563813474908	11.06431348877993
C	-13.30375893123310	-4.43576356735459	11.05626396648934
C	-12.88213707523635	-5.01580735318552	9.81154723012834
C	-11.83405863448478	-5.97434438691559	9.82103528915783
C	-11.21069192105826	-6.29297049346988	11.07121202275645
C	-9.78397333442983	-6.46709659211894	11.09127512740996
C	-9.06498428072192	-6.33033495791766	9.85769150472403
C	-7.82876122684792	-5.63289963556034	9.86824862740357
C	-7.36215138516201	-5.09532355981942	11.11330009726735
C	-6.79209465900741	-3.77541390032620	11.11032658540759
C	-6.70303887279333	-3.05571924244141	12.33167562145129
C	-7.03274636453674	-1.64745902273466	12.31973211047520
C	-7.37947072045159	-0.93764190410641	13.51561356292531

C	-8.41180082515360	-0.03278563810717	13.50917008309076
C	-9.15752915521953	0.21734542497294	12.30979109645889
C	-10.59268939723006	0.37354108864856	12.32040661645914
C	-11.35633844894909	0.26029601957753	13.52955896486515
C	-12.54380702200067	-0.42884408693594	13.53719385401740
C	-13.04591319649142	-1.02745519521453	12.33344444196721
C	-13.63444274088279	-2.34342508138436	12.31331806941162
C	-13.76709905022165	-3.13413215581021	13.50250275903177
C	-13.46643621603999	-4.47210621256274	13.48651442284802
C	-12.99704095254052	-5.08832843306900	12.27568735769716
C	-11.90084870940115	-6.03619315051640	12.28687621130022
C	-11.22771753602415	-6.39969192674160	13.49753318877547
C	-9.86135730368163	-6.55094099126453	13.51743948309031
C	-9.08983287691144	-6.36096252569068	12.32675231082930
C	-7.83219103025127	-5.64330209637549	12.33818102559104
C	-7.28818379546017	-5.08810805003553	13.54243800942532
C	-6.74082283648150	-3.82834111946513	13.53856039841066
H	-6.30321905225748	-3.55421827935901	-0.92546108242595
H	-6.97092834725238	-1.21034798700861	-0.94620563821380
H	-8.67244004478141	0.18312330590238	-0.97119919431127
H	-11.09261863295344	0.46549696937525	-0.99069124609534
H	-13.23383949029743	-0.37669308265785	-1.00576787164124
H	-14.14042897326597	-2.66730808772030	-0.93086299986283
H	-13.22026357374987	-4.69811773221340	-0.97288198608311

H	-11.43026680730941	-6.34563296651612	-0.97449678828209
H	-9.29751556622577	-6.78459573376716	-0.94051148632896
H	-7.16123731412099	-5.61293359292506	-0.92443792151299
H	-6.92518969061233	-1.21853901610045	14.46745892953503
H	-8.75211561214987	0.38780708804085	14.45713757523539
H	-10.92459597093576	0.58181762676031	14.47900382812789
H	-13.02719690636096	-0.64121002710645	14.49280077680585
H	-13.97123909544193	-2.64663991845508	14.45808148797635
H	-13.44656151259448	-5.02687658064666	14.42592370973697
H	-11.77288407919192	-6.40496908411764	14.44258565272752
H	-9.35788730969097	-6.67012050026273	14.47857684294965
H	-7.44844794901760	-5.59333533978005	14.49648402482385
H	-6.47649745645108	-3.36438956501194	14.49053451115833
C	-14.77242652951519	-0.01017499970675	7.36032630549281
O	-15.04277690273022	0.92361308575811	6.64229246987569
O	-15.63465684642704	-0.50321937478727	8.25913871572171
H	-16.44378881621292	0.03435087384539	8.21412628892585
C	-14.74945711297401	-0.03233051470076	2.55790832033635
O	-15.77131370151975	-0.60290923174461	2.87573970281735
O	-14.60479718296578	1.26828589397696	2.42813951002135
H	-15.37769086844226	1.71996958808214	2.94545115472822
N	-16.46749233794895	2.02743209133447	4.10083494996457
H	-17.02111014817453	2.87923726697190	4.19319512746227
H	-15.99589344483656	1.84697002570250	4.99403546672732

H -17.09973420336630 1.23914281723752 3.94571209550737

ffCNTHg

C -6.56131451408020 -3.09492696576106 0.01873533364165
C -6.92030868469333 -1.77411711350895 0.00967318412093
C -7.41180244619478 -1.14294752096732 1.20798692600673
C -8.49856924055303 -0.22550627673845 1.19863849638233
C -9.18203659515560 0.14616156681748 -0.01818376740000
C -10.53286041725417 0.31584149831520 -0.02732787438831
C -11.31794988777542 0.14554483516371 1.18286904018765
C -12.61420914399443 -0.34199837216162 1.15959947619918
C -13.21375675743814 -0.88953532518855 -0.04797745838647
C -13.73618206088094 -2.14320091601826 -0.00887100743207
C -13.62809817639131 -2.92602316284296 1.22748014995146
C -13.21359049528004 -4.31241314406066 1.21008486877833
C -12.84100582577453 -4.97659153656139 0.00231623600039
C -11.84121334463803 -5.92348877942508 -0.00192410968101
C -11.14874057449865 -6.25842806122654 1.20237820045841
C -9.72579048048725 -6.50750820531717 1.21506830573901
C -8.93394976668022 -6.44902737925070 0.01925714157736
C -7.72217125334691 -5.80729658387604 0.02577361662147
C -7.23994019464882 -5.19008724936538 1.22979772583936
C -6.67977646053015 -3.86780036908552 1.22733802029883
C -6.67739665993508 -3.13968645267082 2.45374389520883

C	-7.03927128107894	-1.75669309022897	2.44675786888636
C	-7.43404624152161	-1.14906169282914	3.67823669323165
C	-8.51983192523253	-0.22772619527667	3.67243809042967
C	-9.18882922174897	0.04298641555277	2.42914433038474
C	-10.58751380771283	0.27206869695411	2.42865557714190
C	-11.30064643887855	0.18462442504685	3.66741361183810
C	-12.61280096178069	-0.33671587957218	3.69225809383482
C	-13.37194158381267	-0.71569324166571	2.42545713733534
C	-13.59221529444325	-2.23748634521120	2.43454351313391
C	-13.56115204517330	-2.93446071495083	3.67971081868995
C	-13.17816827496146	-4.30886386635176	3.67599457338001
C	-12.81822565496953	-4.92036215334536	2.43510158224855
C	-11.78023488457262	-5.91071901668780	2.43191397376103
C	-11.15050278752283	-6.24332142903486	3.67459557139623
C	-9.74629626493366	-6.47489054402023	3.68597348765307
C	-9.03000356835161	-6.36505997647323	2.44823790101441
C	-7.76039818653541	-5.69612190317103	2.45736038777415
C	-7.29185250172839	-5.16023046655178	3.69930968509755
C	-6.73350078422925	-3.85113115591814	3.69797409162694
C	-6.67888611590411	-3.12909359764461	4.92816761630492
C	-7.04286280012611	-1.74400406523377	4.91842761616111
C	-7.42454471194709	-1.12451189810841	6.14730941283757
C	-8.50594465008773	-0.19437435294393	6.14104259249620
C	-9.16724635622375	0.07868579753610	4.90546049904078

C	-10.58424300150818	0.27278675356831	4.90766800299787
C	-11.29945701108180	0.19618768379941	6.14957320746632
C	-12.60536263570251	-0.33761885636208	6.13668638466308
C	-13.10486337233863	-0.84034539143950	4.91338182956675
C	-13.60393415661139	-2.22154810811201	4.91057566472803
C	-13.57357241507727	-2.93571203871650	6.14113055547763
C	-13.20074579525664	-4.32055583710011	6.13389313162145
C	-12.83496637021006	-4.94056555193713	4.90537040885703
C	-11.80291502680728	-5.93156887127115	4.90717105823098
C	-11.17289687925802	-6.26729310260014	6.14340740821672
C	-9.76092543188477	-6.48997625469354	6.15430379466489
C	-9.04263826004143	-6.37443997133465	4.92510396254453
C	-7.78443381339388	-5.68996273496643	4.93346873441884
C	-7.30547389505771	-5.15454835625309	6.16806835743320
C	-6.73910346047462	-3.84164957941291	6.16428566971357
C	-6.69347287521143	-3.11259471745976	7.39501618195159
C	-7.03049969132662	-1.72575406233590	7.38473069921030
C	-7.41830018496119	-1.10542819974413	8.61097627047199
C	-8.49247573097065	-0.17299846544848	8.60741497668197
C	-9.17362976468835	0.10552470517934	7.37587138614830
C	-10.57276464837237	0.32705894597274	7.38224196482298
C	-11.28504752687755	0.18189319796368	8.62556095351886
C	-12.56994742217789	-0.36718639767460	8.65759388490094
C	-13.35846226005005	-0.72216198368498	7.40795376591345

C	-13.58761803467137	-2.24087378044785	7.38710059788540
C	-13.59588542414227	-2.94617454245668	8.59116962985917
C	-13.23386590928435	-4.33851496168443	8.59359422666905
C	-12.86091816050034	-4.95384224398460	7.36627124718493
C	-11.82935725494465	-5.94834253466437	7.37261784785867
C	-11.19915902965750	-6.26652776091247	8.60793310648326
C	-9.78346686793505	-6.47182544935505	8.62167564262853
C	-9.05998008054386	-6.36403851716606	7.39580421125112
C	-7.80212683649996	-5.68147478067983	7.40342358553795
C	-7.33213057429842	-5.13621136012960	8.63545172399028
C	-6.76425642041945	-3.82463667493913	8.63107188568718
C	-6.71722810449280	-3.09678293990983	9.86331896545692
C	-7.04388712614757	-1.71559556717445	9.85334123976934
C	-7.39326515562331	-1.08436770132823	11.09076437710927
C	-8.46535366691566	-0.12662140252195	11.08823627793829
C	-9.13957361716701	0.13185883207417	9.84876789848206
C	-10.54469270154237	0.30584388711914	9.86080785997025
C	-11.23007212712669	0.21551587260633	11.11241130149038
C	-12.49831092128437	-0.45662719844589	11.12714076433801
C	-13.01833746334190	-0.93991245509408	9.88496458176356
C	-13.58391579882665	-2.24522295294211	9.86502591245548
C	-13.64599714303185	-2.97622682432733	11.08391843953604
C	-13.30561429853505	-4.38177405176042	11.07432081350272
C	-12.89316698152114	-4.96861841260004	9.82842595805183

C	-11.85536515034805	-5.93796261366608	9.83626009876228
C	-11.23187075716751	-6.26175376131669	11.08459057230618
C	-9.80731310787051	-6.45265424570924	11.10082664853165
C	-9.09022463651518	-6.32595513050350	9.86531991183303
C	-7.84478328200665	-5.64462756835938	9.87225941799830
C	-7.36716152664333	-5.11315052246681	11.11542564908836
C	-6.77835676831634	-3.80159617583676	11.11029919323575
C	-6.67694624939480	-3.08263547135594	12.33209156904881
C	-6.98525867120843	-1.67168281323005	12.32124497991799
C	-7.31920486925962	-0.95729446422558	13.51968333648630
C	-8.34049897093212	-0.04178542409217	13.51771424678875
C	-9.08928063359746	0.21537967118572	12.31981913330988
C	-10.51935954553309	0.38715416418386	12.33508654818566
C	-11.28244539632559	0.28243559673691	13.54763635162512
C	-12.47875758792058	-0.38812282281783	13.55809209750167
C	-12.99107201402771	-0.98064700689184	12.35306422062542
C	-13.60076448361465	-2.28369309134760	12.33246948878354
C	-13.74291828552966	-3.07381595260603	13.52396570423234
C	-13.46107065599883	-4.41373044289925	13.50630432358018
C	-12.99988939910994	-5.03530224779424	12.29226502152881
C	-11.91557445461157	-5.99554535875312	12.30178173844348
C	-11.24303106630637	-6.36372189422079	13.51166064463573
C	-9.87896364234353	-6.53238245154934	13.52823442892248
C	-9.10856111251358	-6.35266326269067	12.33467028901354

C	-7.84113208469527	-5.65427034344109	12.34194682171456
C	-7.28507768987437	-5.10669824052018	13.54486083855123
C	-6.71949924281604	-3.85563519108307	13.53958172219536
H	-6.32882931361723	-3.59205672068039	-0.92488494219083
H	-6.96192918262321	-1.24046498009972	-0.94155196325041
H	-8.63055047035276	0.18256203830095	-0.95970058977414
H	-11.04641999832573	0.48681930968832	-0.97532909747248
H	-13.15276257669246	-0.35222103303412	-0.99870726262604
H	-14.13421169130320	-2.60821810422222	-0.91256040665585
H	-13.25004503610796	-4.63656323220795	-0.95004228112402
H	-11.48145127022177	-6.30469360630215	-0.95896700375900
H	-9.35819065153892	-6.77470133397758	-0.93214447913334
H	-7.20690076945668	-5.63334816504823	-0.92068628609614
H	-6.86150060712374	-1.24157370537875	14.46890868985255
H	-8.67136279702872	0.38526636911438	14.46610077543407
H	-10.84557135325245	0.60252985140232	14.49522643878090
H	-12.96747989443128	-0.58892188184286	14.51336999580451
H	-13.94522665012642	-2.58366943455065	14.47851860369136
H	-13.45252408287120	-4.97234959588820	14.44358684331314
H	-11.78596255431266	-6.36190189956034	14.45800282712654
H	-9.37410678671694	-6.65714610985131	14.48786227423443
H	-7.44725642015086	-5.61121980530059	14.49896862506180
H	-6.44336250408840	-3.39600551783769	14.49025514789967
C	-14.68041619555338	0.08607823158791	7.39786396446746

O	-14.82544846994348	1.15590701002627	7.93095233903446
O	-15.62643480506198	-0.51656377584106	6.66303117275534
H	-16.38446500293350	0.08914565129278	6.59796162288334
C	-14.73488609684152	0.01922906998798	2.50445566341893
O	-15.73445967829426	-0.43680305971162	2.99581548446873
O	-14.65396468886429	1.26998554376819	2.01852568785813
H	-15.51663056187549	1.69250414012124	2.17328293140499
Hg	-13.60832795430204	2.82893428996546	5.04522275319844

ffCNTPFOA

C	-6.79560604879107	-2.81800867457335	0.09932484826434
C	-7.12539306563624	-1.49084386915135	0.14883552511621
C	-7.58770706404946	-0.89908836451088	1.37904322029217
C	-8.65514475782076	0.03819156179629	1.42292579303123
C	-9.34688751317930	0.47230546854638	0.23132483532680
C	-10.69379712736943	0.66629464554395	0.24882292510243
C	-11.46421375256803	0.46302225688775	1.46369330507159
C	-12.76778394640155	0.00112838906644	1.44216394154415
C	-13.40076908269535	-0.48179877176789	0.22325750076754
C	-13.96053603589865	-1.71826440942847	0.22528059413206
C	-13.85343981117945	-2.54865707255672	1.43179592014781
C	-13.46489059137737	-3.93967010388216	1.35295904858589
C	-13.12579485590757	-4.56237125747710	0.11306442126298
C	-12.14444213796304	-5.52618017336474	0.05349642755136

C	-11.43844112136608	-5.92265080173735	1.23132027256899
C	-10.02184693716674	-6.20283501740392	1.20962125329034
C	-9.24798074148645	-6.11309700954831	0.00366843007731
C	-8.02142593379075	-5.50060631656577	0.01584922481467
C	-7.50558257099302	-4.94441223279035	1.23596174513176
C	-6.91509793029244	-3.63683088305560	1.27774934446712
C	-6.87805001525388	-2.95919386078133	2.53244256932003
C	-7.21079952335572	-1.57012907323011	2.58671715358707
C	-7.57574585667646	-1.00521624120655	3.84706992235939
C	-8.64286435023986	-0.06309538220587	3.89524593180200
C	-9.32292565566269	0.27074913658021	2.67383725832673
C	-10.71573023616814	0.52764113511106	2.70404486010637
C	-11.41479271639997	0.41254696242482	3.94931611198110
C	-12.74004750504339	-0.07513828443765	3.97474666659859
C	-13.52125706140738	-0.38927739289583	2.70419947667588
C	-13.78402564544865	-1.90646876035489	2.66313961376186
C	-13.74150818484113	-2.65112958106405	3.88010813574284
C	-13.38380940482547	-4.03140220026011	3.81527308270003
C	-13.05890609336624	-4.60169960951743	2.54570673227727
C	-12.04205641331688	-5.61216403089946	2.48468451905034
C	-11.39972260197392	-6.00931646826946	3.70137711539903
C	-10.00128716449162	-6.27289445548951	3.67980717071774
C	-9.30283356650564	-6.12782765736064	2.43568013514571
C	-8.01791433793393	-5.48902054300061	2.45077295136547

C	-7.51759072750201	-5.01526464543193	3.70536147988138
C	-6.93072836860986	-3.71917442974338	3.74765237457228
C	-6.84265235097433	-3.04857841106055	5.00453555807100
C	-7.17906427658093	-1.65768206444757	5.05586097852056
C	-7.53024706088879	-1.08033858849103	6.31386845357112
C	-8.59167754736490	-0.12910865564497	6.36159812992001
C	-9.26640530625572	0.20737597129141	5.14860029725096
C	-10.67812907641656	0.43688379045420	5.18127265187101
C	-11.37665174404931	0.33108320454604	6.43092465978893
C	-12.69626215716104	-0.16749144330316	6.41906497384063
C	-13.22791109405247	-0.61008740505842	5.18536681978158
C	-13.74666417934704	-1.98532608115205	5.13834530906894
C	-13.70291652675492	-2.75075743071560	6.33757085557569
C	-13.36300892315163	-4.14220974845373	6.26932339835925
C	-13.03275632353250	-4.71997639923434	5.01157580429788
C	-12.02480123119764	-5.73363761968629	4.95629491626654
C	-11.38352524973933	-6.13471392689394	6.16718400795725
C	-9.97715547233739	-6.38940767698756	6.14575337764071
C	-9.27592727191095	-6.23940577723069	4.91020838605457
C	-8.00290677152490	-5.58354378486638	4.92536558886250
C	-7.49305934689441	-5.10888741733581	6.17266404786997
C	-6.89931138083760	-3.80892227380309	6.21219024457915
C	-6.81978738613329	-3.13057633922260	7.46972592857706
C	-7.12876902841323	-1.73790543138992	7.51987372149928

C	-7.48392740203443	-1.15877527733082	8.77516397805472
C	-8.53720474718929	-0.20358458877524	8.82570202975132
C	-9.23223052764260	0.13749514064089	7.61776148017589
C	-10.62531058906350	0.39344743785111	7.65558823856408
C	-11.31901010542128	0.21578648546712	8.90463383703805
C	-12.61579433578222	-0.30512857495639	8.93726451879591
C	-13.43006824941471	-0.59889515081770	7.68768010532495
C	-13.67860266633921	-2.10949850061835	7.61038058416477
C	-13.68729855414665	-2.86160903847058	8.78542191380133
C	-13.35841113834686	-4.26016297256464	8.72650023300479
C	-13.01952118193862	-4.83316366977190	7.46933717049895
C	-12.01288107568894	-5.85132304316219	7.41891785199823
C	-11.37157842369933	-6.23418319876663	8.63013614571025
C	-9.96086865764498	-6.47088474323392	8.61225173275432
C	-9.25432443683227	-6.32957794097992	7.37971271078907
C	-7.98184349547161	-5.67455051981712	7.39406584828447
C	-7.48124967421401	-5.18890843119548	8.63890775203394
C	-6.88648423449675	-3.88974116750323	8.67743578980480
C	-6.80552516619858	-3.21235598915923	9.93636613377233
C	-7.10328298167718	-1.82549054238676	9.98615955861382
C	-7.41880618002407	-1.23638661250159	11.25308440812316
C	-8.46851637410951	-0.25546251239473	11.30595092407821
C	-9.15626018681406	0.06699653251533	10.08883583815373
C	-10.55643205580203	0.27318431921096	10.13125436757284

C	-11.22375075649306	0.14806080671561	11.39005489520738
C	-12.50613040651629	-0.49705426263629	11.39957566210752
C	-13.05588088674556	-0.91884882055696	10.14776270055880
C	-13.64569893346232	-2.21241766351919	10.08492503008766
C	-13.70415214264619	-2.99036056919605	11.27471225377914
C	-13.39438250290022	-4.40120708591957	11.20387553161730
C	-13.01486756446952	-4.94739375907935	9.92941412410161
C	-12.00062867435189	-5.94020675467819	9.88133841572306
C	-11.36555827826639	-6.32748132303285	11.10550523786510
C	-9.94558777197788	-6.55040743234264	11.09058434720654
C	-9.24523027962540	-6.38989688404210	9.84929404175162
C	-7.98558132173066	-5.73533473565656	9.86289368801465
C	-7.47752349696352	-5.26360626455608	11.11817098856875
C	-6.86199252681828	-3.96482613387533	11.15543886428663
C	-6.72624441393530	-3.29724435636374	12.40269770752420
C	-7.00428281880983	-1.88061401791682	12.45250154272475
C	-7.30314296726268	-1.20719508647309	13.68331887394295
C	-8.30302619258808	-0.26954383005437	13.73428792209145
C	-9.06437229621572	0.05191478024413	12.56022764017213
C	-10.49002419325413	0.25527154352343	12.60646870614804
C	-11.23582660851669	0.11813807938003	13.82641812883887
C	-12.44605112808106	-0.52741229315031	13.83014799495360
C	-12.98993370742405	-1.06032674638609	12.61146054364828
C	-13.62636983427300	-2.34955107669965	12.54894104978649

C	-13.76674718239752	-3.18354855333881	13.70999239489386
C	-13.51390419834669	-4.52747671875750	13.63474292716560
C	-13.08543416182019	-5.10979653900938	12.38999250925018
C	-12.02376491090196	-6.09408702024679	12.34340681559618
C	-11.34114472584579	-6.52540513145423	13.52649443459834
C	-9.98122174215832	-6.72484961366687	13.51380453597933
C	-9.22566428276670	-6.51463378955577	12.31572732562058
C	-7.94372567571472	-5.84326065877783	12.32993970884056
C	-7.35798482483108	-5.35520006786336	13.54431425090871
C	-6.76660897505806	-4.11655857830468	13.57924420750744
H	-6.58570654833132	-3.28132461743531	-0.86656260152198
H	-7.16703714262964	-0.91755904573173	-0.77904679212708
H	-8.80696275799015	0.53733471242148	-0.71531897066735
H	-11.21822544919644	0.88479109120547	-0.68335586426144
H	-13.34450176145849	0.09431133526852	-0.70461527547770
H	-14.39045877234748	-2.13774971082485	-0.68609247094715
H	-13.54570502616116	-4.17823583133526	-0.81749712565405
H	-11.80881470026568	-5.87614614616514	-0.92403910452045
H	-9.69502058490322	-6.38976611864332	-0.95280446993957
H	-7.51695895845331	-5.30001251781424	-0.93116500146900
H	-6.83761940188748	-1.53924919437380	14.61303205501442
H	-8.60930382525352	0.12623056504570	14.70426453721592
H	-10.77697142915954	0.38992123633893	14.77870856923911
H	-12.92360326249011	-0.75653188512742	14.78469672350201

H	-13.94407170164396	-2.72796815083763	14.68637839764649
H	-13.50244426037489	-5.12276796668673	14.54914138112301
H	-11.86907564947811	-6.54919141633806	14.48098949192436
H	-9.46436739262566	-6.89878472431991	14.45930057180091
H	-7.51621944868680	-5.89372748148319	14.48032180751275
H	-6.46655756059336	-3.70077407371531	14.54278198415646
C	-14.74809706504512	0.20969393616411	7.74412489876531
O	-14.83040470780956	1.31104517827840	8.23248214322048
O	-15.75622626667506	-0.43247767650992	7.15447768066327
H	-16.54284363511001	0.13946115500523	7.14979175972867
C	-14.86294331884251	0.38666902264458	2.81252907048349
O	-15.81889211062751	0.00835382877637	3.44084773300502
O	-14.81381354382194	1.55859797104388	2.16719442586707
H	-15.67068414146329	1.99865389497981	2.29832369282065
F	-16.07659036913855	2.56928140578001	5.98939491130491
F	-17.05152986703994	2.91082584802639	3.47156897163493
F	-17.57896946987997	1.84547740888770	1.03597277396020
O	-16.61136127673786	3.05496983676364	9.95206753168697
F	-17.83935511034444	1.52181878122072	8.02918163894139
F	-17.91942156297112	0.91310359443025	5.40127026151852
F	-18.66278546794231	0.52303540945513	2.99835985435810
F	-19.88544533466320	0.25455441812457	0.56699125757417
C	-16.53597726803784	3.33546250442955	8.79304555063780
C	-17.31284924806435	3.01261867461753	6.27228209431123

C	-18.32741925856746	2.72194642127141	3.89205794051267
C	-18.82671161028672	2.21864244897983	1.39102608206261
F	-19.38609642400796	1.81231786090199	-0.85514351237495
C	-17.61317280883672	2.83997014381117	7.79083417069709
C	-18.30351797091605	2.20073407409030	5.36521661080225
C	-19.06503859234217	1.79025558912376	2.87392248186460
C	-19.81909727962067	1.57079101475352	0.38092378610653
F	-17.39418408134446	4.32172105100810	5.97487063625981
F	-18.93156242383195	3.55223712790068	1.26726380572429
F	-18.95617769758188	3.90620477100887	3.88586031961928
H	-14.98286863997681	4.37446125019527	8.89363341751610
O	-15.65028115126976	4.14560362999979	8.22297141088792
F	-21.03195994709117	2.09707463383368	0.52194088391253
F	-18.75019957138212	3.51254714385240	8.06590733410760
F	-19.55924337419985	2.29191201929055	5.83757883277168
F	-20.38386478695423	1.86269021107442	3.14422360741996

CNTPAN

C	-6.61942524327033	-2.81826857243656	0.10131081241990
C	-6.94890000599491	-1.49303800114043	0.10505406286328
C	-7.43527392611523	-0.86613633867173	1.31199640287110
C	-8.52983788081271	0.05329691858175	1.30278806086354
C	-9.21956855881590	0.41195165454779	0.08580670288716
C	-10.58152052404942	0.50970266109336	0.06953347134471

C	-11.34515664267599	0.25615077492649	1.26873565519605
C	-12.55860075194525	-0.49907939869244	1.25009168353401
C	-13.09760946649549	-1.05411368011300	0.03070809686213
C	-13.61015926879720	-2.31965574826400	0.01780052676916
C	-13.61770727616848	-3.11479976871013	1.22326666795959
C	-13.27303170060261	-4.50199336372068	1.21944956080010
C	-12.89594517569962	-5.19491817784289	0.00989457044031
C	-11.85125452730401	-6.07417397055410	0.01689983004953
C	-11.11391016328773	-6.31970137354369	1.23403896593398
C	-9.68827949571888	-6.42204278326273	1.25031287065980
C	-8.89618099040716	-6.28422115395915	0.05066811086721
C	-7.73682068621546	-5.56296603923408	0.06907875479723
C	-7.29211493955942	-4.93057612654110	1.28885065150999
C	-6.75395016261502	-3.60635342162380	1.30429119190328
C	-6.74221776232508	-2.89431593461340	2.54072935118446
C	-7.09029508580286	-1.49664437242838	2.54458397740654
C	-7.49700366370182	-0.90492088447565	3.78009699227061
C	-8.58000844310859	0.01168071837910	3.77085390474524
C	-9.22121768665425	0.29757429006771	2.52684584449352
C	-10.65684665577546	0.40208888157131	2.50967914952459
C	-11.36320710399859	0.21343667719207	3.73730331254566
C	-12.56656695892814	-0.53742376832336	3.71877901327344
C	-13.01963793510364	-1.07078759569519	2.47322467565208
C	-13.55929329840178	-2.40525740773473	2.45947171077902

C	-13.61162039750411	-3.12572662369828	3.69203247617700
C	-13.26960469259295	-4.50229839971514	3.68824108083917
C	-12.88760918681357	-5.10804493932703	2.45204455331217
C	-11.78680043790903	-6.03553283763339	2.45956376005620
C	-11.13535957370478	-6.30184160969640	3.70289319252350
C	-9.72076790404847	-6.40539778618242	3.71906893843696
C	-9.00953896011851	-6.23705480954720	2.49128409668105
C	-7.78777370847192	-5.47586955255654	2.51079923919285
C	-7.35192246942961	-4.93075191957227	3.75711028165167
C	-6.82199476085724	-3.61448754506363	3.77256186761012
C	-6.79044371823476	-2.90059690527331	5.02133181637807
C	-7.13246955581452	-1.52760039181461	5.02508769265083
C	-7.51713418038726	-0.91326280244646	6.26032367824414
C	-8.60558483303205	0.01434389237233	6.25219807725366
C	-9.26515363341566	0.28093738407743	5.00754757599785
C	-10.67672877201871	0.38341652804045	4.99088065004000
C	-11.39735249413606	0.21836854666344	6.21959727705048
C	-12.61101776661179	-0.54007660969537	6.20075827026322
C	-13.04822274418660	-1.09762073980244	4.95423609532801
C	-13.57745495951658	-2.41031502782639	4.94052173144792
C	-13.65834027368105	-3.13753473719339	6.17341137607859
C	-13.31326095435021	-4.52658556996259	6.16954795051209
C	-12.90279773916648	-5.12487394850547	4.93304422651378
C	-11.82123305536228	-6.03785486688296	4.94061794901467

C	-11.17255401416971	-6.33304310224785	6.18474404900074
C	-9.74529102883742	-6.43864407536806	6.20126853263630
C	-9.03239389832100	-6.24275621240501	4.97260421271256
C	-7.83057149194018	-5.49525126639502	4.99158345968898
C	-7.36938122683078	-4.95874054827643	6.23854722508606
C	-6.83787249204865	-3.63061818796757	6.25304158019113
C	-6.80821582392017	-2.92020296433010	7.48682937616498
C	-7.15660001796882	-1.53412999704528	7.49015385169623
C	-7.55959308070132	-0.93264180508512	8.72646802198206
C	-8.63751343240239	-0.01536421252312	8.71938605858321
C	-9.28614648664173	0.28048520218841	7.47589213909882
C	-10.71349919001509	0.38459079740039	7.45928169520201
C	-11.42539355953447	0.18734922385958	8.68803257956247
C	-12.62583007210865	-0.56259595054380	8.66918947620540
C	-13.08776584989225	-1.09897299625722	7.42231367280964
C	-13.62294830037657	-2.42650187304204	7.40813993154040
C	-13.67233701802764	-3.15600561211513	8.64129026221181
C	-13.33112441487307	-4.52973847911712	8.63743176261977
C	-12.94738006259867	-5.14469540090676	7.40056121746799
C	-11.85373751021566	-6.06811093684209	7.40847757663415
C	-11.19322895766475	-6.33314354235523	8.65311890744664
C	-9.78165741121530	-6.43710320745201	8.66974419214551
C	-9.06113757962353	-6.27359179870445	7.44098683986199
C	-7.84567359964426	-5.51786311519361	7.46008418523268

C	-7.40873921560544	-4.95949181491883	8.70624955836667
C	-6.88185957260460	-3.64595884442320	8.71954133778341
C	-6.84517378817882	-2.92936411827715	9.96666984432024
C	-7.18745805670501	-1.55298776878989	9.97040057514139
C	-7.56732150442350	-0.94569164200438	11.20623387847186
C	-8.66849986274646	-0.01849988324259	11.19947459868597
C	-9.32167189227040	0.24884752831158	9.95716152256682
C	-10.73626766389582	0.35140803676439	9.94124938885050
C	-11.44643935865883	0.18245708146414	11.16917420930754
C	-12.66808576629105	-0.57895503185893	11.15008958564461
C	-13.10413813837973	-1.12615789694573	9.90432651534082
C	-13.63524119055784	-2.44119509948584	9.89004381831721
C	-13.71248956273927	-3.16056775552389	11.12193323304028
C	-13.36569032324803	-4.55770589694488	11.11797844138890
C	-12.96225576323806	-5.15071527001950	9.88241794961263
C	-11.87811808618534	-6.06509000358694	9.89046909563307
C	-11.23575241436499	-6.35224967613585	11.13396164341319
C	-9.80004089233072	-6.45618922952381	11.15090833410354
C	-9.09417722323821	-6.26800563273346	9.92325325269493
C	-7.89011529615644	-5.51852076721674	9.94182270825644
C	-7.43647213325532	-4.98348334235963	11.18654131884674
C	-6.89579517396846	-3.64913976342949	11.19931911736923
C	-6.83668270793240	-2.93884031483441	12.43484687308316
C	-7.18079484638806	-1.55119025491500	12.43836216972682

C	-7.55717989881157	-0.85832966982950	13.64800681797240
C	-8.60248581126888	0.02025735113602	13.64185834606284
C	-9.34063839764879	0.26544465099865	12.42524464590176
C	-10.76657171114977	0.36785620234105	12.40955288731905
C	-11.55775212506988	0.23064976802963	13.60971878660123
C	-12.71707876678578	-0.49064493104231	13.59174091927853
C	-13.16232075237204	-1.12343051492745	12.37241006632769
C	-13.69903278095609	-2.44839761343216	12.35785573031608
C	-13.83097150694728	-3.23500186257426	13.56160372764743
C	-13.50212578720855	-4.56030612269415	13.55783517317160
C	-13.01932715319538	-5.18755641549232	12.35010806520997
C	-11.92577095277499	-6.10830834192919	12.35839072979859
C	-11.23551863268268	-6.46709726875313	13.57501231421750
C	-9.87357058326686	-6.56428211250897	13.59103640139528
C	-9.11094903838326	-6.31002703758176	12.39147050961635
C	-7.89757612838155	-5.55417261983637	12.40986895573383
C	-7.35863011511642	-4.99833425011209	13.62882994950578
C	-6.84494529763431	-3.73314474794190	13.64073548861085
H	-6.37929346405341	-3.30829690392996	-0.84405949530624
H	-6.96722574422179	-0.94251141934841	-0.83733879897936
H	-8.66606957456115	0.47738638640794	-0.85270647136903
H	-11.09732797949095	0.65202529513809	-0.88186316452820
H	-12.97856662549466	-0.51398665781348	-0.91034264266932
H	-13.89380042558684	-2.77370230031363	-0.93342920234614

H	-13.36007696829048	-4.92112777980051	-0.93936379860130
H	-11.49463647419387	-6.49089891574492	-0.92683484730569
H	-9.28756596042126	-6.64556514826071	-0.90207460421022
H	-7.21798119569266	-5.35773412719102	-0.86907912725469
H	-7.09142740634516	-1.13120039847274	14.59668730405334
H	-8.95856921689616	0.43687743149884	14.58581303650629
H	-11.16577883950904	0.59221935367016	14.56211275849124
H	-13.23568613762749	-0.69566730922818	14.53005478835956
H	-14.06892852305642	-2.74418871265065	14.50706613736733
H	-13.48170110367550	-5.11044765629860	14.50036082012155
H	-11.78891611087750	-6.53309127219886	14.51352951780192
H	-9.35721036931729	-6.70658561445285	14.54212342257075
H	-7.47827087087622	-5.53741749649375	14.57038291446964
H	-6.56073406466639	-3.27866684814295	14.59154544894246
H	-2.87585977038347	-0.86712222033576	3.46937725402791
C	-3.22758280608313	-0.99550224316932	5.56211723222797
C	-3.70142195680912	-1.12493864792159	4.14373404223203
N	-4.28651450618012	-0.24995127595613	8.30764510418502
O	-4.73006236908666	0.53775953748713	7.53839394873692
O	-3.82430678734164	-1.56701104737948	7.73363399418782
O	-4.16926530208590	-1.62706953518952	6.38554170655480
O	-4.11466951561795	-0.24476622407763	9.48170281977494
O	-2.25805891387374	-0.45030965349675	5.98546706584032
H	-4.54031047409564	-0.42965088338600	3.98367720582839

H -4.07599939927738 -2.13743817897853 3.93920790418945

CNTNO₂

C	-6.62717	-3.10746	0.04641
C	-6.88955	-1.75436	0.04763
C	-7.31101	-1.09841	1.24341
C	-8.37623	-0.10660	1.24109
C	-9.05735	0.26547	0.04290
C	-10.42550	0.43205	0.03844
C	-11.18420	0.23679	1.23193
C	-12.45734	-0.46906	1.22718
C	-13.01778	-1.00515	0.02883
C	-13.60079	-2.25417	0.02635
C	-13.65355	-3.03231	1.22190
C	-13.37571	-4.46124	1.22178
C	-13.03658	-5.16335	0.02609
C	-12.02789	-6.10271	0.02803
C	-11.30628	-6.38946	1.22583
C	-9.86143	-6.56624	1.22946
C	-9.08619	-6.46171	0.03536
C	-7.88091	-5.79308	0.03939
C	-7.38761	-5.19447	1.23772
C	-6.77256	-3.87519	1.24111
C	-6.73703	-3.16025	2.46811

C	-7.01051	-1.74979	2.46931
C	-7.36706	-1.12872	3.71457
C	-8.40876	-0.15920	3.71242
C	-9.05023	0.15025	2.46495
C	-10.47657	0.32498	2.46011
C	-11.18317	0.18324	3.70339
C	-12.42752	-0.50697	3.69917
C	-12.91441	-1.02647	2.45119
C	-13.52136	-2.32851	2.44861
C	-13.60663	-3.04007	3.69410
C	-13.33424	-4.43672	3.69386
C	-12.98859	-5.06414	2.44828
C	-11.93759	-6.04354	2.45032
C	-11.29013	-6.34186	3.69788
C	-9.87785	-6.51585	3.70152
C	-9.17122	-6.38318	2.45738
C	-7.91475	-5.68676	2.46151
C	-7.43375	-5.16195	3.70949
C	-6.83244	-3.87224	3.71243
C	-6.73009	-3.16359	4.94518
C	-7.00850	-1.75131	4.94550
C	-7.36878	-1.12989	6.17438
C	-8.41651	-0.15318	6.17175
C	-9.05786	0.15918	4.94168

C	-10.48670	0.33858	4.93738
C	-11.19472	0.19697	6.16424
C	-12.44656	-0.49771	6.16010
C	-12.93543	-1.01966	4.92910
C	-13.54250	-2.32568	4.92643
C	-13.62833	-3.04031	6.15477
C	-13.35403	-4.44553	6.15439
C	-13.00615	-5.07507	4.92584
C	-11.95249	-6.05685	4.92792
C	-11.30288	-6.35745	6.15858
C	-9.88205	-6.53276	6.16245
C	-9.17243	-6.39957	4.93522
C	-7.91278	-5.70186	4.93925
C	-7.42940	-5.17498	6.17066
C	-6.82551	-3.87749	6.17353
C	-6.74186	-3.16260	7.41450
C	-7.01869	-1.75826	7.41502
C	-7.36366	-1.12611	8.64182
C	-8.41675	-0.14292	8.63973
C	-9.06922	0.15515	7.41028
C	-10.48973	0.33277	7.40639
C	-11.19818	0.19929	8.63371
C	-12.45775	-0.49935	8.62959
C	-12.94085	-1.02701	7.39865

C	-13.54447	-2.32528	7.39579
C	-13.63936	-3.03899	8.62395
C	-13.36387	-4.45269	8.62340
C	-13.00764	-5.07746	7.39488
C	-11.96038	-6.05382	7.39703
C	-11.31497	-6.36281	8.62761
C	-9.88555	-6.53913	8.63165
C	-9.17747	-6.39698	7.40482
C	-7.92475	-5.70365	7.40916
C	-7.43534	-5.18198	8.63994
C	-6.82693	-3.87645	8.64269
C	-6.76384	-3.16057	9.87411
C	-7.03491	-1.76359	9.87366
C	-7.38006	-1.13564	11.11918
C	-8.43063	-0.15580	11.11708
C	-9.07843	0.14250	9.86937
C	-10.49131	0.31537	9.86638
C	-11.19744	0.18245	11.11077
C	-12.45373	-0.51432	11.10709
C	-12.93520	-1.03985	9.85935
C	-13.53601	-2.32973	9.85647
C	-13.63159	-3.04035	11.10171
C	-13.35745	-4.45053	11.10111
C	-13.00206	-5.07245	9.85543

C	-11.96129	-6.04277	9.85759
C	-11.31893	-6.35114	11.10540
C	-9.89305	-6.52615	11.10953
C	-9.18801	-6.38371	9.86552
C	-7.94352	-5.69398	9.86973
C	-7.45586	-5.17415	11.11746
C	-6.84907	-3.87195	11.11973
C	-6.71636	-3.16784	12.34601
C	-6.99313	-1.73845	12.34562
C	-7.33203	-1.03631	13.54120
C	-8.34015	-0.09628	13.53916
C	-9.06166	0.19033	12.34140
C	-10.50703	0.36670	12.33829
C	-11.28171	0.26215	13.53238
C	-12.48724	-0.40655	13.52893
C	-12.98074	-1.00559	12.33119
C	-13.59642	-2.32496	12.32826
C	-13.74099	-3.09209	13.52321
C	-13.47838	-4.44529	13.52265
C	-13.05710	-5.10163	12.32720
C	-11.99217	-6.09429	12.32944
C	-11.31062	-6.46580	13.52728
C	-9.94242	-6.63323	13.53124
C	-9.18464	-6.43808	12.33747

C	-7.91162	-5.73172	12.34165
C	-7.35110	-5.19492	13.53958
C	-6.76841	-3.94570	13.54170
H	-6.46541	-3.61061	-0.90859
H	-6.92811	-1.22569	-0.90651
H	-8.52521	0.26178	-0.91006
H	-10.93657	0.55603	-0.91802
H	-12.84585	-0.50361	-0.92525
H	-13.87305	-2.70485	-0.92974
H	-13.45871	-4.84769	-0.92970
H	-11.68192	-6.50417	-0.92617
H	-9.51452	-6.76706	-0.92102
H	-7.39066	-5.58800	-0.91401
H	-6.90937	-1.35147	14.49692
H	-8.68650	0.30479	14.49337
H	-10.85318	0.56748	14.48867
H	-12.97684	-0.61157	14.48267
H	-13.90193	-2.58849	14.47812
H	-13.43868	-4.97310	14.47722
H	-11.84206	-6.46098	14.48066
H	-9.43088	-6.75611	14.48759
H	-7.52235	-5.69633	14.49385
H	-6.49579	-3.49482	14.49759
N	-5.55229	1.10927	6.19897

O	-5.17758	1.18988	7.32952
O	-5.01946	1.24120	5.13919

CNTHN₃

C	-6.64096711608915	-3.13011226386466	0.00174953265399
C	-6.89025232694336	-1.78762761983439	0.00542052351170
C	-7.32039817023357	-1.13001784467765	1.21706053140991
C	-8.35840141144976	-0.14723436552638	1.21940096550542
C	-9.04124461696770	0.24921736090465	0.01026426303363
C	-10.39527851327841	0.42538959948986	0.01025231950740
C	-11.15700866949578	0.21720762347531	1.21935957706920
C	-12.41239239211866	-0.46655951613438	1.21717618743499
C	-12.99729147348048	-0.99147553394551	0.00568083020871
C	-13.58453750551942	-2.22423583272307	0.00234359772656
C	-13.62629895747185	-3.01464316983230	1.21021898313363
C	-13.36518283161927	-4.42012486302108	1.20669847369546
C	-13.04373059115223	-5.13695526737427	-0.00503433536950
C	-12.05222501264235	-6.07578233768845	-0.00733040938192
C	-11.31603492385134	-6.36063638197958	1.20195135237207
C	-9.89847262273891	-6.54524011273281	1.20162614477304
C	-9.11451243516657	-6.45779697685462	-0.00798693994409
C	-7.91534464324496	-5.80470077209672	-0.00600833898316
C	-7.41979256758255	-5.19529751464911	1.20577601801624
C	-6.80493997119245	-3.90473336230742	1.20949134383725

C	-6.73343960150532	-3.19168989384824	2.44292066217126
C	-6.99621167128440	-1.77623481891470	2.44680836837437
C	-7.34853261353152	-1.15746404873114	3.68530280015446
C	-8.37848641496164	-0.18224615951070	3.68766992073134
C	-9.01837116540028	0.13860018701605	2.45137386774772
C	-10.44593339169195	0.32445757787047	2.45135217213711
C	-11.14691962965064	0.17838488577132	3.68760569717772
C	-12.39255040272689	-0.49991843365816	3.68550353224028
C	-12.89191360064665	-1.00747592533767	2.44702148797044
C	-13.51102463175148	-2.30707382845609	2.44351765242301
C	-13.59256540410742	-3.02038434780948	3.67867634625432
C	-13.33315858287024	-4.41478398754451	3.67517825961554
C	-13.00199556517217	-5.04502679670030	2.43658435898721
C	-11.95672333355454	-6.03487781102669	2.43417419080876
C	-11.30638695302985	-6.33415542930835	3.67050814783728
C	-9.90001278134679	-6.51781521686956	3.67019608207864
C	-9.19516147491169	-6.39485085524845	2.43358279129506
C	-7.93100556705180	-5.70626005534865	2.43563942733574
C	-7.44841230869481	-5.18289174109028	3.67422791353233
C	-6.83863638263254	-3.90233676890967	3.67780349563358
C	-6.74299039372790	-3.18831273176782	4.92384173218125
C	-7.00130758918760	-1.79648437795603	4.92765206006846
C	-7.33390566200644	-1.15777767146786	6.16712891852592
C	-8.37373582129222	-0.17339324191278	6.16937698063190

C	-9.03246663146096	0.12679101120855	4.93225090037693
C	-10.43614095116914	0.30965759258650	4.93225631774273
C	-11.15081868521374	0.18971840975957	6.16935066814913
C	-12.40801296571086	-0.49435411803834	6.16735660910463
C	-12.89252904711480	-1.02741733060642	4.92792210889521
C	-13.50067317251514	-2.30546731588046	4.92454322549984
C	-13.61080292525236	-3.02344165129741	6.16066162267613
C	-13.34875876598316	-4.43060373014008	6.15708823478558
C	-12.98887765302324	-5.05482640056026	4.91761268680879
C	-11.96115410906607	-6.02807018870215	4.91525706451770
C	-11.31530231070906	-6.35627148682824	6.15243653605240
C	-9.89606356943090	-6.54193609379724	6.15218385365744
C	-9.18809542318088	-6.39032401355824	4.91467502375904
C	-7.94493043740335	-5.71371117912262	4.91661561082812
C	-7.43616440482555	-5.20361984561076	6.15602293139994
C	-6.82140408393037	-3.91113675559443	6.15943677525782
C	-6.72866640787329	-3.20110058700987	7.39163015815890
C	-6.99267360228491	-1.79492144369790	7.39542256631349
C	-7.35136733749623	-1.17005862127022	8.63450084222915
C	-8.37912027629537	-0.19684232733698	8.63686427443558
C	-9.02525392387247	0.13081187500672	7.39990836060476
C	-10.44393867486433	0.31829989436239	7.40009255984699
C	-11.15165302963172	0.16743358920242	8.63761456257270
C	-12.39461191338789	-0.50952049292147	8.63557393690551

C	-12.90300950565082	-1.02029135052953	7.39614507462282
C	-13.51784561385858	-2.31281459178905	7.39267091906890
C	-13.59582683142207	-3.03501838685643	8.62872530405066
C	-13.33655579225748	-4.42647673045367	8.62513655274502
C	-13.00486216383763	-5.06607672018207	7.38563648225755
C	-11.96556793743810	-6.05029047109978	7.38328091334604
C	-11.30597256660091	-6.34950098010932	8.62057099339350
C	-9.90254767067607	-6.53322187619047	8.62041601157202
C	-9.18859891475475	-6.41344967815857	7.38286139547284
C	-7.93135816930183	-5.72938413263126	7.38484543789906
C	-7.44615575783822	-5.19670526854584	8.62439015155991
C	-6.83779095916093	-3.91883639128129	8.62783231579389
C	-6.74575199743986	-3.20331313372512	9.87329411453989
C	-7.00537131581169	-1.80869909648671	9.87647651525092
C	-7.33614944939105	-1.17760637857627	11.11499297344747
C	-8.38160848117494	-0.18769374608854	11.11732316595267
C	-9.03260576669046	0.11114279393406	9.88109865492885
C	-10.43917821990728	0.29502321070410	9.88171970192876
C	-11.14347652182608	0.17215224160692	11.11846840187996
C	-12.40782479672379	-0.51618877283757	11.11659064424559
C	-12.89079093712521	-1.03987448314278	9.87817068957913
C	-13.50017768026117	-2.32059734988449	9.87467000147103
C	-13.60480270202866	-3.03085198044456	11.10982693235299
C	-13.34156475899450	-4.44612854055071	11.10613373543572

C	-12.98919597410344	-5.06488309469058	9.86754907754441
C	-11.95937235249048	-6.04015662010147	9.86524496322518
C	-11.31952092395008	-6.36103305646924	11.10166745894910
C	-9.89207752566256	-6.54734288436663	11.10157595064012
C	-9.19142944387361	-6.40181914744505	9.86503420493859
C	-7.94563825695005	-5.72385957286446	9.86704947407507
C	-7.44606278808247	-5.21580364375714	11.10540100800931
C	-6.82729037631945	-3.91599273404314	11.10866574051461
C	-6.71190224677006	-3.20773050865547	12.34170567169258
C	-6.97257357124495	-1.80214102014370	12.34499097599628
C	-7.29362096059658	-1.08469156281857	13.55649378685703
C	-8.28518251945954	-0.14591854569993	13.55870507923079
C	-9.02198251403446	0.13840915706699	12.34964597707043
C	-10.43958680033330	0.32263525895598	12.35023749705624
C	-11.22326418790179	0.23560609772880	13.56003489251400
C	-12.42248566772122	-0.41744146886633	13.55822293815314
C	-12.91859315661248	-1.02687998782400	12.34667382779828
C	-13.53328071040871	-2.31752113028654	12.34318004088465
C	-13.69690700694610	-3.09191847297882	13.55101085222537
C	-13.44738192636601	-4.43443060929254	13.54748468296232
C	-13.01742383774452	-5.09220784777556	12.33594705864823
C	-11.97938030387758	-6.07510172920078	12.33365073145655
C	-11.29640768860016	-6.47123801820087	13.54275711586515
C	-9.94235511952768	-6.64773198303879	13.54271779336615

C	-9.18078789815508	-6.43990925332118	12.33351930381949
C	-7.92535726367554	-5.75620542013137	12.33548318815905
C	-7.34059687333336	-5.23055397365588	13.54673407185867
C	-6.75340487380393	-3.99772997404486	13.54981694615523
H	-6.44378961301423	-3.63649387336848	-0.94489559966467
H	-6.88902076076700	-1.23913065301520	-0.93827747196633
H	-8.49596354366006	0.28210613564255	-0.93472205482244
H	-10.91384118614421	0.59680285820097	-0.93481226551524
H	-12.85662542860376	-0.46172795024300	-0.93825073650653
H	-13.90519094787397	-2.66296728752378	-0.94430215754253
H	-13.50218266087674	-4.83853840371859	-0.94961145128235
H	-11.73162796765871	-6.51510134990653	-0.95372212167575
H	-9.53767515642123	-6.79937501305220	-0.95440544415817
H	-7.39642042231710	-5.63308188945380	-0.95082477532658
H	-6.83460242498881	-1.38223137245624	14.50105434273052
H	-8.60509088819387	0.29403447549914	14.50502162445991
H	-10.80001179431389	0.57728766847060	14.50635839469724
H	-12.94111748218764	-0.58874083860409	14.50326843678562
H	-13.89362503204794	-2.58552838614425	14.49775339916214
H	-13.44806734930758	-4.98242621229386	14.49149099262354
H	-11.84133234457500	-6.50365465074157	14.48798418712456
H	-9.42384531830151	-6.81852138775907	14.48792937011359
H	-7.48111784729278	-5.75980818270826	14.49097211349868
H	-6.43282045128241	-3.55878518276000	14.49636874237066

N	-5.62704268419030	1.62301308395280	7.52282759834742
H	-5.43851898846726	0.84166536400426	6.89232116701309
H	-5.65281163684740	1.21336438569790	8.45829515383309
H	-6.59044279527496	1.89839407350053	7.32443624653449

90⁰CNTPFOA

C	-4.63351838040414	-2.60006435749447	1.36057499873767
C	-4.75274058703652	-1.24810722108939	1.51050874962546
C	-5.38214311786748	-0.70010408849535	2.68910963231895
C	-6.30183102236656	0.39139470382034	2.62235931643429
C	-6.65823116556839	1.02295645819880	1.37368115989532
C	-7.95784925595456	1.35722943412042	1.11997498292661
C	-8.98519080918200	1.09127158241059	2.10005841901573
C	-10.26674000158985	0.56991899434382	1.74050700684006
C	-10.61543952217843	0.27150305561232	0.37141809752507
C	-11.29807828410653	-0.87160179758537	0.06828779722329
C	-11.67718016063905	-1.79273546644200	1.11383333152602
C	-11.54964179954195	-3.20819399674730	0.95952304536320
C	-11.03760217338023	-3.80409196498399	-0.25206193458753
C	-10.15988922137975	-4.84817086098627	-0.18832945999862
C	-9.73607863324848	-5.36651500051079	1.09105310604828
C	-8.37589571632758	-5.71965920142827	1.35358209314885
C	-7.34167846319830	-5.57869246635214	0.35560132613189
C	-6.11751602669872	-5.08009375118368	0.69826326053177

C	-5.84504174526291	-4.69089248091691	2.06181131350111
C	-5.13075292720931	-3.49428885370657	2.38023377033597
C	-5.26702525805490	-2.95426538109704	3.69328560343257
C	-5.39744924935828	-1.52905691948270	3.84972990101290
C	-5.95985417249916	-1.03381635095388	5.06463980243209
C	-6.87481105089728	0.04581323161531	4.99752293530940
C	-7.19083533764865	0.59513875439115	3.71884013549089
C	-8.55770322529449	0.95627393849581	3.45400809462899
C	-9.52458720151755	0.74931355909797	4.48528771901957
C	-10.79668313279030	0.23363801114887	4.12884801574152
C	-11.05446490779737	-0.05459359518005	2.75349929511295
C	-11.77230079516552	-1.26077707493211	2.43404457558732
C	-12.18696828660970	-2.10566086520288	3.50923560322060
C	-12.05924508702597	-3.50994417121791	3.35610376243868
C	-11.52338835874849	-4.01847792075519	2.13328656868485
C	-10.59815846227719	-5.11925011273673	2.20035954007795
C	-10.26496242695153	-5.64526160238812	3.48614351657615
C	-8.91591587090176	-5.99742556885356	3.74657908336096
C	-7.94875795708014	-5.80951373602937	2.71171739284374
C	-6.65731918061226	-5.28588709324623	3.07283670358833
C	-6.41131440557273	-4.98335001486956	4.44713065170311
C	-5.70297738464651	-3.79570091535238	4.76256835150793
C	-5.82025780482811	-3.25803514371834	6.09232618541840
C	-5.95342553601587	-1.85760935969231	6.24392887825523

C	-6.49445212367863	-1.34338562939091	7.46671924470651
C	-7.41305271622022	-0.24942403060452	7.40099457055489
C	-7.75063561563972	0.28113095999546	6.11358017656930
C	-9.09563630363633	0.63696494920735	5.85437782211405
C	-10.07118642118808	0.45636060861032	6.88913035843650
C	-11.35474513667398	-0.06506392207510	6.52959177544208
C	-11.60293085325650	-0.37841659921056	5.15241295126726
C	-12.30665705547469	-1.56570833578980	4.83829045768730
C	-12.74904119003513	-2.41231211006036	5.90770470742172
C	-12.61988190877067	-3.82940024316728	5.75275015516885
C	-12.05540036713244	-4.33474134072948	4.53566603672639
C	-11.14541969985171	-5.41695289062200	4.60169115950357
C	-10.82022006040632	-5.97168690124409	5.88312002741535
C	-9.45890753599626	-6.32752483837685	6.14619383249702
C	-8.48568198247100	-6.11274717319295	5.11535230569097
C	-7.21551831536809	-5.59879400218381	5.47058899186907
C	-6.94647337523503	-5.31132382249742	6.84943968183148
C	-6.23196044752662	-4.11256709754229	7.16727368376032
C	-6.34945315154452	-3.57491710187094	8.48206177566379
C	-6.48357849159604	-2.15924830844018	8.63343218708474
C	-7.03973545075757	-1.64720984609278	9.85406327769566
C	-7.95407905145595	-0.56502622118927	9.78678231395831
C	-8.28115081348871	-0.01367379228534	8.50543896525012
C	-9.64139943222848	0.34511638497959	8.24364536145148

C	-10.61323514675985	0.13038997627925	9.27468215312357
C	-11.88215527441830	-0.38704703829922	8.91948558187933
C	-12.15220215398042	-0.67550257739174	7.54108819369171
C	-12.86495507339867	-1.87538998461492	7.22304121256118
C	-13.27692743123566	-2.73011694650379	8.29773853192967
C	-13.14966285134401	-4.13147310135028	8.14422123077361
C	-12.61353777380114	-4.64841363724982	6.91922552950397
C	-11.69382505540385	-5.74311685465994	6.98587221785149
C	-11.35300732774095	-6.27130782412013	8.27436396198753
C	-10.00675110492844	-6.62220850264764	8.53505002804596
C	-9.03037478980892	-6.43928190606564	7.50112550879497
C	-7.74633372042574	-5.91915954320912	7.86072611878457
C	-7.49855683794397	-5.60532052668749	9.23796874842825
C	-6.79333875031505	-4.41930928346819	9.55220063882932
C	-6.91088379358408	-3.87826226166884	10.88118928795136
C	-7.03568945389571	-2.47314947279258	11.03547843211174
C	-7.57111772564475	-1.96266250820468	12.25811336318239
C	-8.49687742835756	-0.86165686687882	12.18912605686121
C	-8.83146992198565	-0.33622075558286	10.90306164459771
C	-10.18103356561289	0.01466838902296	10.64264945532505
C	-11.14702206671886	-0.17469861235139	11.67790214439868
C	-12.43806492587876	-0.69946835522811	11.31718887717416
C	-12.68428546676466	-1.00369601013971	9.94313516036322
C	-13.39179139083626	-2.19185820911819	9.62775629355260

C	-13.82862757470034	-3.03146682489401	10.69798900720895
C	-13.70145707338123	-4.45679789321066	10.54126425485205
C	-13.14363413306481	-4.95569128754153	9.32424362797286
C	-12.23242645724056	-6.04060956803783	9.39026755269991
C	-11.91244764267427	-6.58707382318745	10.67099698006572
C	-10.54304289213779	-6.94288498823067	10.93654820561121
C	-9.57756920323754	-6.73251701329775	9.90471712787702
C	-8.30574785483725	-6.21566386721604	10.26137361427491
C	-8.04624103959704	-5.92726836662573	11.63650779288571
C	-7.32745540710865	-4.72147358544165	11.95632329558829
C	-7.42117983090349	-4.18909914773856	13.27677894473040
C	-7.54608436783571	-2.77356961463864	13.43187138769791
C	-8.05733429268156	-2.17621763168792	14.64322161488873
C	-8.93392162578033	-1.13134541848751	14.57832831960289
C	-9.35826059995678	-0.61386662748679	13.29855130170437
C	-10.71910461758097	-0.26295565336326	13.03580460660747
C	-11.75304891058830	-0.40313631571529	14.03402607990022
C	-12.97717770731922	-0.90228930926621	13.69171449047256
C	-13.25005828834257	-1.29287717158731	12.32866204877390
C	-13.96418264464002	-2.48981839559378	12.01076038831682
C	-14.45935433526811	-3.38176975544946	13.03273648592457
C	-14.33927735237270	-4.73382696511387	12.88383698506563
C	-13.71630017402594	-5.28423129565298	11.70311504137025
C	-12.79771277629249	-6.37756295185219	11.76977277372015

C	-12.43647921096731	-6.99976302101286	13.02189163332538
C	-11.13743931438322	-7.33670024860705	13.27392997005671
C	-10.11310901651803	-7.07483609679707	12.29039855926603
C	-8.83197169713799	-6.55232157102336	12.64977361043565
C	-8.48208186604931	-6.25374895094317	14.01870796852711
C	-7.79951297624063	-5.11066122100599	14.32216353983381
H	-4.27666332472741	-3.00440638548529	0.41152495450227
H	-4.48506534901484	-0.58944810100430	0.68407675344076
H	-5.91115493791755	1.12142763208212	0.58532797351807
H	-8.23576531519857	1.71197583539456	0.12572074131740
H	-10.22062718394640	0.89089529067435	-0.43600927467171
H	-11.44020962663743	-1.14982386453793	-0.97757461751244
H	-11.24843536192386	-3.33875128346056	-1.21663431317278
H	-9.68134187187569	-5.20297017147639	-1.10296151769603
H	-7.57714520642574	-5.74599344748741	-0.69698943143154
H	-5.39134539290040	-4.85548770619977	-0.08511380855558
H	-7.84667678685317	-2.64083170846079	15.60818050035884
H	-9.41142359100849	-0.77451059933280	15.49270826185005
H	-11.5177793287979	-0.23409343818328	15.08635921769842
H	-13.70327446257390	-1.12541729996777	14.47559627442095
H	-14.81163894499931	-2.97599010862502	13.98283293675576
H	-14.59751399643730	-5.39008577285593	13.71696003868587
H	-13.17654521844505	-7.08261412933620	13.81993907524027
H	-10.85710260926015	-7.68432193370429	14.26994545024017

H	-8.87488803212239	-6.87394465903796	14.82648296548398
H	-7.65628077716168	-4.83312683982786	15.36804712916414
F	-4.82234614953359	3.13060913855701	7.28353430123108
F	-3.69411817177141	4.13699613015225	4.92668409543700
F	-2.65461083606352	4.54145610873482	2.43219515026476
O	-5.46361509510938	1.85188042610301	9.98107679761403
F	-3.09060104056284	3.08117071917457	9.21874184738335
F	-1.99840417670923	3.13515608679240	6.56532679565189
F	-1.42883217187520	2.72150225923058	3.81798714226577
F	-1.33455457995020	2.40698016306809	1.05383823694896
C	-4.51512615782190	1.22807581241530	9.59650204030530
C	-3.99532521384292	2.07333558947607	7.27605553558843
C	-3.57051438796067	2.80247828236828	4.82726536167212
C	-3.14696787615154	3.29923437515193	2.31120196077876
F	-2.79504596411164	3.61708934494819	0.00499513869607
C	-3.41838669376676	1.88143929789380	8.71156386461960
C	-2.93256316754590	2.26177579921542	6.15409809475723
C	-2.72403743539141	2.46676266121094	3.56155677072947
C	-2.62697492452380	2.71207792710855	0.96511585361594
F	-4.70133158123625	0.96043911258621	6.97993951826093
F	-4.48934684922265	3.35882159157991	2.23492218756235
F	-4.78860438437537	2.25767004745821	4.66548955759109
H	-5.04989104033231	-0.46044591409402	10.23722556325534
O	-4.27039794974687	-0.05966389808977	9.80123159926582

F	-3.31177877682577	1.61320716676946	0.63506762408234
F	-2.31195200567523	1.11611610629574	8.64696817816373
F	-2.35350456324133	1.07297584895423	5.91169912138582
F	-2.87209136561495	1.15983241556094	3.27580662451077

90°CNTPFOS

C	-3.63234215329592	-3.34046561764376	2.40388439894439
C	-3.95248864331450	-2.03283100844904	2.17400154495424
C	-4.85283597671619	-1.33381360734420	3.06274026861155
C	-5.87730846165087	-0.46067340064835	2.58206009660934
C	-6.08248752741852	-0.22426101802258	1.17241031676912
C	-7.34675423404411	-0.18088437352192	0.65839350577670
C	-8.49039056223884	-0.37186013550967	1.51935124866922
C	-9.60754391862839	-1.17330964909010	1.12840035627059
C	-9.66372901891703	-1.83754764383856	-0.15261769602761
C	-10.12718783687765	-3.11861433615106	-0.24425417099346
C	-10.56563134863936	-3.82102273616029	0.93885256277974
C	-10.23297925090519	-5.19098062935517	1.17468190831197
C	-9.43509077606745	-5.95575794946633	0.24491443411726
C	-8.45573344288604	-6.79003378452866	0.70210065909702
C	-8.21037106255058	-6.91712317780537	2.11950046644401
C	-6.88744097332028	-6.96151811048668	2.65844443304586
C	-5.71018947353288	-6.88682705597646	1.82321745264672
C	-4.64261646787405	-6.12413848881484	2.20140006408760

C	-4.68576080147126	-5.37763265416325	3.43727794966225
C	-4.20104989566911	-4.03749882594377	3.53384174870985
C	-4.64712555006177	-3.23257512165570	4.62333324045197
C	-4.97533126950213	-1.85221476568145	4.38582648755450
C	-5.80204134574932	-1.17973641876859	5.33753519196957
C	-6.81717672972767	-0.31150465274492	4.86128149615847
C	-6.96696691849487	-0.14875732594063	3.44986930539288
C	-8.29985408639896	-0.10559061432594	2.90787293733477
C	-9.40113872822280	-0.23011721008717	3.80993493659958
C	-10.50834814390478	-1.02739072278349	3.42219335894043
C	-10.47567462722732	-1.66889807321050	2.14618307430883
C	-10.96416054919849	-3.01957149545124	2.04961671828481
C	-11.45528800979150	-3.64756031459908	3.23508354963022
C	-11.12727044963982	-5.00758590263353	3.46880879759039
C	-10.31803949686325	-5.68958776856469	2.50861808113184
C	-9.28765947183102	-6.57210799825311	2.99014397240507
C	-9.13192455651413	-6.72097306202475	4.40225093911352
C	-7.81893662675226	-6.76427783838845	4.93631120142185
C	-6.71115932906605	-6.65724155205513	4.04072197486636
C	-5.59031139118154	-5.84492630572914	4.43560076217254
C	-5.65059043889159	-5.18498223624508	5.69908591444881
C	-5.16908742476223	-3.85639743802204	5.79589326909134
C	-5.58897031069210	-3.04942290131839	6.90911504701296
C	-5.90847852578315	-1.69112264539437	6.67860056058293

C	-6.71771501247153	-0.99913357663773	7.63876815832344
C	-7.74174569614428	-0.12240107322600	7.15854881730446
C	-7.90739737610839	0.02106423664890	5.74106217806187
C	-9.21784821407060	0.06100618501518	5.20779138442587
C	-10.33363840308553	-0.04067682487275	6.10306892014484
C	-11.45028955642385	-0.84570998334716	5.71138742630245
C	-11.40085331541998	-1.51131139160312	4.44247282946226
C	-11.88033652167869	-2.83964477608566	4.34790048620054
C	-12.39929283574426	-3.47438635167669	5.52417452249237
C	-12.06828005261001	-4.84658786070110	5.76074280635647
C	-11.23374536422495	-5.52143416197871	4.80942571416537
C	-10.22255417858053	-6.39091001121551	5.28293736301173
C	-10.06778842137835	-6.56613101721873	6.69835227556286
C	-8.74298565536823	-6.61062724513791	7.23748711645171
C	-7.63738281038602	-6.47469213453850	6.33437593020315
C	-6.54162774076816	-5.67003146461238	6.71753212612967
C	-6.56833730392589	-5.02476526045421	7.99692862460228
C	-6.08262745525398	-3.68424605909459	8.09468800041281
C	-6.49332380718160	-2.88431409837899	9.19892275620978
C	-6.82007104819773	-1.51068491812881	8.96531187171936
C	-7.65551839996054	-0.83934554729073	9.91605816514590
C	-8.66907665922414	0.02759317396614	9.44155873579824
C	-8.82401159867720	0.20395711885172	8.02698632496166
C	-10.14918198943962	0.24658360664054	7.48707885498723

C	-11.25740757158689	0.11420742710577	8.38682073730222
C	-12.36202921036206	-0.68152469320194	7.99894669363967
C	-12.33484623067025	-1.32782294603936	6.71970464332447
C	-12.81954657239679	-2.67134882256988	6.62416202412515
C	-13.30899634385708	-3.30676334534218	7.81224919821809
C	-12.98001747178349	-4.66332535409481	8.04718160548714
C	-12.17074647171635	-5.35623427216906	7.08806677089665
C	-11.14714952610253	-6.23453786063554	7.56791880493361
C	-10.97891356032770	-6.37745251028594	8.98480200284491
C	-9.66813358917188	-6.42302026690599	9.51766589893932
C	-8.55455389223691	-6.32632005752637	8.62120395719247
C	-7.43764048960065	-5.51834021599635	9.01097581242776
C	-7.47665939988252	-4.85697628643302	10.28444731646617
C	-7.00622495392177	-3.52128570541326	10.37525937904413
C	-7.43063211188403	-2.71590226520941	11.48947862705241
C	-7.76233626106818	-1.35687602078290	11.25495820152814
C	-8.57280652966064	-0.67676351152701	12.21490494221481
C	-9.60310302787996	0.20576022278645	11.73315123411817
C	-9.76065241978541	0.35425791281018	10.32082162460324
C	-11.07332075148055	0.39928769553990	9.78575577188221
C	-12.18046896210033	0.29651010877647	10.68297572016745
C	-13.30504288074344	-0.51065200989984	10.28772131542151
C	-13.25294812550303	-1.16729970172873	9.01985850466770
C	-13.73264435617393	-2.49859702144245	8.92538692017254

C	-14.24659607452056	-3.12488202153915	10.10229258277173
C	-13.91013714720281	-4.50387752817365	10.34205433268441
C	-13.08218259320279	-5.17330272420289	9.38946376735647
C	-12.06674090732411	-6.04152879220149	9.86521208335940
C	-11.91542990379810	-6.20837329711761	11.27610857942125
C	-10.58240649656374	-6.25563701499430	11.81809141032786
C	-9.48126732416799	-6.13318281191658	10.91598633410481
C	-8.37104728240077	-5.34109546129192	11.30596533563243
C	-8.40348401872808	-4.69816662303401	12.58139010762151
C	-7.91831805925429	-3.34524723561621	12.67592750135262
C	-8.31810263753594	-2.54413201586892	13.78600859779916
C	-8.65574760754326	-1.17495005574521	13.54878248916858
C	-9.45320167721807	-0.41030203652199	14.47836469683896
C	-10.43166859528390	0.42551357356380	14.02109487638879
C	-10.67739634144013	0.55407093941856	12.60417121455260
C	-12.00075109275213	0.60174503651298	12.06475940959147
C	-13.17352527524453	0.52676909430048	12.90372229852024
C	-14.24070412785110	-0.23813456549391	12.52845744551844
C	-14.20592922806262	-0.97889976961504	11.28950833625372
C	-14.68889669681451	-2.32128394095350	11.19456335116927
C	-15.24140073867868	-3.01895716871036	12.33164240057073
C	-14.92140020253717	-4.32685870080417	12.55937225684837
C	-14.02837510758686	-5.02463569683915	11.66474932317863
C	-13.00389038893000	-5.89910131128396	12.14442066862595

C	-12.79830548170974	-6.13908079870416	13.55338782009023
C	-11.53408142926265	-6.18474186155964	14.06756868966137
C	-10.39064676793481	-5.99267121837508	13.20688853485199
C	-9.27219436758929	-5.19314149211696	13.59885323167885
C	-9.21610842286245	-4.52829570235766	14.87957121304065
C	-8.75429242136911	-3.24657510141251	14.96995449921388
H	-3.04283474330459	-3.89094123029349	1.66872900157567
H	-3.62303011985352	-1.55441798818960	1.24974673003407
H	-5.22681182540662	-0.21101408213355	0.49482372323171
H	-7.48428413147883	-0.13255671506960	-0.42333862662556
H	-9.21587074544959	-1.36519761689875	-1.02880368530730
H	-10.04349067677802	-3.65262741789492	-1.19252802301873
H	-9.52409605444613	-5.76993772739549	-0.82696129910023
H	-7.77474719065302	-7.25939097606466	-0.01025548509749
H	-5.72007052068850	-7.34113104102641	0.83067664411710
H	-3.80674954005335	-5.98403883089397	1.51412448826557
H	-9.36452165828096	-0.59626203167323	15.55020764992801
H	-11.11133663480413	0.89545345207622	14.73429591187771
H	-13.15838708630619	0.97514820653942	13.89878714838858
H	-15.06393998800229	-0.39049368801404	13.22881516850176
H	-15.81023381641854	-2.46756178176296	13.08251078762311
H	-15.23893598684854	-4.80257634540664	13.48904324421757
H	-13.65361330979093	-6.15494051938322	14.23134740435358
H	-11.39642176177185	-6.23641062170922	15.14911361832514

H	-9.66294854030302	-5.00078520991167	15.75618627659054
H	-8.83730779240867	-2.71222020058913	15.91807428933082
O	-1.76242198808028	-5.56844588211474	11.01007581102213
F	-0.82969968320868	-4.61557227046349	3.72114947176265
F	0.91611377209857	-4.58603878936492	1.63951392780768
F	-2.30764349911138	-4.83672400790473	5.94906010878458
F	-3.00867047702379	-4.26310252017048	8.46619956587418
F	1.67323524409910	-6.11142473647753	3.59219953650419
F	0.47448140906714	-5.26134034160236	5.86675289187715
F	-0.59347625443641	-5.19658924734949	8.22115672763624
F	2.52416689423788	-6.85866271171494	1.03832083480868
O	-4.17288374737153	-5.08125700026478	10.81823498619445
S	-2.96334938836005	-6.06791564546562	10.37845719908432
C	-0.67412828842716	-5.93623165461650	3.92855933811631
C	0.45232483902599	-5.84292763070554	1.59475947134383
C	-1.74245128688886	-6.01259413784928	6.29066476672026
C	-2.88556004992046	-5.58892931776036	8.55565013494843
C	0.49846767836707	-6.44729833337307	3.03462080324063
C	-0.42973798670294	-6.16495079242890	5.46093341143328
C	-1.57050703098641	-6.03194216141037	7.84795016537657
C	1.30212266929109	-6.63388487259071	0.55718628112284
F	1.40098362267285	-5.91066039543575	-0.55618936542116
H	-5.04254460246401	-5.49737070350614	10.64652927386110
F	-0.82208189865946	-5.82637606421890	1.14667456277681

F	-1.78939704913320	-6.57785881085057	3.54120112195863
F	-2.56314988158680	-7.02096239493544	5.95753447162088
F	-3.93878699831142	-6.18493817549067	7.97881824679061
F	0.41668017859907	-7.78694242310006	2.94994075033890
F	-1.25976577664132	-7.28245244303151	8.22954113872077
F	0.72300476573165	-7.79439037171720	0.26560516590311
F	0.05715471868109	-7.40290367405221	5.65809184358127
O	-3.41266343363927	-7.44712831962251	10.43738754074369

90^offCNTPFOA

C	-6.41805452180816	-3.42313508070976	0.30899542294276
C	-6.64309499028558	-2.07623896611043	0.20450130768215
C	-7.16620277573051	-1.33475420014401	1.32205469991068
C	-8.15644845915249	-0.32032787034054	1.17076242121028
C	-8.70115302225979	0.03561924382474	-0.11649823257898
C	-10.02531955852145	0.32999908182132	-0.25156693247817
C	-10.91918059870766	0.31077746671417	0.89103668341177
C	-12.25878762279087	-0.04701289040290	0.77714480801794
C	-12.80313801087616	-0.60855785264362	-0.44592187215623
C	-13.45263094049393	-1.80414518251540	-0.39387965100343
C	-13.52661342066997	-2.52278540829231	0.88027623671515
C	-13.24329341716535	-3.94110310431758	0.96615657311296
C	-12.83741908691951	-4.70229537368252	-0.17082363779609
C	-11.93570065307106	-5.73581655961736	-0.04239042816479

C	-11.38218104756551	-6.06764293043893	1.23175899637431
C	-9.99502810071399	-6.44704656719064	1.38130657025451
C	-9.10535296483206	-6.52943358455448	0.25896899830379
C	-7.83997731132187	-6.00626249776651	0.34251302861830
C	-7.40017106770812	-5.37351729277782	1.55368606459043
C	-6.71207499682389	-4.11073865624505	1.53757564401135
C	-6.74159032254529	-3.31804544085798	2.72208900071121
C	-6.96264431915481	-1.90892200862243	2.61577250614664
C	-7.40018214536083	-1.19810202475765	3.77712930959435
C	-8.38359465927208	-0.18098336674590	3.62968110215939
C	-8.91669963817878	0.07999158731238	2.31978473842218
C	-10.28216710889365	0.43779958920645	2.18352827949940
C	-11.09924716676591	0.48020913442322	3.36030437887777
C	-12.44565805411921	0.07833100693752	3.29869242962365
C	-13.14401927634783	-0.28706189496635	1.99125216598339
C	-13.52216526249468	-1.77492971857130	2.05304834204493
C	-13.65627141633351	-2.40351993695299	3.32898093934928
C	-13.41061976769810	-3.80639802016131	3.42376620769877
C	-13.00982301110208	-4.51465822832401	2.24833661755453
C	-12.07606628006572	-5.59549317116779	2.38303441423846
C	-11.58698028026461	-5.91745112064390	3.69085413717094
C	-10.21771007451569	-6.27657954783286	3.83652049064298
C	-9.39390324452743	-6.30237904372217	2.66277509319474
C	-8.06946501200983	-5.75655327807782	2.75196658510335

C	-7.65625829252369	-5.19696589894214	4.00389227466820
C	-6.97349614588702	-3.94923598608096	3.98907462842433
C	-6.95143393652385	-3.16673584385816	5.18358055955265
C	-7.17492693618873	-1.75572182655839	5.07482252345679
C	-7.59535324948270	-1.03520163295268	6.23390597364617
C	-8.57680747520308	-0.00864904468754	6.08631577934120
C	-9.09837092558555	0.25565334489545	4.78560350343421
C	-10.48490236686148	0.58019652886568	4.65271699510344
C	-11.30580722243857	0.64389962479741	5.82714685822423
C	-12.64925235487692	0.22294076065300	5.72677089835429
C	-13.09038721922293	-0.30016894915291	4.49609203442843
C	-13.72554334399549	-1.62587003271907	4.51768490181417
C	-13.86500598989686	-2.27092545328400	5.77762478866924
C	-13.63656262346662	-3.68255153503878	5.86810520186258
C	-13.23380746296562	-4.39992372867412	4.70596259951538
C	-12.30640060162027	-5.48106957426845	4.84534770442080
C	-11.81682297558036	-5.80492056602131	6.14706591277790
C	-10.43806663844891	-6.15450074763145	6.29227712479949
C	-9.61305647896557	-6.17363265578150	5.12685843079351
C	-8.29893616281729	-5.60912424769338	5.21340812905450
C	-7.87467241569606	-5.05251541483042	6.45833211678923
C	-7.18494258081927	-3.79919091639508	6.44136503110439
C	-7.17256097573162	-3.00916565190187	7.63523007508796
C	-7.37130946673496	-1.60082093320173	7.52827001813357

C	-7.80046335601416	-0.87891792731833	8.68522767222618
C	-8.77286531109904	0.14674298037148	8.54167630149555
C	-9.31551390525308	0.41998078212389	7.24166190466598
C	-10.68059336344396	0.77103241974857	7.11228736997969
C	-11.51001897705378	0.76647295970716	8.29344482875128
C	-12.84071859519177	0.34523684742146	8.23681270074407
C	-13.54345563805296	-0.02027580500641	6.93927208434099
C	-13.90560911887222	-1.50828554327289	6.98167472125243
C	-14.08699806054675	-2.13857338167243	8.21109226626147
C	-13.87175088550316	-3.55717372824575	8.31252067815250
C	-13.46382172006691	-4.27469272466895	7.15417262030523
C	-12.53824268522583	-5.35889787163820	7.29810931709805
C	-12.04540049553736	-5.66316369853578	8.59802088115279
C	-10.66251640157854	-5.99731446375187	8.74542910678855
C	-9.83332412917709	-6.02444948426448	7.58347504119651
C	-8.52100208988545	-5.46078259514350	7.66862455531570
C	-8.10445481130606	-4.89208684016071	8.91025459135759
C	-7.41476780191869	-3.64145419069843	8.89318413997871
C	-7.40056970455220	-2.85273045094615	10.08872161767749
C	-7.59151818394212	-1.45008807770141	9.98370849008957
C	-7.98146574165695	-0.72091446726683	11.15293472623700
C	-8.95103307885330	0.33072505398512	11.00901107542134
C	-9.48993968330642	0.58161975714584	9.70423493105034
C	-10.86681571524174	0.89017541741692	9.58255394044838

C	-11.65991718047640	0.93725536355490	10.77109003344542
C	-12.98531542636832	0.38904335782667	10.70623960300283
C	-13.44382508339521	-0.11519151628276	9.44832081830136
C	-14.11813207473925	-1.36768898266019	9.44404926317892
C	-14.35289859366001	-2.01879849283060	10.68623018208720
C	-14.14980082657998	-3.44839612854726	10.77574920967826
C	-13.69683938110365	-4.14341703546997	9.60171645597850
C	-12.76511245884866	-5.20499137154225	9.74744043714490
C	-12.28158826588173	-5.51351857498984	11.05965646872471
C	-10.88898486160086	-5.83632676345903	11.20964492093973
C	-10.06359155945332	-5.84642116582194	10.03694809293877
C	-8.76305579377300	-5.28290140882375	10.12052052968003
C	-8.34109165855496	-4.72854334566739	11.37374935892273
C	-7.63248068477549	-3.47776132618757	11.35736395881919
C	-7.56682791260632	-2.70266711932888	12.54757430533888
C	-7.73735204776900	-1.27360170614475	12.44182014272893
C	-8.10010461332174	-0.46479669474732	13.57064070222317
C	-9.02234783090774	0.54051195955586	13.43421239182030
C	-9.63978122721615	0.79864674777611	12.16296695253262
C	-11.03977671785174	1.10797867015684	12.04268036856386
C	-11.90884939723320	1.14617654850025	13.18723256147896
C	-13.16056592620971	0.59152830073641	13.12477497244999
C	-13.62425075667909	-0.02112682688390	11.90873551490514
C	-14.34788306701444	-1.26245531919592	11.89841061797874

C	-14.66393160914298	-1.96780554165938	13.11072678209083
C	-14.50977060368157	-3.32574253051864	13.18356637870895
C	-14.01022514485439	-4.05584167537836	12.04637254675747
C	-13.03299712904616	-5.11325014903379	12.19790646653191
C	-12.50254090498842	-5.47379808103337	13.47895898543135
C	-11.16853677175350	-5.77064827475698	13.62320760303122
C	-10.28820033509312	-5.73135570757212	12.49392359994366
C	-8.96460407743496	-5.15444759325106	12.57870264580871
C	-8.46020815246527	-4.59296247552920	13.79845765501726
C	-7.78081823916070	-3.40043149467702	13.78294899522373
H	-6.16061251859127	-3.99251049662261	-0.58602035196918
H	-6.55473133776712	-1.59675579719555	-0.77202521596199
H	-8.07736835170283	-0.04158144635721	-1.00911466786334
H	-10.43944385078746	0.48480439274931	-1.24962872519777
H	-12.59629840229411	-0.14589580364914	-1.41529954180448
H	-13.80577460802568	-2.28263353431149	-1.30898819102695
H	-13.12983004167217	-4.37849023716185	-1.17052806442418
H	-11.53494778596639	-6.19897786960608	-0.94547814601214
H	-9.47960576188243	-6.86301720692106	-0.71046867014596
H	-7.23403448210726	-5.93325586836878	-0.56247426583955
H	-7.75220852594089	-0.73585366924951	14.56905365121095
H	-9.38701710899368	1.05071096460302	14.32748462770539
H	-11.52403010199479	1.48124857345698	14.15205380932024
H	-13.74640399069392	0.49397842550416	14.04073377101323

H	-14.90151344458888	-1.40785172599874	14.01753039754270
H	-14.63498036127707	-3.82925142105844	14.14348666475489
H	-13.11927700168843	-5.36748617508828	14.37267108566238
H	-10.75927905064619	-5.88900292295025	14.62807973092619
H	-8.74654715712082	-5.02786940421656	14.75765015235391
H	-7.54057685280335	-2.91558635042972	14.73083888137474
C	-14.78285644086897	0.89196249317149	6.72212849024753
O	-14.75739453095980	2.09119784699181	6.83102038892580
O	-15.85264561512565	0.19575872181362	6.32187700152088
H	-16.54757958984511	0.82931566157272	6.06278973760054
C	-14.38853361027982	0.62282164282856	2.01856891127429
O	-15.44096942632895	0.24909894466596	2.53348632739701
O	-14.16847266252494	1.84127161574790	1.59444072123312
H	-14.90014712967293	2.44648184315116	1.89733218106170
F	-17.88409431915213	2.37792097368346	6.42845469554613
F	-20.23067569292507	2.68292299518660	7.64065657138777
F	-22.54792945162262	3.38096874806055	8.89031517133490
O	-15.94059195453488	3.39080525268536	2.87653945980539
F	-16.25951610446754	4.48807581317263	5.55922623840469
F	-18.01857565423800	4.60716527459073	7.71282297461115
F	-19.87990876838126	4.25590133464032	9.67021303340827
F	-21.96796105558896	4.11274250059238	11.37597387452368
C	-16.59583585868424	2.95451419289517	3.80081657422834
C	-18.35867820459273	3.41624072832535	5.70502371688977

C	-20.28311391834066	3.99570765920304	7.35738068514299
C	-22.13208661121602	4.64921244978932	9.06495025411833
F	-23.74319892078798	5.15173410266975	10.70397185782854
C	-17.23460838833102	3.97610676115585	4.78725485431834
C	-18.92343158892507	4.45295753643933	6.73166713953485
C	-20.62696104440680	4.76382339951587	8.67341195894235
C	-22.42584054000185	5.04235029363144	10.54273794535366
F	-19.35976056338249	2.98263675844234	4.91423266811574
F	-22.84745460377948	5.46344999021768	8.27301409559996
F	-21.25797749721236	4.21462269935980	6.45662332914625
H	-16.32584863535418	1.09251337710596	3.40108537022779
O	-16.82323616957628	1.70267359512674	4.07228423858751
F	-21.85675831646979	6.21232514589842	10.83384786850652
F	-17.76235610225095	4.96249394559563	4.03654032667554
F	-19.12559531983443	5.63528333665993	6.12870945501655
F	-20.33284575825996	6.06664541392073	8.52068236601304

90⁰ffCNTPFOS

C	-8.81069741835308	-1.79106226893307	-0.13153879740975
C	-9.18980358653455	-0.50168701391018	0.13373002736278
C	-9.37567983829823	-0.05987491725001	1.49079343336005
C	-10.45235802487334	0.79216186372386	1.87785362297590
C	-11.42799340505593	1.27422518567407	0.93190878895603
C	-12.74259298557709	1.36972506572937	1.28015056637150

C	-13.19524591558778	1.00608308163784	2.60946686664890
C	-14.45414774117379	0.45847998802591	2.83805522354688
C	-15.31384503903161	0.03099945548424	1.75017822883695
C	-15.78477877568830	-1.24729912675323	1.73919003726069
C	-15.35377216314990	-2.17653632441571	2.78503064759926
C	-14.92143515956585	-3.52350435222665	2.47084918597186
C	-14.84935364472673	-4.00252525598871	1.12866215969773
C	-13.86174759126169	-4.88376385348780	0.74626081079196
C	-12.88361019577271	-5.33539185371693	1.68359860400413
C	-11.49640000251067	-5.50362159207018	1.31127625154148
C	-11.03157792506127	-5.24482030068642	-0.02083831989685
C	-9.87057611763392	-4.54187706719577	-0.22128395413572
C	-9.11531850287009	-4.06253549298867	0.90122514488655
C	-8.60289053993164	-2.71891885537710	0.94715273972036
C	-8.31136307467740	-2.15815112300918	2.22475583238728
C	-8.69407837448058	-0.80761555289778	2.50032475568319
C	-8.78392314978661	-0.38964235726819	3.86520420293963
C	-9.85461504368595	0.46213285035175	4.25360514813907
C	-10.81852757401228	0.85714774953439	3.26313069259955
C	-12.17887577016210	1.00882725924915	3.63759615186836
C	-12.55560895448076	0.71268698393045	4.98852857842786
C	-13.80277770522475	0.11932954486523	5.26230036644884
C	-14.85281715810597	-0.13330413038557	4.18235802205857
C	-15.02691790666486	-1.65254399000316	4.03127953045868

C	-14.66429663056880	-2.50278084143745	5.11956633406311
C	-14.26691119524822	-3.84223572023923	4.82843778388361
C	-14.21716256620893	-4.26316162663289	3.46290860999304
C	-13.19315934530067	-5.18605461081170	3.06615610739067
C	-12.26490058976910	-5.64325250044250	4.05722583099626
C	-10.89818571125835	-5.79436472482463	3.69120073214282
C	-10.51762431246236	-5.48382191744285	2.34362381842936
C	-9.30131128804584	-4.75086473537052	2.13470294151431
C	-8.54944359808231	-4.35433264474893	3.28754996887079
C	-8.03947500862747	-3.02750425975454	3.33271139208734
C	-7.69433995951508	-2.46945904018546	4.60143413010080
C	-8.08050633373936	-1.11738782150618	4.87557853161050
C	-8.15516448850784	-0.68602304105074	6.23464536622989
C	-9.22619825305117	0.17478904896748	6.62423683415861
C	-10.17930129562692	0.56912006676280	5.63988312361989
C	-11.55467779744051	0.68265122528641	6.01639320951533
C	-11.93454301421957	0.40711266161044	7.37216843262951
C	-13.18903676670392	-0.20136564624980	7.60490160929336
C	-13.96387198569932	-0.56660092844609	6.48666608713633
C	-14.41476721845768	-1.96379737220481	6.41137390398969
C	-14.06534355201610	-2.83142649808242	7.48320762117476
C	-13.67648557144522	-4.17941457241110	7.19003613157588
C	-13.61583977340925	-4.61068274503030	5.83382810137820
C	-12.59464881312190	-5.53409678998604	5.44298033762263

C	-11.66787182058044	-5.99176223899179	6.42759908655029
C	-10.29320993849075	-6.13215296978371	6.06032685764320
C	-9.90894014892969	-5.81667172434022	4.72171466677174
C	-8.70452046787832	-5.06803431941943	4.51742506713144
C	-7.94372212503240	-4.67203259034737	5.65930709235320
C	-7.42685091960959	-3.33841748581456	5.70112064423428
C	-7.09206409460086	-2.77443667736087	6.97366920950246
C	-7.45368607441115	-1.42096090188332	7.24087586906996
C	-7.53714379884695	-0.98933437114257	8.60166393772147
C	-8.59775211108282	-0.12955832282993	8.99186071523326
C	-9.57082059884484	0.27025080367478	8.01517884611913
C	-10.92757375815784	0.40766183449526	8.39371319339810
C	-11.30374938445341	0.06016215069984	9.74377985471925
C	-12.52389611360441	-0.56000098454726	10.01020193553761
C	-13.58884637965838	-0.79403163443826	8.95385210974825
C	-13.78335277563991	-2.30685718970144	8.77943777558486
C	-13.47443692092325	-3.16248513715841	9.83615745952076
C	-13.09371623109404	-4.52095125594929	9.55457880637351
C	-13.02593485273544	-4.94866499246641	8.19970255023093
C	-12.00240090648524	-5.87412357233609	7.81254376702879
C	-11.07453779455016	-6.31230195770085	8.79838127590021
C	-9.69687171318914	-6.43645175710079	8.43568408606646
C	-9.30649574164218	-6.12836347757775	7.09735666587303
C	-8.10360324730785	-5.38164485711945	6.89204253078233

C	-7.35243333851560	-4.97471654879660	8.03623288668406
C	-6.83431845496142	-3.64476256878540	8.07709395411390
C	-6.49579278447569	-3.08226956768664	9.35035317247810
C	-6.84711476558980	-1.73283359176706	9.61555664323201
C	-6.89046886396059	-1.28998286073117	10.97666362546293
C	-7.95139139524254	-0.40392443998494	11.37176119347112
C	-8.92004423176087	-0.02511541365908	10.38526011233849
C	-10.28059428899789	0.06623785966047	10.76571038053978
C	-10.62884124181701	-0.22435966405579	12.12103867461438
C	-11.83781571819012	-0.96348058094804	12.35185719989864
C	-12.63952982306315	-1.31151617826309	11.22055691836748
C	-13.15826367781498	-2.63305123987661	11.15516680064784
C	-12.89843754149776	-3.51884864860340	12.23655907476767
C	-12.53844825054072	-4.88959300956434	11.94576383918032
C	-12.43818795592137	-5.28469863498097	10.56722076357578
C	-11.40944708715216	-6.18539638850734	10.18435829124502
C	-10.48551717961492	-6.63241442948723	11.18305526020882
C	-9.09841959370271	-6.74192977057288	10.82236266193497
C	-8.71730310487957	-6.41453172583178	9.47945027678142
C	-7.52572022562981	-5.66985311918606	9.27651973351568
C	-6.76370894555721	-5.27887499766621	10.42619486528798
C	-6.22604680275403	-3.94597563652225	10.46160549853558
C	-5.84015483605263	-3.38760447862083	11.71109727968700
C	-6.17434912799467	-2.00928059400967	11.97484518690191

C	-6.21403678637784	-1.47769693359885	13.30788808968718
C	-7.22373962711245	-0.63091880382065	13.68518933533892
C	-8.25574095647329	-0.26386370868505	12.75506031773875
C	-9.63761799775980	-0.17608511468552	13.14369453274706
C	-10.07088956700567	-0.48008971024226	14.48085179644225
C	-11.20988607485632	-1.21258095287136	14.69002771751204
C	-11.99323255605274	-1.67316087090033	13.57449914002406
C	-12.55650440344193	-2.99302300364876	13.52044960684709
C	-12.37838328710830	-3.93992991438392	14.58846754654582
C	-12.07848934001743	-5.24606958611863	14.31342186923480
C	-11.92004928899610	-5.67590787126145	12.94674889135618
C	-10.84756444581318	-6.56562084809650	12.55591663910636
C	-9.88448083534821	-7.04875009932075	13.50053483565349
C	-8.55692685740064	-7.14078687688339	13.15827424825368
C	-8.11498982185716	-6.76261428915224	11.84904932691602
C	-6.90303189657998	-6.00125177324034	11.64321408731296
C	-6.07506258318354	-5.58446512967942	12.73815525368972
C	-5.55842391990942	-4.31347484357059	12.77083242008555
H	-8.81611940978094	-2.14722901539755	-1.16334213346711
H	-9.48453031243501	0.14617129703665	-0.69373644662994
H	-11.13525887055777	1.45614109099344	-0.10398253682345
H	-13.48029652545059	1.62688344901119	0.51775841392306
H	-15.48912239432616	0.67956469653679	0.88696078201419
H	-16.37103350595364	-1.61337863211638	0.89464526810534

H	-15.48966422990216	-3.56313649125686	0.36270816195786
H	-13.74433917280841	-5.11359168506432	-0.31397009691143
H	-11.67435851022582	-5.46403398465157	-0.87520042251370
H	-9.61438515069667	-4.21542042575806	-1.23088535170630
H	-5.52449718620890	-1.85482218801887	14.06528096100689
H	-7.31540219520751	-0.34883448640798	14.73554982929631
H	-9.41944656260197	-0.25745143057023	15.32778324326152
H	-11.44229665378915	-1.56044793222742	15.69831319429509
H	-12.35271741924472	-3.59174536932893	15.62306099363546
H	-11.82651400494711	-5.92302616399780	15.13127300416010
H	-10.17326637817600	-7.20259613957054	14.54134759064904
H	-7.82456725209079	-7.36177723027740	13.93677661228195
H	-5.97890980385442	-6.21917818572330	13.62080566272542
H	-5.06140747483697	-3.96694047721721	13.67865495398110
C	-14.89499059025925	-0.05914516073827	9.36684465451607
O	-14.91990392444641	0.93747273076564	10.03898045654742
O	-15.97483010655301	-0.63377785975179	8.82211700549741
H	-16.74987953865141	-0.05279588791058	8.94391335597784
C	-16.12739193646685	0.51094359848877	4.75734720464816
O	-16.88548190945544	-0.13804821674471	5.48247882119911
O	-16.25843697791766	1.78433608818866	4.50551269580589
H	-17.02083927550859	2.17337317960936	5.01327514798606
O	-19.25795966120337	2.66729783067048	8.38390280118160
F	-23.35772260413961	1.65439798888444	6.41862400401396

F	-25.42407138261747	1.49060508083888	4.76296818476201
F	-21.15601569942017	0.73065495037469	7.40338531147839
F	-27.38734449137566	1.61577051004429	2.87767783591503
F	-21.29391420818187	3.43448939762809	6.27625226044591
F	-23.82143134044193	3.90885825375965	5.21626328134153
F	-26.44975892152302	3.85507171223076	4.49055740955748
F	-28.91990106326708	3.71969119186807	3.40673579055813
O	-18.07902627764073	0.68427621229478	7.48432645438055
S	-18.88237128483069	2.00052900112746	7.15973840101915
C	-20.43522089282924	1.23449944152433	6.40038489785238
C	-22.70215992163951	1.83601732361007	5.26175137733654
C	-24.83523252171008	2.26227068902001	3.83444464627163
C	-26.95371455296454	2.80829729130666	2.42901210895009
C	-21.24203016441702	2.28493339070979	5.57892542427081
C	-23.51614946761875	2.87147371614507	4.41690941424835
C	-25.85607694159769	3.35838747302642	3.39053133465010
C	-28.19245413967799	3.74236488912006	2.29429073343241
F	-28.94286861365900	3.31575662840379	1.28078550997488
H	-17.60301819179901	0.31248414776367	6.60766529538531
F	-22.64047911424598	0.66785897881011	4.59222612356263
F	-24.51324224633978	1.50601385639894	2.77010444819505
F	-20.04326534658710	0.24492739819529	5.58828934859931
F	-26.41829290569486	2.65490891138273	1.20769599953860
F	-20.58045333191355	2.48537885286161	4.42918700015708

F	-22.77649965365816	3.31165456100725	3.38737659418218
F	-25.20095316644542	4.34712346158270	2.75756823707855
F	-27.80377481388052	4.99365130047697	2.04799236994632
O	-18.22171805512340	2.72486801336914	6.0610609367246

REFERENCES

- [1] A. Manuel Stephan, *European Polymer Journal*, 42 (2006) 21-42.
- [2] W. Li, Y. Pang, J. Liu, G. Liu, Y. Wang, Y. Xia, *RSC Advances*, 7 (2017) 23494-23501.
- [3] H. Yu, J. Wu, L. Fan, Y. Lin, K. Xu, Z. Tang, C. Cheng, S. Tang, J. Lin, M. Huang, Z. Lan, *Journal of Power Sources*, 198 (2012) 402-407.
- [4] X. Peng, H. Liu, Q. Yin, J. Wu, P. Chen, G. Zhang, G. Liu, C. Wu, Y. Xie, *Nature Communications*, 7 (2016) 11782.
- [5] X. Tang, R. Muchakayala, S. Song, Z. Zhang, A.R. Polu, *Journal of Industrial and Engineering Chemistry*, 37 (2016) 67-74.
- [6] K. Yang, X. Ma, K. Sun, Y. Liu, F. Chen, *Journal of Solid State Electrochemistry*, 22 (2018) 441-452.
- [7] J.Y. Song, Y.Y. Wang, C.C. Wan, *Journal of Power Sources*, 77 (1999) 183-197.
- [8] Z. Zhang, C. Zuo, Z. Liu, Y. Yu, Y. Zuo, Y. Song, *Journal of Power Sources*, 251 (2014) 470-475.
- [9] D. Kumar, M. Suleman, S.A. Hashmi, *Solid State Ionics*, 202 (2011) 45-53.
- [10] A.A. Mohamad, *Journal of Power Sources*, 159 (2006) 752-757.
- [11] G.G. Kumar, S. Sampath, *Solid State Ionics*, 160 (2003) 289-300.
- [12] P.A. Hassan, G. Verma, R. Ganguly, 1 - Soft Materials — Properties and Applications, in: S. Banerjee, A.K. Tyagi (Eds.) *Functional Materials*, Elsevier, London, 2012, pp. 1-59
- [13] A.H. Karoyo, L.D. Wilson, *Gels*, 3 (2017) 1.
- [14] H. Lu, L. Yuan, X. Yu, C. Wu, D. He, J. Deng, *Burns & Trauma*, 6 (2018) 35.
- [15] W.H. Meyer, *Advanced Materials*, 8 (1996) 863-864.
- [16] C. Chen, R.A. Eichel, P.H.L. Notten, 16 - Ionic conductivity of metal oxides: An essential property for all-solid-state lithium-ion batteries, in: N. Pryds, V. Esposito (Eds.) *Metal Oxide-Based Thin Film Structures*, Elsevier, 2018, pp. 361-408.

- [17] N. Asthana, K. Pal, Chapter 14 - Polymerized hybrid nanocomposite implementations of energy conversion cells device, in: K. Pal, F. Gomes (Eds.) Nanofabrication for Smart Nanosensor Applications, Elsevier, 2020, pp. 349-397.
- [18] J.J. Fontanella, M.C. Wintersgill, J.P. Calame, C.G. Andeen, Solid State Ionics, 8 (1983) 333-339.
- [19] E.M.A. Dannoun, S.B. Aziz, M.A. Brza, M. M. Nofal, A.S.F.M. Asnawi, Y.M. Yusof, S. Al-Zangana, M.H. Hamsan, M.F.Z. Kadir, H.J. Woo, Polymers (Basel), 12 (2020) 2531.
- [20] G. Feuillade, P. Perche, Journal of Applied Electrochemistry, 5 (1975) 63-69.
- [21] J. Paul Sharma, V. Bharti, IOP Conference Series: Materials Science and Engineering, 961 (2020) 012005.
- [22] X.H. Flora, M. Ulaganathan, R.S. Babu, S. Rajendran, Ionics, 18 (2012) 731-736.
- [23] M. Kucharski, T. Łukaszewicz, P. Mrozek, Opto - Electronics Review, Vol. 12, No. 2 (2004) 175-180.
- [24] K. Zaghib, P. Charest, A. Guerfi, J. Shim, M. Perrier, K. Striebel, Journal of Power Sources, 134 (2004) 124-129.
- [25] M. Deka, A. Kumar, Bulletin of Materials Science, 32 (2009) 627-632.
- [26] P. Vickraman, V. Aravindan, M. Selvambikai, N. Shankarasubramanian, Ionics, 15 (2009) 433-437.
- [27] C.S. Kim, S.M. Oh, Electrochimica Acta, 45 (2000) 2101-2109.
- [28] Y. Ito, K. Kanehori, K. Miyauchi, T. Kudo, Journal of Materials Science, 22 (1987) 1845-1849.
- [29] K.M. Abraham, M. Alamgir, Journal of The Electrochemical Society, 137 (1990) 1657-1658.
- [30] Q. Wang, H. Wang, J. Wu, M. Zhou, W. Liu, H. Zhou, Nano Energy, 80 (2021) 105516.
- [31] M. Deka, A. Kumar, Electrochimica Acta, 55 (2010) 1836-1842.

- [32] S. Ahmad, H.B. Bohidar, S. Ahmad, S.A. Agnihotry, *Polymer*, 47 (2006) 3583-3590.
- [33] X.-L. Wang, A. Mei, M. Li, Y.-H. Lin, C.-W. Nan, *Journal of Applied Physics*, 102 (2007) 054907.
- [34] A. Arya, A.L. Sharma, *Ionics*, 23 (2017) 497-540.
- [35] D.-W. Kim, Y.-R. Kim, J.-K. Park, S.-I. Moon, *Solid State Ionics*, 106 (1998) 329-337.
- [36] B. Oh, Y.R. Kim, *Solid State Ionics*, 124 (1999) 83-89.
- [37] Q. Li, T. Itoh, N. Imanishi, A. Hirano, Y. Takeda, O. Yamamoto, *Solid State Ionics*, 159 (2003) 97-109.
- [38] S. Agnihotri, S. Mukherji, S. Mukherji, *Applied Nanoscience*, 2 (2012) 179-188.
- [39] R.K. Nagarale, V.K. Shahi, R. Rangarajan, *Journal of Membrane Science*, 248 (2005) 37-44.
- [40] M.B. Bryning, D.E. Milkie, M.F. Islam, L.A. Hough, J.M. Kikkawa, A.G. Yodh, *Advanced Materials*, 19 (2007) 661-664.
- [41] A.F. Al Yaqout, *Waste Management*, 23 (2003) 817-824.
- [42] F.-H. Kuok, H.-H. Chien, C.-C. Lee, Y.-C. Hao, I.-S. Yu, C.-C. Hsu, I.C. Cheng, J.-Z. Chen, *RSC Advances*, 8 (2018) 2851-2857.
- [43] L. Sun, X. Wang, Y. Wang, Q. Zhang, *Carbon*, 122 (2017) 462-474.
- [44] C.M. Hussain, C. Saridara, S. Mitra, *Analyst*, 134 (2009) 1928-1933.
- [45] W. Intrchom, S. Roy, S. Mitra, *Separation and Purification Technology*, 235 (2020) 116188.
- [46] M. Bhadra, S. Roy, S. Mitra, *Separation and Purification Technology*, 120 (2013) 373-377.
- [47] M. Bhadra, S. Roy, S. Mitra, *ACS Applied Materials & Interfaces*, 8 (2016) 19507-19513.
- [48] S. Roy, M. Bhadra, S. Mitra, *Separation and Purification Technology*, 136 (2014) 58-65.

- [49] A. Peigney, C. Laurent, E. Flahaut, R.R. Bacsa, A. Rousset, *Carbon*, 39 (2001) 507-514.
- [50] M.M.-A. Aslam, H.-W. Kuo, W. Den, M. Usman, M. Sultan, H. Ashraf, *Sustainability*, 13 (2021) 5717.
- [51] T. Zhang, S. Mubeen, N.V. Myung, M.A. Deshusses, *Nanotechnology*, 19 (2008) 332001.
- [52] R. Khorram, H. Raissi, A. Morsali, *Journal of Molecular Liquids*, 240 (2017) 87-97.
- [53] M. Garzia Trulli, E. Sardella, F. Palumbo, G. Palazzo, L.C. Giannossa, A. Mangone, R. Comparelli, S. Musso, P. Favia, *Journal of Colloid and Interface Science*, 491 (2017) 255-264.
- [54] M. Kwiatkowska, R. Pełech, A. Jędrzejewska, D. Moszyński, I. Pełech, *Polymers (Basel)*, 12 (2020) 308.
- [55] M. Mananghaya, M.A. Promentilla, K. Aviso, R. Tan, *Journal of Molecular Liquids*, 215 (2016) 780-786.
- [56] M. Sianipar, S.H. Kim, Khoiruddin, F. Iskandar, I.G. Wenten, *RSC Advances*, 7 (2017) 51175-51198.
- [57] P.-C. Ma, N.A. Siddiqui, G. Marom, J.-K. Kim, *Composites Part A: Applied Science and Manufacturing*, 41 (2010) 1345-1367.
- [58] Z. Wu, Z. Wang, F. Yu, M. Thakkar, S. Mitra, *J Nanopart Res*, 19 (2017).
- [59] W. Huang, Y. Lin, S. Taylor, J. Gaillard, A.M. Rao, Y.-P. Sun, *Nano Letters*, 2 (2002) 231-234.
- [60] J.-H. Choi, J. Jegal, W.-N. Kim, *Journal of Membrane Science*, 284 (2006) 406-415.
- [61] I.-Y. Jeon, D. Chang, A.K. Nanjundan, J.-B. Baek, *Functionalization of Carbon Nanotubes*, in, 2011.
- [62] Y. Wang, Z. Iqbal, S. Mitra, *Journal of the American Chemical Society*, 128 (2006) 95-99.
- [63] A. Shaabani, A. Bazgir, *Tetrahedron Letters*, 45 (2004) 2575-2577.
- [64] M. Ardon, G. Hogarth, D.T.W. Oscroft, *Journal of Organometallic Chemistry*, 689 (2004) 2429-2435.

- [65] D.A. Lewis, J.D. Summers, T.C. Ward, J.E. McGrath, *Journal of Polymer Science Part A: Polymer Chemistry*, 30 (1992) 1647-1653.
- [66] Z. Wang, Z. Wu, G. Di Benedetto, J.L. Zunino, S. Mitra, *Carbon*, 91 (2015) 103-113.
- [67] S.I.A. Halim, C.H. Chan, J. Apotheker, *Chemistry Teacher International*, 3 (2021) 105-115.
- [68] K.S. Cole, R.H. Cole, *The Journal of Chemical Physics*, 9 (1941) 341-351.
- [69] S. Zhu, F. Ma, Y. Wang, W. Yan, D. Sun, Y. Jin, *Journal of Materials Science*, 52 (2017).
- [70] L. Tan, Y. Deng, Q. Cao, B. Jing, X. Wang, Y. Liu, *Ionics*, 25 (2019) 3673-3682.
- [71] M.-J. Lee, S. Lee, V. Roev, D. Im, W. Choi, M.-S. Kang, *Ionics*, 26 (2020) 4795-4802.
- [72] A. Méry, S. Rousselot, D. Lepage, M. Dollé, *Materials*, 14 (2021) 3840.
- [73] O. Gupta, S. Roy, S. Mitra, *Journal of Membrane Science*, 568 (2018) 134-140.
- [74] M. Kokate, K. Garadkar, A. Gole, *Journal of Materials Chemistry A*, 1 (2013) 2022-2029.
- [75] A. Farrukh, A. Akram, A. Ghaffar, S. Hanif, A. Hamid, H. Duran, B. Yameen, *ACS Applied Materials & Interfaces*, 5 (2013) 3784-3793.
- [76] C.L. Yang, Z.H. Li, W.J. Li, H.Y. Liu, Q.Z. Xiao, G.T. Lei, Y.H. Ding, *Journal of Membrane Science*, 495 (2015) 341-350.
- [77] D.A. Britz, A.N. Khlobystov, *Chemical Society Reviews*, 35 (2006) 637-659.
- [78] Q. Yang, L. Li, H. Cheng, M. Wang, J. Bai, *Chinese Science Bulletin*, 48 (2003) 2395-2403.
- [79] W. Guo, H.H. Ngo, J. Li, *Bioresour Technol*, 122 (2012) 27-34.
- [80] I. Jurewicz, J.L. Keddie, A.B. Dalton, *Langmuir*, 28 (2012) 8266-8274.
- [81] S.B. Darling, *Journal of Applied Physics*, 124 (2018) 030901.

- [82] A.J.R. Hensley, K. Ghale, C. Rieg, T. Dang, E. Anderst, F. Studt, C.T. Campbell, J.-S. McEwen, Y. Xu, *The Journal of Physical Chemistry C*, 121 (2017) 4937-4945.
- [83] Y.S. Meng, M.E. Arroyo-de Dompablo, *Energy & Environmental Science*, 2 (2009) 589-609.
- [84] A.A. Alex, 4.16 - Quantum Mechanical Calculations in Medicinal Chemistry: Relevant Method or a Quantum Leap Too Far?, in: J.B. Taylor, D.J. Triggle (Eds.) *Comprehensive Medicinal Chemistry II*, Elsevier, Oxford, 2007, pp. 379-420.
- [85] S. Fournais, M. Hoffmann-Ostenhof, T. Hoffmann-Ostenhof, T.Ø. Sørensen, *Communications in Mathematical Physics*, 255 (2005) 183-227.
- [86] J.M. Hutson, *Computer Physics Communications*, 84 (1994) 1-18.
- [87] D.M. Hanson, E. Harvey, R. Sweeney, T.J. Zielinski, in, 2020.
- [88] K.A. Baseden, J.W. Tye, *Journal of Chemical Education*, 91 (2014) 2116-2123.
- [89] C. Leforestier, R.H. Bisseling, C. Cerjan, M.D. Feit, R. Friesner, A. Guldberg, A. Hammerich, G. Jolicard, W. Karrlein, H.D. Meyer, N. Lipkin, O. Roncero, R. Kosloff, *Journal of Computational Physics*, 94 (1991) 59-80.
- [90] S.J. Klippenstein, C. Cavallotti, Chapter 2 - Ab initio kinetics for pyrolysis and combustion systems, in: T. Faravelli, F. Manenti, E. Ranzi (Eds.) *Computer Aided Chemical Engineering*, Elsevier, 2019, pp. 115-167.
- [91] M. Lusk, A. Mattsson, *MRS Bulletin*, 36 (2011).
- [92] J. Sun, J.W. Furness, Y. Zhang, Chapter 4 - Density functional theory, in: S.M. Blinder, J.E. House (Eds.) *Mathematical Physics in Theoretical Chemistry*, Elsevier, 2019, pp. 119-159.
- [93] C.C.M. Rindt, S.V. Gaastra-Nedeja, 15 - Modeling thermochemical reactions in thermal energy storage systems, in: L.F. Cabeza (Ed.) *Advances in Thermal Energy Storage Systems*, Woodhead Publishing, 2015, pp. 375-415.
- [94] W. Kohn, L.J. Sham, *Physical Review*, 140 (1965) A1133-A1138.
- [95] J. Antony, S. Grimme, *Physical Chemistry Chemical Physics*, 8 (2006) 5287-5293.

- [96] C. Lee, W. Yang, R.G. Parr, *Physical Review B*, 37 (1988) 785-789.
- [97] S.-H. Wang, P.-L. Kuo, C.-T. Hsieh, H. Teng, *ACS Applied Materials & Interfaces*, 6 (2014) 19360-19370.
- [98] M.A.K.L. Dissanayake, L.R.A.K. Bandara, R.S.P. Bokalawala, P.A.R.D. Jayathilaka, O.A. Ileperuma, S. Somasundaram, *Materials Research Bulletin*, 37 (2002) 867-874.
- [99] H. Yu, J. Wu, L. Fan, K. Xu, X. Zhong, Y. Lin, J. Lin, *Electrochimica Acta*, 56 (2011) 6881-6886.
- [100] G. Wang, X. Lu, Y. Ling, T. Zhai, H. Wang, Y. Tong, Y. Li, *ACS Nano*, 6 (2012) 10296-10302.
- [101] S. ÇAvuŞ, E. Durgun, in, pp. 621-624.
- [102] M. Mokhtar, E.H. Majlan, M.Z.M. Talib, A. Ahmad, S.M. Tasirin, W.R.W. Daud, *Int. J. Appl. Eng. Res.* ISSN, 11 (2016) 973-4562.
- [103] C.-C. Yang, S.-J. Lin, *Journal of Power Sources*, 112 (2002) 497-503.
- [104] R. Sharma, A. Sil, S. Ray, *Polymer Composites*, 37 (2016) 1936-1944.
- [105] J.-H. Cao, B.-K. Zhu, Y.-Y. Xu, *Journal of Membrane Science*, 281 (2006) 446-453.
- [106] X. Liu, Y. Liang, G. Yue, Y. Tu, H. Zheng, *Solar Energy*, 148 (2017) 63-69.
- [107] P. Wang, S.M. Zakeeruddin, J.E. Moser, M.K. Nazeeruddin, T. Sekiguchi, M. Grätzel, *Nature Materials*, 2 (2003) 402-407.
- [108] P. Wang, S.M. Zakeeruddin, I. Exnar, M. Grätzel, *Chemical Communications*, (2002) 2972-2973.
- [109] J.H. Wu, Z. Lan, J.M. Lin, M.L. Huang, S.C. Hao, T. Sato, S. Yin, *Advanced Materials*, 19 (2007) 4006-4011.
- [110] Shalu, V.K. Singh, R.K. Singh, *Journal of Materials Chemistry C*, 3 (2015) 7305-7318.
- [111] J. Zhang, B. Sun, X. Huang, S. Chen, G. Wang, *Scientific Reports*, 4 (2014) 6007.

- [112] G. Ma, E. Feng, K. Sun, H. Peng, J. Li, Z. Lei, *Electrochimica Acta*, 135 (2014) 461-466.
- [113] X. Yang, F. Zhang, L. Zhang, T. Zhang, Y. Huang, Y. Chen, *Advanced Functional Materials*, 23 (2013) 3353-3360.
- [114] S.S. Sekhon, *Bulletin of Materials Science*, 26 (2003) 321-328.
- [115] Q. Li, J. Chen, L. Fan, X. Kong, Y. Lu, *Green Energy & Environment*, 1 (2016) 18-42.
- [116] S.H. Chung, Y. Wang, L. Persi, F. Croce, S.G. Greenbaum, B. Scrosati, E. Plichta, *Journal of Power Sources*, 97-98 (2001) 644-648.
- [117] H.-S. Kim, K.-S. Kum, W.-I. Cho, B.-W. Cho, H.-W. Rhee, *Journal of Power Sources*, 124 (2003) 221-224.
- [118] S. Sun, P. Wu, *Journal of Materials Chemistry*, 21 (2011) 4095-4097.
- [119] Q. Pan, N. Tong, N. He, Y. Liu, E. Shim, B. Pourdeyhimi, W. Gao, *ACS Applied Materials & Interfaces*, 10 (2018) 7927-7934.
- [120] O.S. Asiq Rahman, M. Sribalaji, B. Mukherjee, T. Laha, A.K. Keshri, *Ceramics International*, 44 (2018) 2109-2122.
- [121] H. Liu, G. Zhang, H. Li, *AIP Conference Proceedings*, 1820 (2017) 030009.
- [122] J.-H. Chang, *Nanomaterials*, 9 (2019) 323.
- [123] S. Azizighannad, S. Mitra, *Journal of Nanoparticle Research*, 22 (2020) 130.
- [124] S.G. Rathod, R.F. Bhajantri, V. Ravindrachary, J. Naik, D.J.M. Kumar, *RSC Advances*, 6 (2016) 77977-77986.
- [125] P. Hu, T. Wang, J. Zhao, C. Zhang, J. Ma, H. Du, X. Wang, G. Cui, *ACS Applied Materials & Interfaces*, 7 (2015) 26396-26399.
- [126] Z. Wu, Z. Wang, F. Yu, M. Thakkar, S. Mitra, *Journal of Nanoparticle Research*, 19 (2017) 16.
- [127] Z. Wu, R.F. Hamilton, Z. Wang, A. Holian, S. Mitra, *Carbon*, 68 (2014) 678-686.
- [128] E. Frackowiak, K. Metenier, V. Bertagna, F. Beguin, *Applied Physics Letters*, 77 (2000) 2421-2423.

- [129] W.-H. Pan, S.J. Lue, C.-M. Chang, Y.-L. Liu, *Journal of Membrane Science*, 376 (2011) 225-232.
- [130] C.-C. Yang, S.-J. Lin, *Materials Letters*, 57 (2002) 873-881.
- [131] Y.P. S. Bhavani, M. Ravi, K. Kiran Kumar, V.V.R. Narasimha Rao., *Int. J. Electrochem. Sci*, 8.
- [132] N.-T. Nguyen, J.-H. Liu, *European Polymer Journal*, 49 (2013) 4201-4211.
- [133] J. Liu, W. Wang, A. Wang, *Polymers for Advanced Technologies*, 22 (2011) 627-634.
- [134] E.Y. Malikov, M.B. Muradov, O.H. Akperov, G.M. Eyvazova, R. Puskás, D. Madarász, L. Nagy, Á. Kukovecz, Z. Kónya, *Physica E: Low-dimensional Systems and Nanostructures*, 61 (2014) 129-134.
- [135] J.M. Gohil, A. Bhattacharya, P. Ray, *Journal of Polymer Research*, 13 (2006) 161-169.
- [136] Z. Çiplak, N. Yildiz, A. Çalimli, *Investigation of Graphene/Ag Nanocomposites Synthesis Parameters for Two Different Synthesis Methods*, 2014.
- [137] H.S. Mansur, C.M. Sadahira, A.N. Souza, A.A.P. Mansur, *Materials Science and Engineering: C*, 28 (2008) 539-548.
- [138] C.W. Bunn, *Nature*, 161 (1948) 929.
- [139] A.A. Mohamad, A.K. Arof, *Ionics*, 12 (2006) 57-61.
- [140] M.A. Vargas, R.A. Vargas, B.E. Mellander, *Electrochimica Acta*, 45 (2000) 1399-1403.
- [141] A.L. Saroj, R.K. Singh, *Journal of Physics and Chemistry of Solids*, 73 (2012) 162-168.
- [142] K.S. Hun, C.J. Kuk, B.Y. Chan, *Journal of Applied Polymer Science*, 81 (2001) 948-956.
- [143] D. Saikia, A. Kumar, *Electrochimica Acta*, 49 (2004) 2581-2589.
- [144] G.P. Pandey, S.A. Hashmi, *Journal of Power Sources*, 187 (2009) 627-634.

- [145] R. S Diana Sangeetha, T. Arasu, G. Hirankumar, R. S Daries Bella, ANALYSIS OF DIELECTRIC, MODULUS, ELECTRO CHEMICAL STABILITY OF PVP – ABSA POLYMER ELECTROLYTE SYSTEMS, 2016.
- [146] M. Jiang, J. Zhu, C. Chen, Y. Lu, Y. Ge, X. Zhang, ACS Applied Materials & Interfaces, 8 (2016) 3473-3481.
- [147] M. Deka, A. Kumar, P. Chutia, Ionics, 19 (2013) 1367-1374.
- [148] M. Armand, J.M. Tarascon, Nature, 451 (2008) 652.
- [149] X. Zhu, H. Yang, Y. Cao, X. Ai, Electrochimica Acta, 49 (2004) 2533-2539.
- [150] W.H. Meyer, Advanced Materials, 10 (1998) 439-448.
- [151] F. Baskoro, H.Q. Wong, H.-J. Yen, ACS Applied Energy Materials, 2 (2019) 3937-3971.
- [152] J.P. Sharma, V. Bharti, in, 2020, pp. 012005.
- [153] M. Marcinek, J. Syzdek, M. Marczewski, M. Piszcz, L. Niedzicki, M. Kalita, A. Plewa-Marczewska, A. Bitner, P. Wieczorek, T. Trzeciak, M. Kasprzyk, P.Łęzak, Z. Zukowska, A. Zalewska, W. Wieczorek, Solid State Ionics, 276 (2015) 107-126.
- [154] E.S. Karaman, Z. Wang, K. Chen, Z. Siddiqui, Y. Cheng, S. Basuray, V. Kumar, S. Mitra, Materials Chemistry and Physics, 264 (2021) 124448.
- [155] P. Hohenberg, W. Kohn, Physical Review, 136 (1964) B864-B871.
- [156] F. Neese, F. Wennmohs, U. Becker, C. Riplinger, The Journal of Chemical Physics, 152 (2020) 224108.
- [157] A. Schäfer, C. Huber, R. Ahlrichs, The Journal of Chemical Physics, 100 (1994) 5829-5835.
- [158] M. Darvish Ganji, H. Kiyani, Scientific Reports, 9 (2019) 10605.
- [159] A.D. Becke, E.R. Johnson, The Journal of Chemical Physics, 123 (2005) 154101.
- [160] K. Eichkorn, F. Weigend, O. Treutler, R. Ahlrichs, Theoretical Chemistry Accounts, 97 (1997) 119-124.
- [161] T.Y. Nikolaienko, L.A. Bulavin, D.M. Hovorun, Computational and Theoretical Chemistry, 1050 (2014) 15-22.

- [162] Y.-P. Sun, K. Fu, Y. Lin, W. Huang, *Accounts of Chemical Research*, 35 (2002) 1096-1104.
- [163] P. Johansson, J. Tegenfeldt, J. Lindgren, *Polymer*, 40 (1999) 4399-4406.
- [164] A. Eatemadi, H. Daraee, H. Karimkhanloo, M. Kouhi, N. Zarghami, A. Akbarzadeh, M. Abasi, Y. Hanifehpour, S.W. Joo, *Nanoscale Research Letters*, 9 (2014) 393.
- [165] Z. Wu, Z. Wang, F. Yu, M. Thakkar, S. Mitra, *J Nanopart Res*, 19 (2017) 16.
- [166] M. Yoosefian, H. Raissi, A. Mola, *Sensors and Actuators B: Chemical*, 212 (2015) 55-62.
- [167] N. Saifuddin, A.Z. Raziah, A.R. Junizah, *Journal of Chemistry*, 2013 (2013) 676815.
- [168] H. Li, X.-T. Ma, J.-L. Shi, Z.-K. Yao, B.-K. Zhu, L.-P. Zhu, *Electrochimica Acta*, 56 (2011) 2641-2647.
- [169] L.-Q. Fan, Q.-M. Tu, C.-L. Geng, J.-L. Huang, Y. Gu, J.-M. Lin, Y.-F. Huang, J.-H. Wu, *Electrochimica Acta*, 331 (2020) 135425.
- [170] M. Elimelech, *Journal of Water Supply: Research and Technology-Aqua*, 55 (2006) 3-10.
- [171] M. Jaishankar, T. Tseten, N. Anbalagan, B.B. Mathew, K.N. Beeregowda, *Interdiscip Toxicol*, 7 (2014) 60-72.
- [172] S. Sharma, A. Bhattacharya, *Applied Water Science*, 7 (2017) 1043-1067.
- [173] J. Qu, *Journal of Environmental Sciences*, 20 (2008) 1-13.
- [174] S.D. Alexandratos, *Industrial & Engineering Chemistry Research*, 48 (2009) 388-398.
- [175] C. Charcosset, *Desalination*, 245 (2009) 214-231.
- [176] T.A. Saleh, V.K. Gupta, Chapter 1 - An Overview of Membrane Science and Technology, in: T.A. Saleh, V.K. Gupta (Eds.) *Nanomaterial and Polymer Membranes*, Elsevier, 2016, pp. 1-23.
- [177] E. Obotey Ezugbe, S. Rathilal, *Membranes*, 10 (2020) 89.
- [178] S.S. Madaeni, *Water Research*, 33 (1999) 301-308.

- [179] R. Rautenbach, *Chemie Ingenieur Technik*, 68 (1996) 168-169.
- [180] M.A. Atieh, O.Y. Bakather, B. Tawabini, B. Al-Tawbini, A.A. Bukhari, F.A. Abuilawi, M.B. Fettouhi, *Bioinorg Chem Appl*, 2010 (2010) 603978-603978.
- [181] V. Santosh, V. Polisetti, G. Jonnalagadda, N. Rao, V. Sainath, R. Avreddy, *Bulletin of Materials Science*, 43 (2020).
- [182] M. Usman Farid, H.-Y. Luan, Y. Wang, H. Huang, A.K. An, R. Jalil Khan, *Chemical Engineering Journal*, 325 (2017) 239-248.
- [183] M.A. Atieh, O.Y. Bakather, B. Tawabini, B. Al-Tawbini, A.A. Bukhari, F.A. Abuilawi, M.B. Fettouhi, *Bioinorg Chem Appl*, 2010 (2010) 603978.
- [184] C. Rodríguez, S. Briano, E. Leiva, *Molecules*, 25 (2020) 3106.
- [185] W. Intrchom, S. Roy, S. Mitra, *Nanomaterials*, 10 (2020) 578.
- [186] V. Schroeder, S. Savagatrup, M. He, S. Lin, T.M. Swager, *Chem Rev*, 119 (2019) 599-663.
- [187] B. Ye, S.-I. Kim, M. Lee, M. Ezazi, H.-D. Kim, G. Kwon, D.H. Lee, *RSC Advances*, 10 (2020) 16700-16708.
- [188] M. Ghalkhani, J. Beheshtian, M. Salehi, *Materials Science and Engineering: C*, 69 (2016) 1345-1353.