

Copyright Warning & Restrictions

The copyright law of the United States (Title 17, United States Code) governs the making of photocopies or other reproductions of copyrighted material.

Under certain conditions specified in the law, libraries and archives are authorized to furnish a photocopy or other reproduction. One of these specified conditions is that the photocopy or reproduction is not to be “used for any purpose other than private study, scholarship, or research.” If a user makes a request for, or later uses, a photocopy or reproduction for purposes in excess of “fair use” that user may be liable for copyright infringement,

This institution reserves the right to refuse to accept a copying order if, in its judgment, fulfillment of the order would involve violation of copyright law.

Please Note: The author retains the copyright while the New Jersey Institute of Technology reserves the right to distribute this thesis or dissertation

Printing note: If you do not wish to print this page, then select “Pages from: first page # to: last page #” on the print dialog screen

The Van Houten library has removed some of the personal information and all signatures from the approval page and biographical sketches of theses and dissertations in order to protect the identity of NJIT graduates and faculty.

ABSTRACT

DEVELOPMENT OF ICEJET MACHINING TECHNOLOGY

by
Dmitri V. Shishkin

This work was concerned with the application of ice powder for material processing. Material cutting and surface cleaning were also studied. As a result, innovative cleaning and etching technology was pioneered. The corresponding technology was designed and demonstrated.

The study involved investigation of water freezing, crushing of generated ice, ice transportation, formation of ice water and ice air streams and, finally, use of this stream for material cutting and cleaning. The theoretical work included investigation of the phase change in water and ice formation, effect of ice temperature on particles behavior and entrainment of ice particles by the water stream. Finite element modeling was used for investigation of particle entrainment process. The theoretical study was based on the examination of available information about ice behavior.

The experimental study of the second mode of icejet formation involved design and construction of apparatus for generation of ice powder, formation of ice water and ice air streams and the use of these streams for cutting and cleaning. Six different devices for powder production were tested and an acceptable devise design was selected. A conventional nozzle head was used for formation of abrasive water jet in our experiment. Ice powder was supplied as the conventional abrasive materials. The obtained jet was used for cutting various metal samples. The feasibility of cutting steel, titanium, and other materials using ice as abrasive was demonstrated. However process

productivity was low. Finite element analysis showed that only small portion of ice particles survive in the course of jet formation and in order to enhance process productivity it is necessary to prevent melting of the particles.

Conventional gun for sand blasting was used for formation of ice air jet. The generated jet was used for various cleaning and decoating operations. The experiments involved removal of heavy conductive grease from an electronic board, emulsion from a photo film, and paint from CD-ROM, etc.

The performed study demonstrated the feasibility of the use of the water ice as an abrasive material. Thus, such environmentally hostile technology as sand blasting can be replaced by green ice based processing. The feasibility of the use of ice as a machining tool and thus, formation of green machining technology was demonstrated.

**DEVELOPMENT OF ICEJET
MACHINING TECHNOLOGY**

**by
Dmitri V. Shishkin**

**A Thesis
Submitted to the Faculty of
New Jersey Institute of Technology
in Partial Fulfillment of the Requirements for the Degree of
Master of Science in the Mechanical Engineering**

Department of Mechanical Engineering

May 1999

APPROVAL PAGE

**DEVELOPMENT OF ICEJET
MACHINING TECHNOLOGY**

Dmitri V. Shishkin

Dr. Ernest S. Geskin, Thesis Adviser Date
Professor of Mechanical Engineering
Department of Mechanical Engineering
New Jersey Institute of Technology, Newark, NJ

Dr. Zhiming Ji, Committee Member Date
Associate Professor of Mechanical Engineering
Department of Mechanical Engineering
New Jersey Institute of Technology, Newark, NJ

Dr. Raj Sodhi, Committee Member Date
Associate Professor of Mechanical Engineering
Department of Mechanical Engineering
New Jersey Institute of Technology, Newark, NJ

BIOGRAPHICAL SCETCH

Author: Dmitri V. Shishkin
Degree: Master of Science in Mechanical Engineering
Date: May 1999

Undergraduate and Graduate Education:

- Master of Science in Mechanical Engineering
New Jersey Institute of Technology, Newark, NJ, 1999
- Master of Science in Electrical Engineering
Krivoy Rog Technical University, Ukraine, 1995
- Bachelor of Science in Electrical Engineering
Krivoy Rog Technical University, Ukraine, 1994

Major: Mechanical Engineering

Position Held:

Teaching Assistant
Department of Mechanical and Industrial Engineering
New Jersey Institute of Technology, Newark, NJ, 1999

Research Assistant
Department of Mechanical and Industrial Engineering
New Jersey Institute of Technology, Newark, NJ, 1997-1998

Presentations and publications:

E.S. Geskin, L. Tismenetskiy, F. Li, P. Meng and D. Shishkin, "Investigation of Icejet Machining", **Proceedings of 9th American Waterjet Conference**, Houston, Texas, August 1997, pp. 281-290.

E. Geskin, D. Shishkin, K. Babets, "Investigation of Icejet Machining", **Proceedings of 1999 NSF Design and Manufacturing Grantees Conference**, Long Beach, California, January 1999.

- E. Geskin, L. Tismenetskiy, D. Shishkin, "Development of a robotic system for cleaning of chemical reactors", **Proceedings of the 9th American Waterjet Conference**, Houston, Texas, August 1997, pp. 631- 644.
- E. Geskin, D. Watts, L. Tismenetskiy, E. Bachromi, and D. Shishkin, "Testing of the waterjet based system for reactors cleaning", **Proceeding of the 14th International Conference on JETTING TECHNOLOGY**, Brugge, Belgium, September 1998, pp.535-544.
- E.S. Geskin, L. T'ismenetskiy, D. Shishkin, K. Babets, "Development of IceJet Machining Technology", **First International Symposium on Mineral Resources Quality Control**, Krivoy Rog, Ukraine, 1996, pp. 132-135.
- E.S. Geskin, D. Shishkin, K. Babets, "*Ice, Cryogenic and Polymer Added Jets* ", Chapter in the Book, "Abrasive Water Jet, a View on Future", June 1999, to be published by Institute for Industrial Technologies and Automation.
- E. S. Geskin, D. Shishkin, K. Babets, "Icejet Cleaning Technology", **XI American Waterjet Conference**, Houston, Texas, August 1999, to be published.
- K. Babets, E. S. Geskin, D. Shishkin, "Application of Artificial Intelligence for Waterjet Modeling and Optimization", **Second International Symposium on Mineral Resources Quality Control**, Yalta, Ukraine, 1999, to be published.

**To the memory of my father,
God rests his soul**

ACKNOWLEDGMENT

The author wishes to express his sincere gratitude to his advisor, Professor Ernest S. Geskin, for his guidance, constant encouragement, and patience throughout this investigation.

The author also wishes to express his sincere gratitude to Dr. Z. Ji and Dr. R. Sodhi who have kindly read through the original manuscript and provided valuable suggestions.

The author appreciates the timely help and suggestions from all the Waterjet Laboratory members.

The author would also like to express his gratitude for the support from his family, especially his parents and sister.

TABLE OF CONTENTS

Chapter	Page
1 INTRODUCTION.....	1
2 MISSION STATEMENT.....	6
3 PROPERTIES OF WATER ICE.....	9
4 EXPERIMENTAL SET UP.....	14
5 INTRAIMENT OF ICE PARTICLES BY THE WATER STREAM.....	22
6 FORMATION OF ICE WATERJET.....	24
7 EXPERIMENTAL STUDY OF ICE WATER JET MACHINING.....	27
8 EXPERIMENTAL STUDY OF ICE AIR JET MACHINING.....	31
9 CRYOGENIC JETS.....	34
10 DEVELOPMENT OF USERFRIENDLY GREEN CLEANING SYSTEM.....	38
11 FUTURE WORK.....	46
12 CONCLUSION AND RECOMMENDATION.....	49
APPENDIX A LABORATORY SCALE PROTOTYPE OF ICEJET FORMATION....	51
APPENDIX B FIDAP MODELLIMG OF PARTICLES MOTION.....	57
APPENDIX C PHOTOGRAPHS OF SAMPLES OF WATERJET AND ICEJET CUTTING.....	60
APPENDIX D PHOTOGRAPHS OF SAMPLES OF ICE AIRJET CLEANING.....	66
BIBLIOGRAPHY.....	88

CHAPTER 1

INTRODUCTION

Thermodynamic analysis of material removal and common sense indicate that an ideal tool for material shaping is a high energy beam, having infinitely small cross-section, precisely controlled depth and direction of penetration and no effect on the generated subsurface. The production of the beam should be relatively inexpensive and environmentally sound while the material removal rate should be high and should exceed the rates of existing material removal techniques. No such beam currently exists. The laser beam, embodying some of the above features, constitutes an effective material-processing tool. Laser applications for surface modification, welding and precision machining is well understood and documented. At the same time the physics of the laser-material processing limits the use of this beam. Laser processing is based on the material evaporation and results in the formation of the heat affected zone, which irreversibly changes the properties of the material. In some cases, for example during surface modification, such a change is necessary. In other cases, for example in eye surgery, such change is damaging. Another shortcoming of the laser processing is its limited ability to control energy density and the shape of the beam. Still another shortcoming of the lasers is the complexity and high cost of the equipment.

A narrow stream of high-energy water, so called waterjet, comes close to becoming an ideal tool. Waterjet (WJ) is able to remove a material without subsurface damage. Because of this, WJ constitutes one of the most common tools for surface processing. During last 30 years high speed WJ was adopted by industry as a machining

tool. At water pressure at the order of 340 MPa (50,000 psi) water velocity approaches 800 m/s and specific energy of the jet is comparable with that of the laser beam. However machining ability of WJ is far below than that of the laser. The principal shortcoming of WJ is the low efficiency of the energy transfer between the jet and the workpiece. This results in low productivity of WJ machining. More important, WJ can be applied to machining of comparatively soft materials only.

The energy transfer and subsequently the mode of material removal change dramatically by addition of abrasive particles into the water stream. The abrasive waterjet (AWJ) generated as the result of such an addition enables us to machine practically any engineering material. The rate of removal of “hard -to -machine materials” by the use of AWJ is comparative if not superior to other material removal processes. Because of his capability AWJ in a short time became one of leading machining technologies. In the course of AWJ particles are sucked into a mixed chamber due to vacuum created by the jet. Mixing of water and particles and formation of a homogeneous flow occurs in a focusing tube, which form a highly erosive slurry jet. The various applications of AWJ are well understood and documented.

However, AWJ is a mixture of water and particles and this imposes a number of limitations and inconveniences. The energy efficiency of AWJ is still low, although acceptable, mixing of the water and particles imposes a severe limitation on the minimal usable jet diameter, special provisions are required for particles supply and disposal, the addition of abrasive particles increases the cost of processing and its environmental impact.

It would be highly desirable to enhance the productivity of WJ and yet avoid solid emission. This objective can be achieved by the replacement of conventional abrasive materials by ice particles, thus resulting in formation of ice-waterjet (IWJ). The solid particles, regardless of their properties, are able to erode the material in the impingement site. Thus, ice can be used as an abrasive media. Termination of the negative environmental effects of AWJ machining constitutes a significant advantage of IWJ. Most important, however, is the feasibility of the use IWJ for shaping of material in food, electronic, space and other branches of industry where any contamination in the course of processing is impossible. One of the potential applications of IWJ is medicine. Another significant advantage of the water ice abrasives is their availability and low cost. There is no need to deliver and store ice. The only commodities needed for fabrication of water ice particles are water and electricity.

It is highly desirable to convert an environmentally unfriendly, but widely adopted, AWJ machining into a green ice blasting process. However, it is necessary to overcome significant technological difficulties in order to attain adoption of IWJ by the practice. The erosion of substrate by impinging particles is due to stress waves generated in the course of impact. The strength and duration of these waves depends on mechanical properties of the impinging particles. The elastic characteristics of conventional abrasives are superior to that of ice. Thus, these abrasives constitute much more effective machining tool. Despite a low productivity, the use of water ice will be readily acceptable by food, biomedical and other industries where the contamination of the substrate constitutes the primary concern of users.

The most important problem, which actually impedes adoption of the ice-jet technology, is the difficulties in the generation and handling of ice abrasives. Regular abrasives are stable at all practical ranges of operational conditions, while ice particles can exist only at subzero temperature. Maintaining such a temperature within the nozzle and within the jet is an extremely difficult task. Ice particles tend to pack and clog the supply lines. The adherence between the particles increases dramatically as the temperature approaches 0 C. Thus prior to entrance in the nozzle ice particles should be maintained at a low temperature. These and some other problems prevent adoption of IWJ. In order to assure the acceptance of IWJ by the industry, it is necessary to develop a practical technology for formation of the ice-water slurry.

IWJ jet is one of few practically available green machining tools. The need in such tools is rapidly growing. Although no practical application of IWJ is reported so far it is safe to predict that water ice constitutes one of the most promising technological tools.

There are several reports of the application of the air-ice jets (Herb and Visaisouk, 1996, Liu et al, 1998, Geskin et al, 1999)[1,2]. The advantage of air driven system is the feasibility to maintain a low temperature of the stream and a high pressure gradient in suction lines. Because of this it is expected that this technology will be adopted by the practice fairly soon. However machining ability of the ice airjet (IAJ) is insufficient for removal of the most of engineering material. Thus, most probably, this technology will be adopted for surface processing, while material shaping will be carried out by IWJ.

The substantial advantage of IAJ is elimination of off-products, solid or liquid, while its disadvantage is the use of gas as a source of momentum. Low density of the gas

media limit machining ability of the jet. The use of cryogenic fluid (liquid nitrogen, ammonia, and carbon dioxide) enables us to eliminate off-products as well as substrate contamination, while the sufficient momentum is delivered to the impact zone (Dunsky and Hashish, 1996, Hashish and Dunsky, 1998, Sherman and Adams, 1996)[3,4,5]. The obvious difficulty of this technology is the necessity to maintain a working fluid at a cryogenic temperature.

The use of particles as energy carriers in the impingement zone is one of ways of improving momentum transfer from the fluid to the substrate. The increase of the density of the fluid momentum at the impingement zone is another approach to this problem. Highly coherent fluid flow readily passes through a layer of a rejected fluid. Thus, momentum losses of the jet are reduced. However, the mechanisms of the energy delivery to a substrate by a coherent jet and impacting particles are quite different. Material removal by particles is due to the erosion, while penetration of a fluid jet is due to the stagnation pressure. Because of this even coherent jet can penetrate only comparatively soft materials. The most effective way to increase jet coherence without water contamination is addition of small amount of polymers (Summers, 1995, Lombardi, 1997)[6,7]. The improvement of the jet penetration by the addition of polymers is widely adopted by the industry.

In this study we discuss the potential of the reduction of emission of jet processing and the obstacles to the creation of the green jetting technology. Although various approaches to this issue are examined, the main attention is paid to the application of water ice, particularly to the contribution of the authors to this problem.

CHAPTER 2

MISSION STATEMENT

The mission of the proposed work is to develop a generic "green", material processing technology. A fluid-particle stream will be used for such processes as cleaning, decoating, polishing, pinning, cutting etc. A desired change in the surface properties will be achieved by the selection of the stream characteristics.

One of the immediate objectives of this work is to develop a "green", rugged, readily deployable system for derusting and depainting. The system will require the minimal logistics. With no or minor modification the system will be applicable to "green" cleaning, depainting and other decoating operations.

The sought technology is in the final analysis conversion of an environmentally hostile, but widely adopted, process of sand blasting into a green ice blasting technology. However, the hardness of the ice is much lower than that of the sand and process modification is required to account for the change of the blasting media. The peculiarities of the ice behavior constitute another obstacle. Ice particles tend to pack and the adherence between the particles increases dramatically, as the temperature approaches 0 C. Even at low temperature motionless particles brought into contact tend to clog. The hardness of ice is maximal at the temperature below - 25 C and decreases as the temperature approaches 0 C. Thus the ice particles should be maintained at a low temperature and duration of the contact between particles should be minimal. These conditions should be met in the course of the particle life. Finally, it is possible that at

some spots air-ice particle mixture will not remove the rust. More aggressive high speed water or water-ice blasting will be used to overcome this problem.

The following innovations will assure the successful operation of a proposed system:

- The system will integrate the use of the air-ice, water and the water-ice streams. The air-ice stream, which generates no emission will constitute the principal rust-removing tool. The rust spots having specially strong adherence to the substrate will be removed by the water or ice-water jet.
- The operational conditions will be selected so that only minor spots will need the water treatment.
- Off-products of ice-air derusting can readily be contained and process will be carried out with minimal or no emission.
- Water freezing will be carried out at optimal temperature and pressure, so that the desired ice properties will be assured.
- The temperature along the water freezer will be distributed so that the stresses generated in the course of water freezing in an enclosure will be minimal.
- Heat removal during water freezing will be carried out by a refrigerant, if there is no limitation on electrical supply or by liquid nitrogen if such a limitation exists.
- Ice generation (water freezing) and ice decomposition (grinding) will be carried out at the same rate, thus the duration between particle formation and particle impact will be minimal.
- Conditions of ice grinding will assure optimization of the particle size.

- Conditions of air acceleration in the nozzle will assure optimization of the air-particle mixing in the mixing chamber, that is characteristics of the slurry stream.
- The particles temperature will be held below - 25 C during the particle life, that is during the time between the particle formation and the particle impact.
- The optimization of the impact conditions (rust separation) will be attained by the selection particles flow rate, jet traverse rate and standoff distance.

The compressor, used for generation of the air stream will also be used for air removal from the impact zone, that is emission in the course of derusting will be eliminated or at least reduced.

CHAPTER 3

PROPERTIES OF WATER ICE

The practical application of the water ice as a machining media is determined by ice properties. The phase diagram showing the regions of the existence of various forms of solid ice as well as the boundary between the solid and liquid states is depicted on Figure 3.1 (Hobbs, 1974, Fletcher, 1970) [8,9].

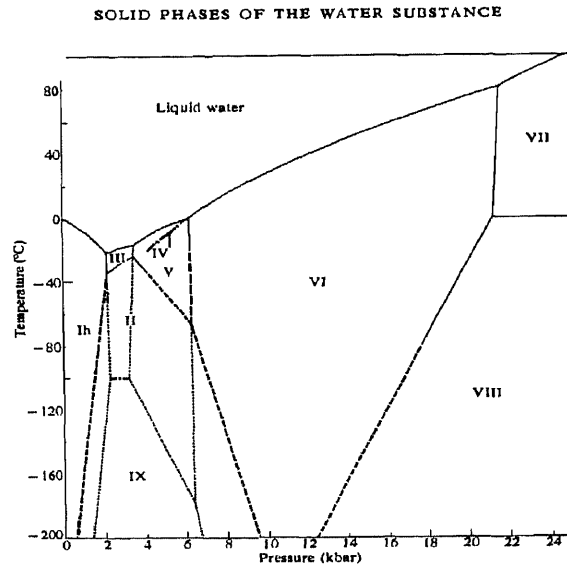

Figure 3.1 Phase diagram of water. (Hobbs, 1974)

Although the properties of various phase modification of ice vary in a wide range, a practical importance has Ice I existing at the modest pressure (below 200 MPa). The important feature of ice I is the reduction of a melting temperature with increase of the pressure. The minimum temperature of the liquid water is attained at the pressure about 200 MPa and is equal to -20°C . As it follows from Figure 3.1 the reduction of the water

solidification temperature from 0 C to - 20 C as the pressure rises from 0.1 MPa to 200 MPa is almost linear. This property determines the feasibility of ice formation by cooling of compressed water to the temperature slightly exceeding solidification temperature at this pressure and subsequent isoenthalpic water decompression in a nozzle. After the nozzle water pressure drops to 0.1 MPa, a part of water is converted to ice. The energy balance of the flow prior and after the nozzle determines the fraction of the frozen water. This fraction is determined by the equation:

$$x = \frac{C_p(T_2)T_2 - C_p(T_1)T_1}{h + C_p T_2} \quad (1)$$

where x is the fraction of water converted into ice during an expansion, $C_p(T_p)$ is the specific heat of water at constant pressure at temperature T, kJ/kg C, T_1 and T_2 are the temperatures of water prior (T_1) and after (T_2) an expansion, C, h is the latent heat of water freezing at T_2 , kJ/kg.

Another important ice feature determining particle behavior in the course of impact is ice elasticity. At the temperature range of - 3 C to - 40 C ice behaves as almost perfect elastic body. Hook's Law is obeyed if the stresses in the ice are below than certain level and are applied during a short period of time (Hobbs, 1974, p. 256) [8]. The dynamic elastic properties of ice (Fletcher, 1970, p 173) [9] at - 5 C are characterized by the following data: Young modulus (E) = 8.9-9.9 GPa, Rigidity modulus (G) = 3.4-3.8 GPa, Bulk modulus (K) = 8.3-11.3 GPa, Poison's ratio (χ) = 0.31-0.36. For comparison, for Aluminum Alloy 1100-H14 E = 70 GPa and G= 26 GPa. For silica glass E = 70 GPa.

If a columnar ice is stressed perpendicular to the long direction of the column the static Young modulus in bars is determined by the equation:

$$E=(5.69-0.64T)*10^4 \quad (2)$$

where, temperature T is given in C. The dynamic Young modulus of ice increases almost linearly from 7.2 GPa at -10 C to 8.5 GPa at - 180 C, and is independent from direction of loading. The data above shows that the ice powder can be consider as a soft blasting material and used accordingly.

One of the main issues in the use of the ice powder is sintering of ice particles and their adhesion to the surface of the enclosure. The strength of the adhesion of ice particles depends on the ice temperature. The effect of the temperature on the adhesion forces is shown in Figure 3.2.

As it follows from this figure it is necessary to maintain ice temperature below - 30 C to prevent sintering of the particles. The sintering is also determined by the duration of the particles contact.

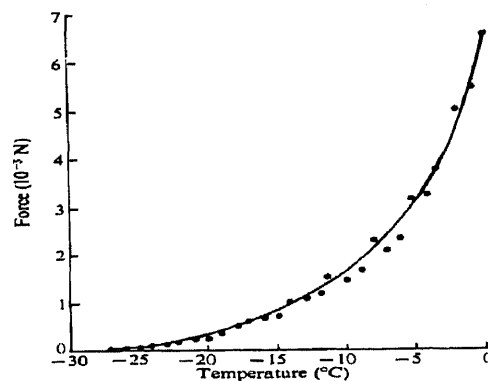

Figure 3.2 Strength of the adhesion of ice particles. (Hobbs, 1974)

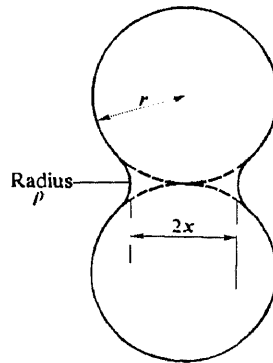

Figure 3.3 Schematic of the sintering of ice particles. (Hobbs, 1974)

The radius of the neck, which forms between two ice spheres, brought into contact during time t at temperature T Figure 3.3 is determined by the equation

$$\left(\frac{x}{r}\right)^n = \frac{A(T)}{r^m} t \quad (3)$$

where x is the radius of the neck, r is the radius of sphere, $A(T)$ is a function of the temperature, which depends on the mechanism of sintering, n and m are the constants, which are also determined by the mechanism of sintering. As it follows from equation (3) it is necessary to prevent the contact between particles in order to avoid particles sintering.

Ice tends to adhere to a solid surface where the ice nuclei are generated. The strength of the adhesion to the polished steel is illustrated by Figure 3.4.

As it follows from this picture moisture contained in the atmosphere in the course of ice transportation will bring about the adherence of the ice to walls or sintering of ice particles. Both phenomena result in the formation of a plug and clogging of the conduits.

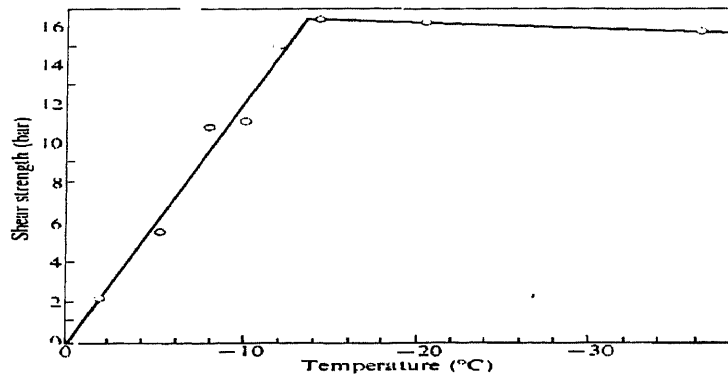

Figure 3.4 Shear strength of ice adhesion to stainless steel. (Hobbs, 1974)

CHAPTER 4

EXPERIMENTAL SET UP

The preliminary experiments involved cooling of the compressed water prior to the water nozzle. Cooling was accomplished by submerging of the supply pipe into the liquid nitrogen bath and resulted in the improvement of WJ performance. However no ice particles have been found in the stream. The most probable cause of the observed improvement was reduction of steam generation in the course of jet formation and thus increase in the stream coherence.

In order to evaluate the effect of ice particles on the jet-workpiece interaction a simple system for ice-particles generation and entrainment by WJ was constructed Figure 4.1. In this system ice cubics produced by a regular icemaker were fed into a grinder. In order to prevent ice melting the dry ice (solid CO₂) was added to ice. The particles generated in the grinder were fed into a conventional abrasive nozzle via a conventional system for abrasive supply. A coil installed prior to the nozzle was submerged into liquid nitrogen and used for water cooling prior to expansion. The nozzle in the system Figure 4.1 is motionless and thus was used for drilling only. IJ material cutting was carried out at the 5-axes robotics workcell. The compressed water for the performed experiments were supplied by Ingersoll-Rand Co. made intensifier with maximum available pressure of 340 MPa.

The experiments were carried out at the water pressure of 320 MPa. The nozzle diameter was 0.175 mm, the diameters of the focusing tube were 0.75 and 1.075 mm while the stand off distance ranged from 3 to 5 mm. The traverse rate during cutting was

25 mm/min. The experiments involved cutting and drilling of steel, aluminum, titanium and composite samples. The machining was carried out by IJ and WJ at similar operational conditions. The developed ice supply system was not able to provide steady flow of ice particles as well as to assure the control of particles size and prevent particles melting. In order to evaluate the effect of particles addition on the machining, water during the reported experiments was not pre-cooled.

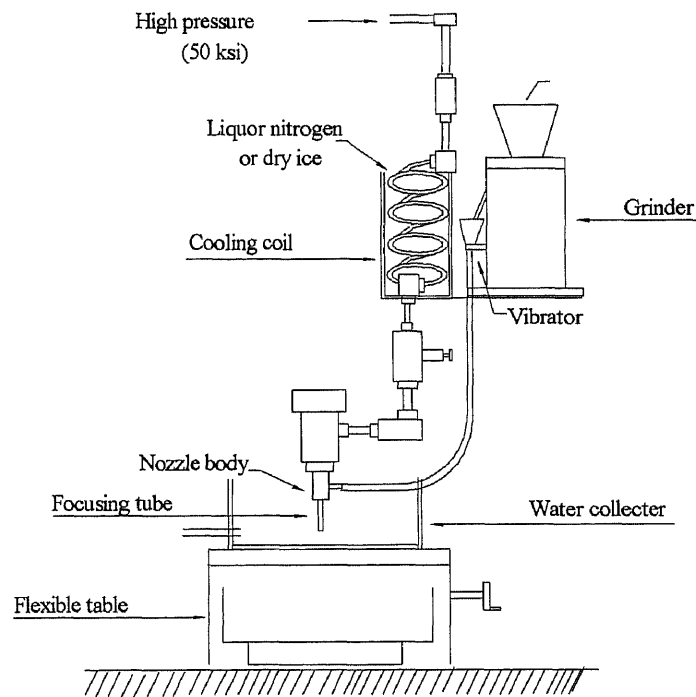

Figure 4.1 Schematic of IJ Cell

Clogging of ice particles in the course of ice supply from the source (bunker, ice grinder, etc.) to the focusing tube constitutes the main barrier in the system design. The clogging occurs as a result of any appearance of water within the particles stream. When started, the chain reaction of clogging is developing almost instantaneously. Water within

the ice stream can be generated due to the local melting or moisture condensation and it is difficult to prevent its appearance.

The thermodynamic analysis of conditions of the ice formation, transportation and entrainment by the waterjet enabled us to determine the potential site of the moisture generation within the ice supply system. It was found that clogging could be prevented if a part of the ice supply line is maintained at a subzero temperature so no moisture is generated. The temperature of the rest of the supply system is 0 C so moisture generation does not result in particles agglomeration. Another barrier in the system operation is generation of an adequate driving force acting on the ice flow. This was attained by the use of air ejector. Because the ejector is fed by a compressor without aftercooler, the walls the ejector are heated. In order to eliminate the effect of the stream exiting the ejector on the jet formation in the mixing chamber there is a gap between the exit of the ejector and the receiving port of the mixing chamber. At this conditions the entering of the practical ice particles in the nozzle is assured, while the interference between the air-particles and water streams are eliminated.

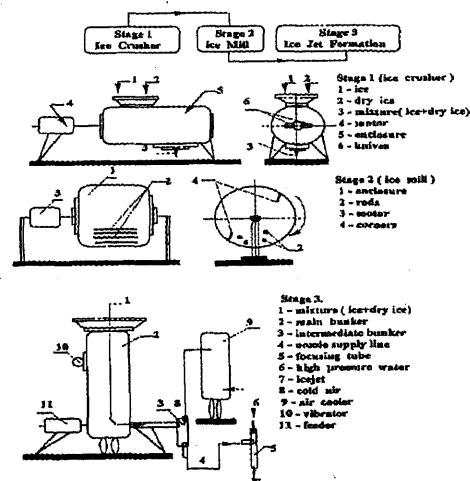

Figure 4.2 Ice particles supply at subzero temperature .

In the constructed system ice crusher, producing particles and a bunker containing these particles are maintained at a subzero temperature. The ejector drives particles from the bunker to the receiving port of the nozzle head. The body of the ejector is heated. The operation of the system was stable.

Another experimental set up system was introduced during IJ System development. An experimental set up for injection of ice particles into the water stream is shown in Figure 4.2. Ice was prepared in a conventional ice making machine and fed into an ice milling system. After two stages of milling, ice particles of desired dimensions were separated and via a vibrational feeder delivered into a bunker. Dry ice was used to prevent melting and lapping of particles. Injector transfers particles from the bunker to the waterjet machining cell. The particles transport was carried out by CO₂, which was also used as a cooling media. Gas and particles were separated in a cyclone. After the cyclone particles were moved to the second bunker located at the site of the abrasive bunker, while the gas was returned to the first bunker and used for additional cooling of the particles. Dry ice was used for the cooling of the second bunker. Particles stored in the second bunker were supplied via hose to the abrasive port of the cutting head. Similarly to abrasive particles ice is driven to the cutting head by a suction developed by the waterjet. Mixing of the particles and water and formation of ice jet is similar to the formation of AWJ.

The developed IJ was used for cutting of various metals (titanium, stainless steel, aluminum). The same samples were cut by WJ and AWJ in order to compare these three technologies. The cutting was carried out at the water pressure of 340 MPa, water nozzle diameter of 250 micron, focusing tube diameter of 1100 micron, stand off distance of 2.5

mm, traverse rate at IJ and WJ cutting was 5 cm/min and 25 cm/min during AWJ cutting. Barton Mines garnet 220 was used for for abrasive cutting. The rate of abrasive flow was 65 g/min, while the estimated rate of ice particles supply was 63 g/min and estimated size of ice particles was 2.5 – 3.0 mm. The traverse rate of 5 cm/min was the maximum traverse rate at which IJ cutting was possible.

Other series of experiments involved cooling of the water stream after the nozzle were carried out. The carbide focusing tube was replaced by a finned copper tube Figure 4.3, submerged in a liquid bath.

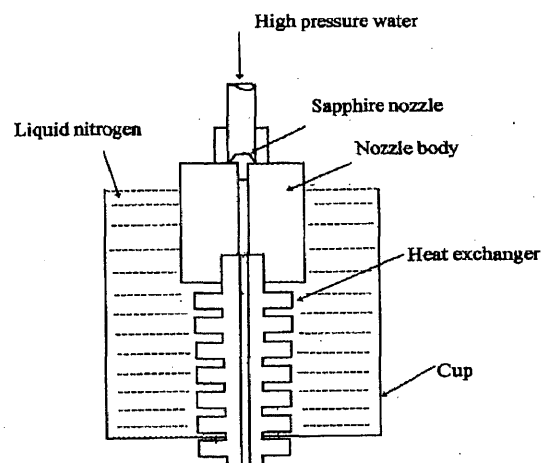

Figure 4.3 Schematic of Ice Formation within the High Speed Water Jet.

Water exiting from the nozzle was partially frozen in the copper tube and the stream exiting the copper tube impinged on the sample surface. The change of the topography of the impact zone was examined in order to evaluate jet properties. In order to maximize probability of ice formation water flow rate was minimal. This was achieved by the maintaining water pressure at the minimal level of 68 MPa. The diameter of the

nozzle was 75 micron while the diameter of the copper tube was 500 micron. The cooling system and consequently the nozzle were motionless and all operations except for drilling were carried out by manual motion of the sample.

The principal feature of both systems was elimination of water cooling prior to the nozzle. No changes in the conventional system of the water supply to the nozzle and acceleration in the nozzle were made. This not only simplified the system design but also eliminates water freezing in the pipeline, which constituted the major problem during the previous experiments.

The most frequent site of the ice agglomeration was the port of the particle entrance in the mixing chamber. Analysis of the conditions of the heat exchange in this chamber showed that the phenomena in question are due to the solidification of the water vapor at the entrance into the mixing chamber. Due to the water vaporization in the course of isoenthalpic decompression in the orifice the vapor density in the atmosphere of the chamber is high. The contact between the wet air in the chamber and the entering cold air results in the ice formation at the port of the air-powder entrance. Formation of the ice lumps within the air-ice flow resulted in the clogging of the supply line. Heating the area around the nozzle head entrance eliminated the problem above.

The system for formation of ice particles, accounted for the requirements above were constructed Figure 4.4.

The system operated as following. Ice and dry ice are supplied into the first stage of the crushing. Here the piston 1 moves ice to the rotating knives 2. The obtained coarse particles are supplied to the screw conveyer of the second stage. This conveyer delivers particles to the rotating knives, which generate fine particles. These particles are supplied

into bunker 8 and then to the vibrator 10. The vibrating rod 9 assures continuity of the flow through the bunker 9. The vibrator 10 supplies particles to the bunker 12 and then to the tube 13. The suction created by the water nozzle assures delivery of the particles to the nozzle head. The heater 14 prevents clogging of the of the entrance port. Vibration of the crushers, bunkers and intermediate lines assures continuity of the powder flow.

The rate of the vibration as well as operations of both stages of the crushing is controlled by PC via the microprocessor MP. The crusher bunkers and vibrator 10 are located within the insulated enclosure. The supply line 13 is also located in the enclosure. The air at the temperature of -70 C is supplied into the enclosures.

The tests showed the stability of the operation of this system.

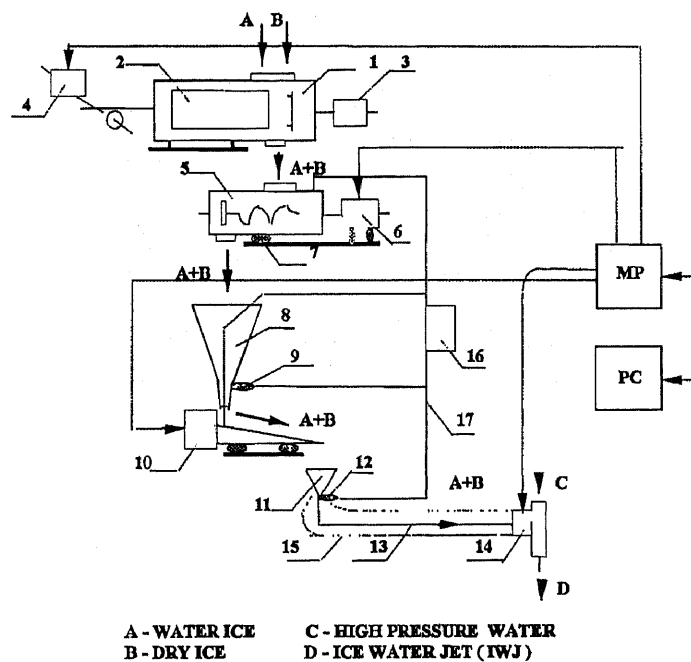

Figure 4.4 Schematic of the System for Ice Formation.

1- the first stage of crushing, 2- the piston, 3- the knives motor of the first stage of crushing, 4- the piston motor, 5- the second (precise) stage of crushing, 6- the knives motor of the second stage of crushing, 7- the amortizator of the second stage of crushing,

8- the intermediate supply bunker #1, 9- the amortizator of the intermediate supply bunker #1, 10- the electromagnetic vibrator, 11- the intermediate supply bunker #2, 12- the amortizator of the intermediate supply bunker #2, 13- the intermediate supply line, 14- the electrical heater, 15- the insulation enclosure of the intermediate supply line, 16- the adjustable speed and force vibrator, 17- the vibration transfer stainless steel rods.

The detalization of the system which shown above including electrical schematic is presented in APPENDIX A

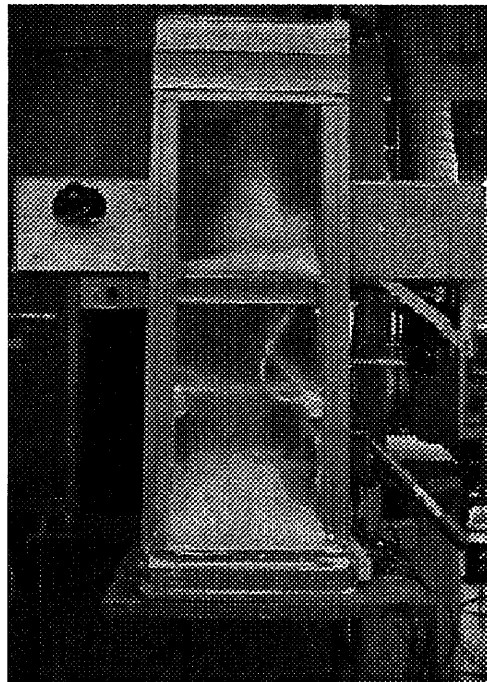

Figure 3.5 The System for Ice Formation (General View).

CHAPTER 5

ENTRAINMENT OF ICE PARTICLES BY THE WATER STREAM

Abrasive nozzle head assures entrainment of abrasive particles by water stream and formation of the homogeneous or almost homogeneous slurry. However, as it was shown earlier (Raissi et al., 1996, Osman et. al, 1996) [10,11] the mixing chamber constitutes an "intermediate storage" of particles, fed from the inlet port and feeding the focusing tube. Our FIDAP modeling of particle entrainment by the waterjet Figure 4.1 demonstrates this conclusion. Because conventional abrasive particles constitute a thermodynamically stable system, the dwell time in the mixing chamber has no effect on the system performance. At the same time the ice particles can survive at a temperature above 0 C only very short time. It is necessary to maintain water temperature after the nozzle at a near zero level in order to deliver solid ice particles to the impact surface. Another way to address this issue is to reduce the dwell time of the particles in the mixing tube.

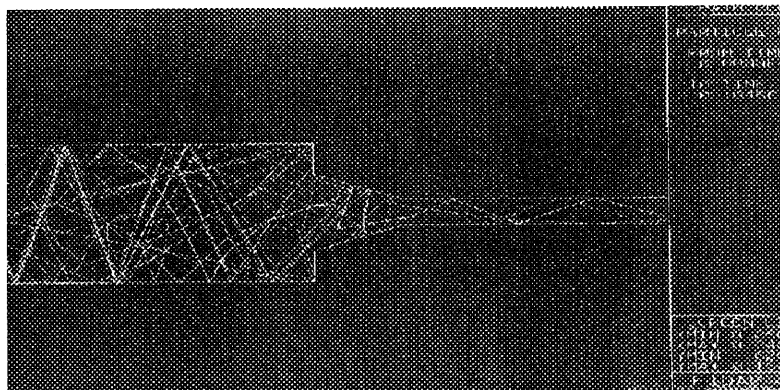

Figure 5.1 Fidap modeling of particles motion in the mixing chamber. Notice extended dwell time of particles in the mixing chamber.

APPENDIX B shows all the results of FIDAP modeling on ice particles motion into the mixing chamber.

CHAPTER 6

FORMATION OF ICE WATERJET

There are several possible techniques for IWJ formation. Ice particles can be produced separately and then injected into the water stream similarly to abrasive particles. In this case, at least in principle, we can generate ice particles of the desired dimensions, having maximal hardness. The obvious shortcoming of this technology is the need of auxiliary systems for the particles production and transportation. More important deficiency of particles entrainment into the water jet is a necessity to use a focusing tube for the formation of a slurry flow. The minimal diameter of a focusing tube, that is the minimal diameter of the stream, exceeds 350 micron.

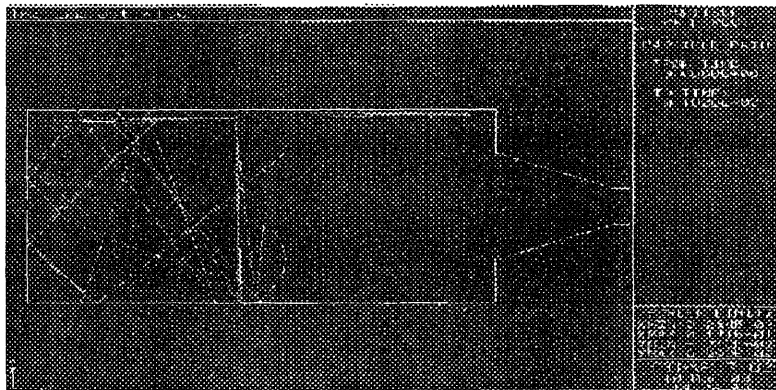

Figure 6.1 Fidap modeling of particles motion in the mixing chamber. The end of a trajectory is due to melting.

IWJ can be created by the formation of the ice particles in the course of jet expansion in the nozzle. The movements of ice particles in the mixing chamber shown in

Figure 5.1. Thermodynamics of ice (Hobbs, 1974) [8] allows us to reduce the temperature of the compressed water much below 0 C without freezing. At the pressure of 2,000 psi (13.8 MPa) water temperature can be reduced down to - 25 C. During the expansion in the nozzle, while water pressure reaches 1 bar part of water is converted into ice. Due to enthalpy release during the solidification water temperature increases, but it cannot exceed 0 C. The fraction of water converted into ice is determined by the difference between water enthalpies prior and after the nozzle and by the enthalpy conversion into kinetic energy of the stream during water acceleration. The shortcomings of this technology are the difficulties of the control of particle nucleation and growth and, the most of all, a small margin of enthalpy available for the solidification.

Finally, ice formation is possible by cooling compressed water prior to the nozzle and additional water cooling in the focusing tube. Heat removal in the focusing tube can be attained, for example, by submerging the focusing tube into a cooling media. This technique enables us to increase the rate of the ice generation, but results in the increase of IWJ diameter due to the use of the focusing tube. However, in this case the focusing tube is not used for mixing of water and particles. Because of this the diameter of the focusing tube and thus stream diameter are significantly less than those during particles addition. Cooling of the focusing tube requires much simpler facility than preparation and handling of ice particles. Thus, each of the above technologies has shortcomings and benefits and further experiments are required to specify the areas of applications of each technology.

Previous studies of IWJ machining reported by Galecki and Vickers (1982) [12] and Truchot et al (1992) [13] involved the examination of stream freezing and ice

particles supply in the water stream. These authors reported that addition of ice particles into WJ improves cutting of soft materials, that is the materials that can be cut by a conventional WJ. The study of the formation and the use of the ice jet (IWJ) has been carried by Waterjet Technology laboratory of NJIT since 1993. (Geskin et al, 1995, 1995a, 1996, 1997, 1997a, 1999, Li at al, 1995, 1996) [14-21].

CHAPTER 7

EXPERIMENTAL STUDY OF ICE WATER JET MACHINING

The operation of the system Figure 4.1 demonstrated the feasibility of the use of this system for IJ formation. The addition of ice to WJ completely changed the mode of the jet-substrate interaction. Particularly, cutting of different metals became possible. The principal shortcoming of the system was particles clogging at a high rate of particles supply. The process was stable until a particle or several particles are stuck at the entrance of the cutting head. Then ice plug developed. The formation of this plug was readily detectable by the change of the noise of the jet. If, however, ice supply was stopped, the nozzle suction destroyed the plug.

The performed experiments showed the strong effect of ice addition. If WJ is able to remove a thin layer, IJ assures metal cutting. The rate of cutting was, however, much less than that of AWJ. The low productivity of IJ is due to the low cutting ability of ice particles, comparative to that of abrasive particles. It is also due to low flow rate of ice supply. At this stage it was impossible to evaluate the comparative contribution of each of these factors. We expect that improvement of the procedure of particles formation and prevention of system clogging will improve process productivity, which might reach the level AWJ machining.

The important feature of IJ cutting of stainless steel is a narrow kerf. The width of the kerf is equal to that of WJ and substantially less than that of AWJ. Most probably, this reduction is due to prevention of steam formation in IJ and , thus, reduction of the jet diameter. Similar kerf width reduction was observed in the course of cutting of titanium,

aluminum and copper. In all cases above the observed IJ kerf was less than that of AWJ. At the same time in the course of copper cutting a wide strip of eroded surface was developed. The width of this strip is comparable to the width of AWJ kerf. The formation of the eroded area on the copper surface is probably due to formation of an array of slow particles outside the main stream. The kinetic energy of these particles is not sufficient for significant surface modification of metals, such as steel, titanium and even aluminum occurs. This energy, however, is sufficient for substantial erosion of a copper surface.

Another series of experiments involved partial freezing of the water stream. Ice particles were generated in the water stream passing the copper heat exchanger. The presence of these particles was identified by the erosion of a surface subjected to the impact of the jet. No change in the surface topography occurs without water cooling, while when the heat exchanger was submerged into the liquid nitrogen surface erosion was readily observed. Moreover, the dimples generated by the cooled jet are similar to that generated by the impinging AWJ. Another indication of the formation of ice particles is the change of the noise generated by jet. The character of this noise changed substantially when the nozzle head was submerged in the nitrogen bath. Control variable in this case was the depth of submerging of the copper tube into the nitrogen bath. This depth in the final analysis determines the rate of heat removal from water. An excessive cooling rate results in water freezing, while at an insufficient rate of heat removal no ice formation was observed.

The results of the surface erosion by the impinging IJ, generated by the stream cooling were also investigated. The impinging jet was able to drill steel and remove rust. No change of the surface geometry was observed without jet cooling.

The results of IJ and WJ drilling and cutting are shown in Tables 7.1 and Table 7.2. The presented results show the substantial improvement due to the ice entrapment. For example, WJ was not able to cut an aluminum sample while the ice addition assured process completion. IJ was able to create a through hole, while WJ was not able to bring about any noticeable material removal. WJ was not able to penetrate through a graphite composite and IJ impact resulted in the composite delimitation while the ice addition assured hole generation.

Performed research evidently demonstrates potential effectiveness of IJ machining. It is possible to use IJ for shaping of various materials, for example steel and titanium. IJ machining is uniquely clean as well as efficient technology. As it is shown IJ cutting results in the formation of a clean surface with minimal material removal. No existing technology is able to assure material separation at such kerf width without modification of the generated surface. At the same time substantial improvement in the process technology is necessary. The performed work showed that IJ could be generated by cooling of the water flow after the nozzle exit or by ice particles supply into the stream. However, a reliable technique for formation of ice particles is yet to be developed.

The pictures of WJ and IJ cutting and drilling profiles are presented in APPENDIX C.

Table 7.1 Comparative study of material drilling by WJ and IJ.

Number of samples	Materials	Thickness (mm)	Time of Drilling (min.)	Depth of Penetration (mm)		Diameter of Holes (mm)		Size of Ice Particles
				Water	Water-Ice	Water	Water-Ice	
1	AL	20	2	4.3	10.5	1.4	2.8	Large
2	AL	3.1	1	throu	throu	~	~	Large
3	AL	5.4	3.5	3.6	throu	1.1	1.1	large
4	AL	5.3	2.0	3.2	throu	1.1	1.1	Large
5	Regular Steel	6.4	5.6	2.5	throu	1.1	1.1	Large
6	Regular Steel	2.9	2.1	2.1	throu	1.1	1.1	Small
7	Ti-alloy	12.9	4.2	3.1	4.3	1.2	1.2	Small
8	Graphite Epoxy-Based Composite	7.4	5 sec	5.3	throu	1.3	1.2	Large
9	Stainless Steel	3.2	3.0	2.5	2.9	1.1	1.1	Small
10	Stainless Steel	2	8.0	0	1.7	1.1	1.1	Large

Table 7.2 Comparative results of materials cutting by IJ and WJ.

Number of Samples	Materials	Thickness (mm)	Speed (cm/min.)	Depth of Penetration (mm)		Size of Ice Particles
				Wat.J.	Ice.J.	
1	Al	5	2.5	3.1	Total Perforation	Large
2	Al	5.4	2.5	3.6	Total Perforation	Large
3	Stainless Steel	1.3	2.5	0.5	Total Perforation	Large
4	Stainless Steel	1.3	2.5	0.5	0.7	Large
5	Stainless Steel	3.2	2.5	0.7	2.1	Large
6	Stainless Steel	3.2	2.5	0.7	1.0	Small

CHAPTER 8

EXPERIMENTAL STUDY OF ICE AIR JET MACHINING

The use of ice particles is simplified if the particles are entrained in the air stream. There is a number of suggested air-ice based technologies. One of the firsts of such technologies is a car washing machine, utilizing ice particles (US Patent, 1955). The stream of the charged frozen particles controlled by a set of coils was directed at treated surfaces (Kanno et al, 1991) [22]. Szijcs (1991) [23] proposed cleaning of the sensitive surfaces by the impact of the fine grade blast material and air. The atomization of the liquid in the air stream and subsequent freezing of the generated fine droplets form the blast material. The freezing is achieved by the addition of the refrigerant (N₂, CO₂, Freon) into the stream in the mixing chamber or by the addition of refrigerant into the jet after the mixing chamber. The use of ice particles which have the uniform grain size of ultra-fine water for cleaning the surface and grooves of the ferrite block (Tomoji, 1992) [24]. Ice blasting devise using stored particles was suggested by Harima (1992) [25]. S. Vissisouk (1994) [1] proposed to use ice particles near melting temperature in order to effectively remove coating. Meshher (1997) [26] suggested a nozzle for enhancement of the surface cleaning by ice blasting. Shinichi (1997) [27] suggested cleaning inexpensively various surfaces by mixing ice particles, cold water and air. Niechial (1998, 1998a) proposed an ice blasting cleaning system containing an ice crusher, a separator and a blasting gun. Settles (1998) [28] suggested producing ice particles of a size range below 100 micrometers within the apparatus just prior to the nozzle.

Although the use of ice blasting is suggested by a number of inventors, the practical application is much more limited. Herb and Vissaisouk (1996) [1] report the use of ice pellets for precision cleaning of zirconium alloys in the course of production of bimetallic tubing. It is reported that ice blasting improved the quality of bimetal. The use of air-ice blasting for steel derusting is reported by Liu et al (1998). The following operational conditions were maintained during blasting: air pressure: 0.2-0.76 MPa, grain diameter: below 2.5 mm, ice temperature 50C, traverse rate 90 mm/min, and standoff distance 50 mm. At these conditions the rate of derusting ranged from 290 mm²/min at the air pressure of 0.2 MPa to 1110 mm²/min at the air pressure of 0.76 MPa. The quality of the treated surface complied with ISO 8501-1 Sa 2.

We also investigated the application of ice-air jet (IAJ) for surface cleaning. The system in Figure 4.4 was used in these experiments. It was demonstrated that at the optimal range of process conditions this jet constitutes a precision tool for selective material removal operations. Number of experiments was carried out in order to demonstrate this ability of the air-ice jet. Various electronic devices (computers, calculators, electronic games and watches) were disassembled and electronic boards were contaminated by grease and metal powder. Then the boards were cleaned and reassembled. The computer, calculators and watches worked normally. Other experiments involved degreasing, depainting and deicing of liquid crystals, polished metals, optical glass, fabric, removal emulsion from a film, etc. Figure 8.1 and Figure 8.2.

The feasibility of the damage free and pollution free decontamination of highly sensitive surfaces was demonstrated.

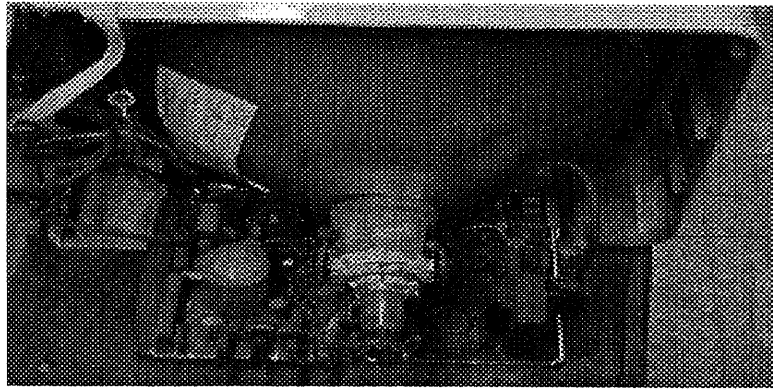

Figure 8.1 TV panel prior to the cleaning by the Ice Air Jet.

Because our system was designed to produce fine particles, it was not applicable for removal of heavy deposit, for example rust. Modification of the operational conditions, including the increase of the parts size, will address this problem. A generic environmentally friendly surface processing technology is emerging as the result of the above experiments.

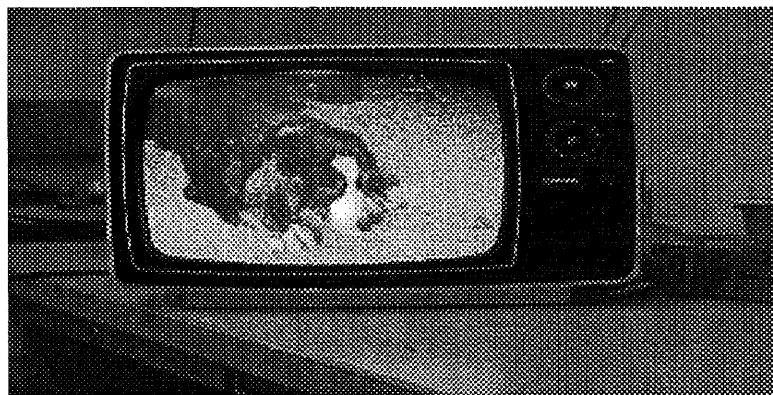

Figure 8.2 Image developed by TV after cleaning

APPENDIX C represents photographs of basic types of deposit and substrates, which were cleaned by Ice AirJet System.

CHAPTER 9

CRYOGENIC JETS

The use of liquid or solid carbon dioxide, nitrogen or ammonia as a machining or cleaning media has a number of advantages (Hashish and Dunsky, 1998) [4]. For these matters the only thermodynamically stable state at the normal conditions is gaseous state. Exiting the nozzle as a high-speed liquid stream the fluid is converted into the gas or gas-solid mixture. Because of this the liquid process residue is eliminated. In solid state these materials constitute vanishing abrasives. Because the fluid stream of these materials is maintained at very low temperature, the temperature of the impact zone is reduced to the level when the substrate material becomes brittle. The local brittleness of the substrate enhances material removal by the impinging jet. Due to the thermodynamic instability of the matter, the liquid stream, exiting the nozzle rapidly deteriorates. The rate of deterioration, and consequently the decrease of cutting power, can be predicted precisely. Thus these streams can be used for processing of fragile parts of complex geometry. The prediction of the effect of the distance on the jet momentum enables us to prevent material damage.

The potential applications of the cryogenic jets include (Dunsky and Hashish, 1996) [3] material processing in a highly hazardous environment, for example nuclear decontamination) and processing of highly hazardous materials for example, a nuclear fuel. Another extremal application involves processing in an extremely clean environment, such as aerospace vehicles, microelectronics and optical plants, etc. Other

potential applications include rescue operation (no damage of the substrate surrounding), jet assisted conventional machining (ductile-to-brittle conversion), etc.

Among the thermodynamically unstable fluids the most practical application found carbon dioxide. Conventionally CO_2 is contained in bottles at normal temperature of 298 K. The equilibrium temperature at this pressure is 67 bars Figure 9.1. At this conditions carbon dioxide exist as a saturated liquid.

At the nozzle exit the fluid pressure drops to 0.1 MPa. At this pressure the temperature of the carbon dioxide drops to 195 K and the liquid is converted into the mixture of the gas and the solid.

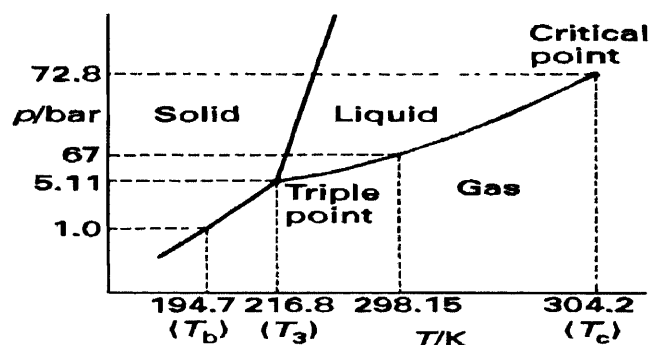

Figure 9.1 State diagram of carbon dioxide. (Sherman and Adams, 1996)

This mixture is used as a cleaning media. Impacting the surface solid particles separate a deposit, while the gas flash the separated deposit away (Sherman and Adams, 1996) [5]. A blasting gun at Figure 9.2 is used for this cleaning. If the time interval between the fluid exit from the nozzle and the jet impact less than the time needed for the conversion of liquid into gas-solid mixture, carbon dioxide impacts a substrate as a liquid (Hashish and Dunskey, 1998) [4]. In this case the mechanical action of the jet is supplemented by deposit dissolving by the impacting liquid. Solid dry ice particles can

also be used as a conventional abrasive and can be driven by a fluid similarly to regular abrasive particles (Hitoshi, 1996) [21].

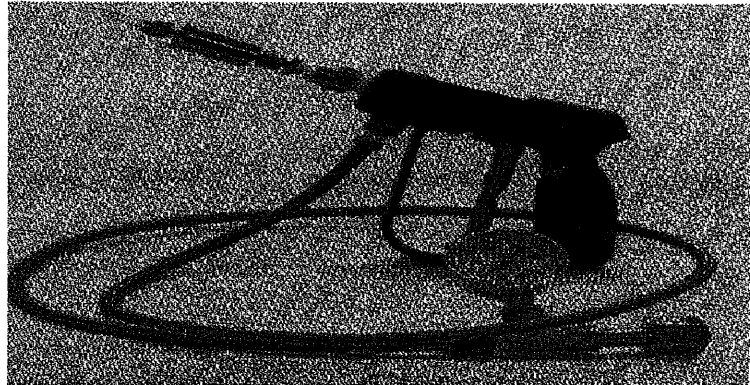

Figure 9.2 Gun for blasting carbon dioxide. (Sherman and Adams, 1996)

Hashish and Dunsky (1998) [4] studied the use of liquid nitrogen as a machining media. The study showed that if the intensive vaporization occurs in the course of the jet development (upstream the nozzle temperature of 161 K, pressure of 55 MPa) the cutting power of the fluid is severely diminished. If however, the upstream temperature is reduced to 86 K the vaporization of the is liquid is suppressed, jet coherence is maintained and the jet constitutes an effective machining tool. Liquid nitrogen can be used for acceleration of abrasive particles (Dunsky and Hashish, 1996) [3]. The schematic of such application is shown in Figure 9.3. A cryogenic pump is fed from the tank and supplied the fluid into the abrasive nozzle head. The nozzle is guided by a robotics arm. Although process was similar to the conventional AWJ machining, several specific problems determined by the low process temperature were observed. Atmospheric air used to drive the abrasive to the nozzle contained moisture. The

condensing of the moisture in a mixing chamber interrupted abrasive flow. Because of this the abrasives were located in the nitrogen atmosphere. Another problem was related to the dissipation of the jet energy in the catcher. Without a water environment the catcher did not operate satisfactory.

The impact of liquid ammonia combines mechanical and chemical effects. Because of the liquid ammonia jets can be effectively used for removal of explosive materials. Melvin (1993, 1994) [22,23] suggested the technology for the extraction and recovery of solid propellant by ammonia jets

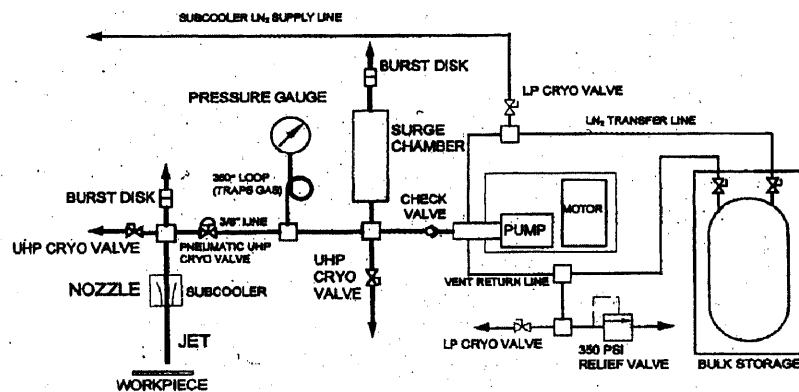

Figure 9.3 Schematic of Ultra High Pressure LN₂ Jet experiment.

CHAPTER 10

DEVELOPMENT OF USERFRIENDLY GREEN CLEANING SYSTEM

Recently, chemical treatment constituted the major derusting technique. Chemical cleaning is an effective and competitive surface processing technology. However the environmental legislation and public awareness limited the use of this technology. A number of various alternative processes were explored in order to replace chemical cleaning by an environmentally acceptable surface processing technology. The practice demonstrated that the most realistic replacement of the chemical treatment is water blasting. It was found that in the most cases jet cleaning not only meets technical specification, but also in a number of cases is the most effective technology. However, significant deficiencies impede adoption of the water blasting. The water consumption for decoating is comparatively high. The disposal of this water is environmentally damaging, while water recycling is comparatively expensive. Water impact might cause the substrate damage, while insufficient water velocity results in low productivity. The specialized facilities are needed for waterjet cleaning, etc.

The addition of abrasives into the waterjet (WJ), that is formation of the abrasive waterjet (AWJ), dramatically improves process productivity. This, however, results in the potential contamination of the substrate as well as in the generation of the difficult to deal with emission. The pollution will be eliminated if a benign abrasive material, for example water ice, is used to enhance material removal. The replacement of the abrasive waterjet by the mixture of water and water ice will combine competitive process productivity with its green nature.

Icejet (IJ) is a slurry flow similar to abrasive waterjet. IJ combines the positive features of WJ and AWJ. Similarly to AWJ, the icejet is, in principle, able to machine various materials, such as metals, ceramics, glass. Similarly to WJ the icejet does not contaminate impingement site by abrasive materials and does not generate off-stream except for debris and water. In fact, IJ constitutes the only available tool able to carry out material machining free of contamination by any foreign matter except for water. The green nature of this technology constitutes its advantage and, thus, commercial importance of IJ. For example, it determines the potential for IJ application in food and semiconductor industries, in medicine and surface decontamination.

The hardness of ice particles is less than that of abrasive particles used in a conventional AWJ. Thus the expected productivity of IJ is less than the productivity of AWJ. Nonetheless, the feasibility to shape contamination sensitive materials and termination of the negative environmental effects make this loss of productivity quite acceptable. The principle shortcoming of IJ machining, however, is the difficulties of generation and handling of ice particles. In order to assure the adoption of IJ by the industry, it is necessary to develop a practical technology for formation of the ice-water slurry.

There are several possible techniques for IJ formation. Ice particles can be produced separately and then injected into the water stream similarly to abrasive particles. Thus, at least in principle, we can generate ice particles of the desired dimensions, having maximal hardness. The obvious shortcoming of this technology is the need for auxiliary systems for production and transportation of ice particles. More important deficiency is the necessity of the use of the focusing tube for the formation of

the slurry flow. The minimal diameter of the focusing tube, that is the minimal diameter of the stream, exceeds 350 micron.

IJ can be created by the formation of the ice particles in the course of jet expansion in the nozzle. Thermodynamics of ice (Hobbs, 1974) [8] allows us to reduce the temperature of the compressed water much below 0 C without freezing. At the pressure of 2,000 psi water temperature can be reduced down to - 25 C. During the expansion in the nozzle, while water pressure reaches 1 bar part of water is converted into ice. Due to enthalpy release during the solidification water temperature increases, but it cannot exceed 0 C. The fraction of water converted into ice is determined by the difference between water enthalpies prior and after the nozzle and by the enthalpy conversion into kinetic energy of the stream during water acceleration. The shortcomings of this technology are the difficulties of the control of particle nucleation and growth and, the most of all, a small margin of enthalpy available for the solidification.

Finally, ice formation is possible by cooling compressed water prior to the nozzle and additional water cooling in the focusing tube. Heat removal in the focusing tube can be attained, for example, by the submerging the focusing tube into a cooling media. This technique enables us to increase the rate of the ice generation, but results in the increase of IJ diameter due to the use of the focusing tube. However, in this case the focusing tube is not used for mixing water and particles, because of this the diameter of the focusing tube and thus stream diameter are significantly less than those during particles addition. Cooling of the focusing tube requires much simpler facility than preparation and handling of ice particles. Thus, each of the above technologies has its shortcomings and benefits

and further experiments are required to specify the areas of applications of each technology.

Previous studies of IJ machining reported by Galecki and Vickers (1982) and Truchot et al (1992) involved the examination of stream freezing and ice particles supply in the water stream. It was reported by these authors that addition of ice particles into WJ improves cutting of soft materials, that is the materials that can be cut by a conventional WJ. The study of the formation and the use of the IJ has been carried by Waterjet Technology laboratory of NJIT since 1993. (Geskin et al, 1995, 1995a, 1996, 1997, 1997a, 1999, Li at al, 1995, 1996) [14-21]. Two systems for particles generation were constructed and integrated into the waterjet machining equipment. The first system involved particles formation at a separate units and subsequent supply into a port for abrasive delivery. The second system involved particle formation by the partial freezing of the water stream exiting from the nozzle. The developed IJ was used for cutting and drilling of various metals (titanium, stainless steel, and aluminum). The same samples were cut by the waterjet (WJ) and (AWJ) in order to compare these three technologies. Performed research evidently demonstrated feasibility of material machining using both modes of IJ formation. However, formation and entrainment of ice particles should be improved in order to replace conventional abrasive materials by ice.

In the course of our previous research several systems for the generation and supply of ice powder were tested. However, due to clogging of the ice particle the operation of these system was unstable. It was found that ice particle agglomerate at different stages of production and transportation. Particularly, ice particles tend to agglomerate if they are stored even for a short time. To prevent this phenomenon it is

necessary to control flow rate of the powder during the ice motion and to prevent ice accumulation at any site. The maintaining the surrounding of the system for powder production and transportation at subzero temperature did not prevent clogging. The presence of the moisture in the surrounding atmosphere almost instantaneously brings about particle agglomeration. It was found that it is necessary to maintain ice temperature below -25 C to assure continuous ice flow.

The most frequent site of the ice agglomeration was the port of the particle entrance in the mixing chamber. Analysis of the conditions of the heat exchange in this chamber showed that the phenomena in question are due to the solidification of the water vapor at the entrance into the mixing chamber. Due to the water vaporization in the course of isoenthalpic decompression in the orifice the vapor density in the atmosphere of the chamber is high. The contact between the wet air in the chamber and the entering cold air results in the ice formation at the port of the air-powder entrance. Formation of the ice lumps within the air-ice flow resulted in the clogging of the supply line. Heating of the area around the entrance in the nozzle head eliminated the problem above.

Control of particle entrainment by the water stream is also a crucial stage of IJ formation. FIDAP modeling showed that duration of particle residence in the mixing chamber prior to the entrainment by the water stream is significant. In fact formation of the slurry jet involves accumulation of particles in the mixing chamber. This bears minimal if any consequences in the course of formation of abrasive water jet. However long residence time of ice particles results in particles melting. Thus it is necessary to maintain a low temperature in the mixing chamber as well as to minimize the dwell time.

There are no reports on the practical use of the water-ice slurry. Our experiments show that prevention of ice melting and better control of particles properties will assure reliable system operation and bring about the adoption of IJ by the practice.

The use of the ice particles is simplified if the particles are entrained in the air stream. There is a number of suggested air-ice based technologies. One of the firsts of such suggestions is a car washing machine, utilizing ice particles (US Patent 1955). The stream of the charged frozen particles precisely controlled by a set of coils was directed at treated surfaces (Kanno et al, 1991). Szijcs (1991) proposed cleaning of the sensitive surfaces by the impact of the fine grade blast material and air. The blast material is formed by the atomization of the liquid in the air stream and subsequent freezing of the generated fine droplets. The freezing occurs by the addition of the refrigerant (N₂, CO₂, Freon) into the stream. in the mixing chamber or by the addition of refrigerant into the jet after the mixing chamber. The use of ice particles which have the uniform grain size of ultrafine water for cleaning the surface and grooves of the ferrite block (Tomoji,1992) [20]. Ice blasting devise using stored particles was suggested by Harima (1992). S. Vissisouk (1994) [1] suggested to use ice particles near melting temperature in order to effectively remove coating. A nozzle for enhancement of the surface cleaning by ice blasting was suggested by Meshner (1997) [26]. Shinichi (1997) [27] suggested to clean inexpensively various surfaces by mixing ice particles, cold water and air. Niechial (1998, 1998a) proposed an ice blasting cleaning system containing an ice crusher, a separator and a blasting gun. Settles (1998) [28] suggested to produce ice particles of a size range below 100 micrometers within the apparatus just prior to the nozzle.

Although the use of ice blasting is suggested by a number of inventors, the practical application is much more limited. Herb and Vissaisouk (1996) [1] report the use of ice pellets for precision cleaning of zirconium alloys in the course of production of bimetallic tubing. It is reported that ice blasting improved the quality of bimetal. The use of air-ice blasting for steel derusting is reported by Liu et al (1998) [2]. The following operational conditions were maintained during blasting: air pressure: 0.2-0.76 MPa, grain diameter: below 2.5 mm, ice temperature: -50°C, traverse rate: 90 mm/min, standoff distance: 50 mm. At these conditions the rate of derusting ranged from 290 mm²/min at the air pressure of 0.2 MPa to 1110 mm²/min at the air pressure of 0.76 MPa. The quality of the treated surface complied with ISO 8501-1 Sa 2. The presented work demonstrates the feasibility of metal derusting by air-ice mixture if adequate process conditions are selected.

We also investigated the application of ice-air jet for surface cleaning. It was demonstrated that at the optimal range of process conditions this jet constitutes a precision tool for selective material removal operations. Number of experiments was carried out in order to demonstrate this ability of the air-ice jet. Various electronic devices (computers, calculators, electronic games and watches) were disassembled and electronic boards were contaminated by grease and metal powder. Then the boards were cleaned and reassembled. The computer, calculators and watches worked normally. Other experiments involved degreasing, depainting and deicing of liquid crystals, polished metals, optical glass, fabric, removal emulsion from a film, etc. The feasibility of the damage free and pollution free decontamination of highly sensitive surfaces was demonstrated. Because our system was designed to produce fine particles, it was not

applicable for removal of heavy deposit, for example rust. Modification of the operational conditions, including the increase of the particle size, will address this problem. A generic environmentally friendly surface processing technology is emerging as the result of the above experiments.

CHAPTER 11

FUTURE WORK

The following experimental techniques will be used for the system development:

Investigation of the Rust Removal: Various rusted parts of car bodies will be treated by the air-ice and water-ice streams at a wide variety of operational conditions. At the initial stages of the study existing ice blasting facilities will be used to investigate ice based derusting. Then a laboratory scale prototype of the derusting system will be constructed and used for process examination. After processing a surface in question will be investigated in order to determine the completion of the rust removal and induced surface damage. Optical and scanning electron microscopes will be used to evaluate completion of the rust removal. SEM examination will also determine the contamination of metal surface by various oxides. This examination will be carried out immediately after derusting, in order to evaluate the completeness of the rust removal and in 2-3 months in order to determine regeneration of the rust. Surface profilometer and the three-dimensional surface analyzer will be used to determine the modification of the surface topography by the impinging streams.

Investigation of the Water Freezing: We will examine existing commercial and experimental icemakers and determine practical water freezing technologies. Then the experimental study of ice formation will be carried out. Various batch and continuous heat exchangers will be constructed and the rate of water freezing as well as ice sticking

to the solid parts of the freezer will be examined. The temperature of the water and flow rate of the cooling media will be monitored. The optimal design of the heat exchanger will be determined.

Investigation of the Ice Grinding: The various knives will be used to generate ice particles. The microscopic evaluation will determine the size and the form of the generated particles.

Investigation of the Air-Ice Jet Formation: Various converging and converging-diverging nozzles will be used to form ice-air stream. The effectiveness of the stream will be estimated by the rate of the rust removal and by the velocity and distribution of the ice particles. The (PIV) will be used for the measurement of particles velocity.

The following theoretical techniques will be used in this study:

Fuzzy Logic Modeling of Rust Removal: A routine fuzzy logic procedure will enable us to evaluate correlation between input variables and the rate of the derusting. This technique will account for the state of the surface and the degree of the rust removal. The procedure, which will be used in this study, was developed earlier in the Waterjet Laboratory and applied to modeling of the steel depainting (Babets and Geskin, 1999).

Modeling of the Water Freezing: The mathematical model of the water solidification will be constructed. A commercial package for solving of the developed equations will be identified and used to examine the dynamics of freezing.

Mathematical Modeling of Jet Formation: A routine procedure for investigation of the air acceleration in cylindrical, converging and converging-diverging nozzle will be used to investigate air acceleration.

Mathematical Modeling of the Air-Particles Mixing: FIDAP package will be used to examine the entrainment of the ice particles by the airflow in the mixing chamber.

CHAPTER 12

CONCLUSION AND RECOMENDATIONS

The performed experiments evidently demonstrated feasibility of the use of ice particles as an abrasive material. IJ was able to machine all tested materials, including composites, titanium and steel. Process productivity was comparatively low, but it will be dramatically improved by the optimization of the particles size and temperature as well as mechanism for particles supply. Obtained results shows the feasibility of the use of IJ for machining of clean materials when AWJ is not applicable as well as for replacement of AWJ in order to meet environmental and economical concerns.

The feasibility of the use of ice particles as a pollution free machining tool was demonstrated. Several applications of the ice-air jet for material processing, parts reclamation and reengineering and equipment maintenance are emerging. The emerging technology includes precision cleaning of highly delicate and complex mechanical, electronic and biomedical components. A low cost of ice-air cleaning will enable us to use it for processing large surfaces at a high rate. On-line degreasing of metal in the course of rolling or prior to machining illustrates this application. Still another application involves cleaning of sensitive facilities such as lining of pharmaceutical or food processing reactors, aircraft skin, etc. Cleaning of discarded parts for reuse or recycling constitutes another potential application. Icejet will also be used as an etching tool for surface preparation during material deposition, precision decoating, chips fabrication, etc. A generic environmentally friendly surface processing technology is emerging as the result of the presented study.

As the result of performed study we recommend to complete design of practical reliable system for ice production. Our study showed that optimal design would integrate water freezing and particles formation. We do not recommend at this point to continue work on the design of a system involving partial water pressure in the course of jet formation. More information about the thermodynamics of water decompression combined with water transformation is needed. However we do recommend enhancing the study of thermodynamics of this phenomena. We do recommend to concentrate available resources on the investigation of IJ and development system for its formation. Our research demonstrated that Ice Air Jet would become a major tool for processing of very sensitive surfaces in electronics, precision machining, optics, medicine, etc. A number of examples presented in APPENDIX D show efficiency of the use of this jet.

APPENDIX A

LABORATORY SCALE PROTOTYPE OF ICEJET FORMATION

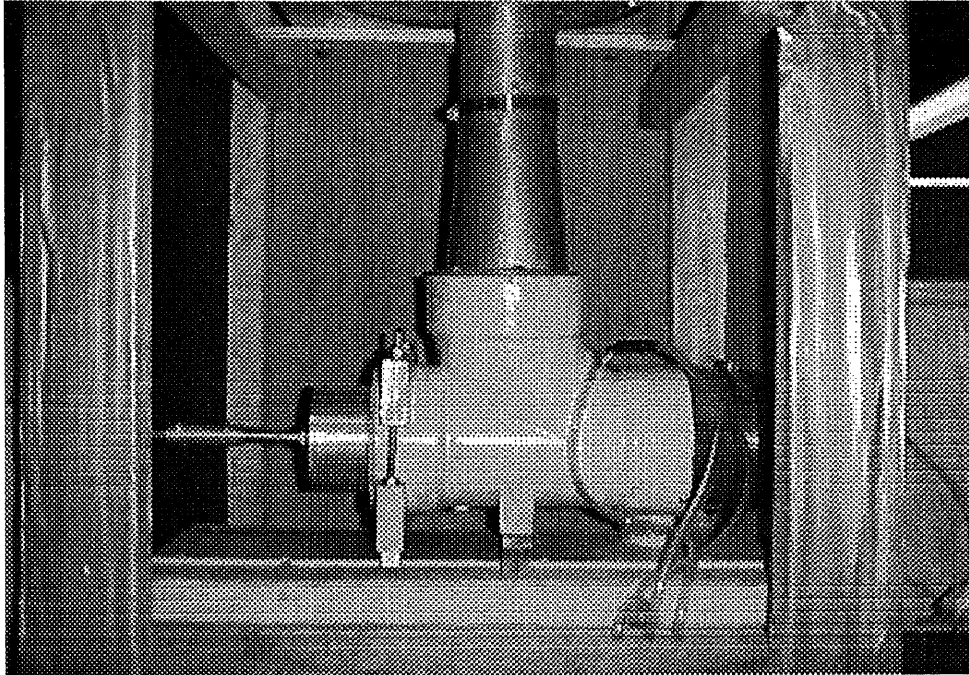

(a)

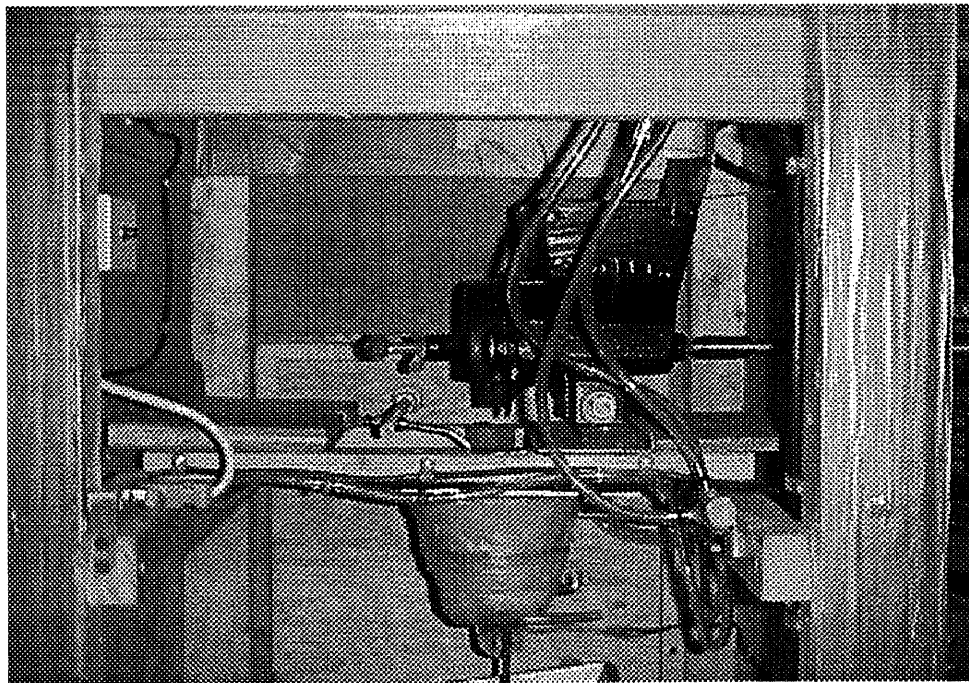

(b)

Figure A.1 (a) Photograph of the first stage of crushing (average diameter of ice particles $5.0 \text{ mm} < D_1 < 10.0 \text{ mm}$), and (b) photograph of the second stage of crushing (average diameter of ice particles $1.0 \text{ mm} < D_2 < 3.0 \text{ mm}$)

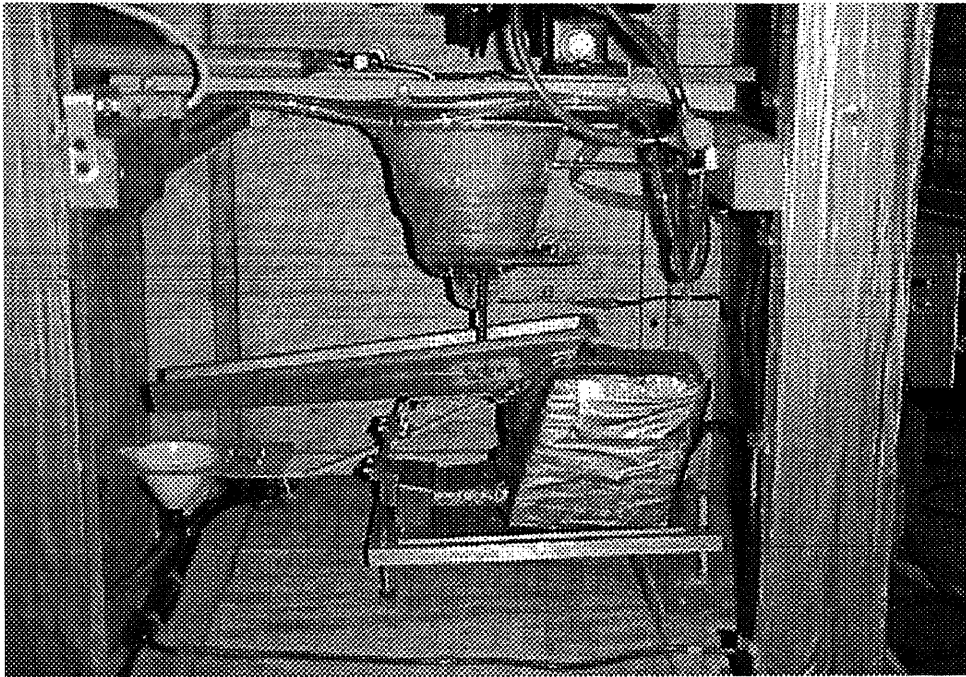

(a)

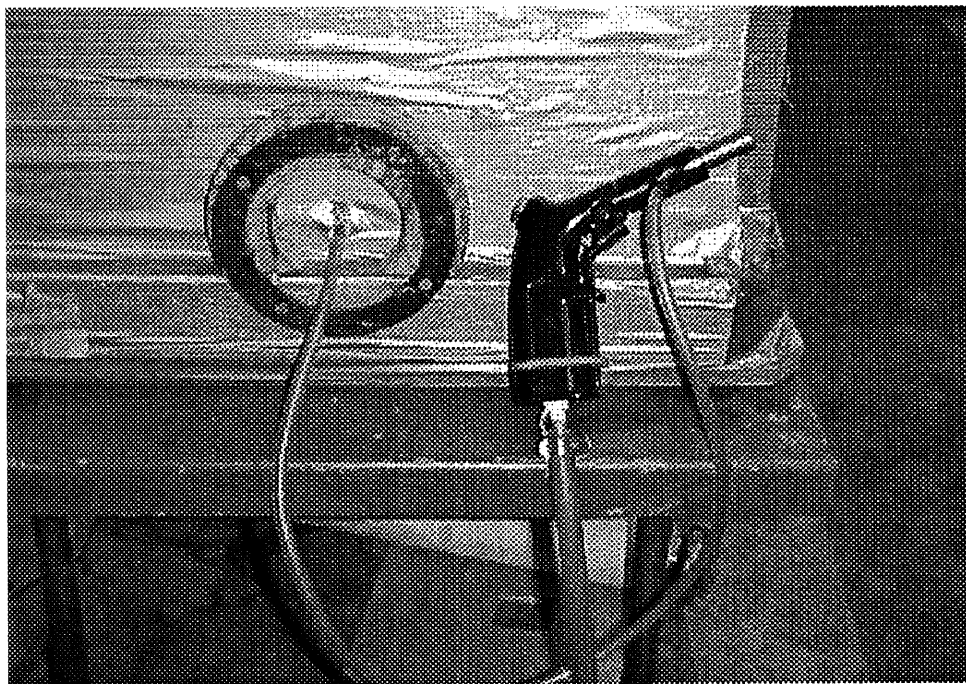

(b)

Figure A.2 (a) Photograph of the intermediate supply bunker 1 and the electromagnetic vibrator, and (b) photograph of the air gun with high pressure air supply line and intermediate supply line.

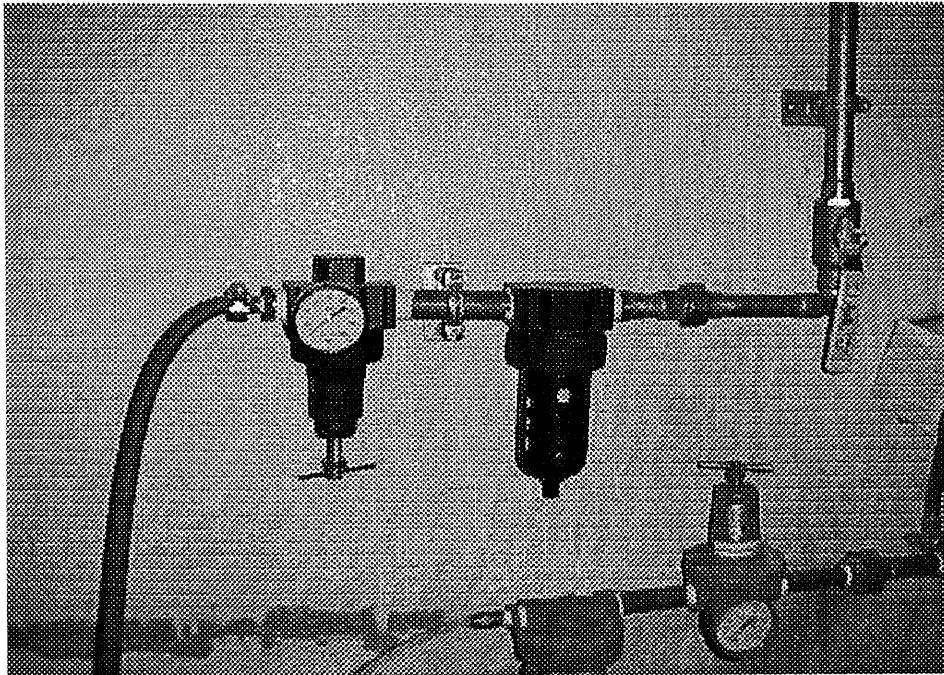

(a)

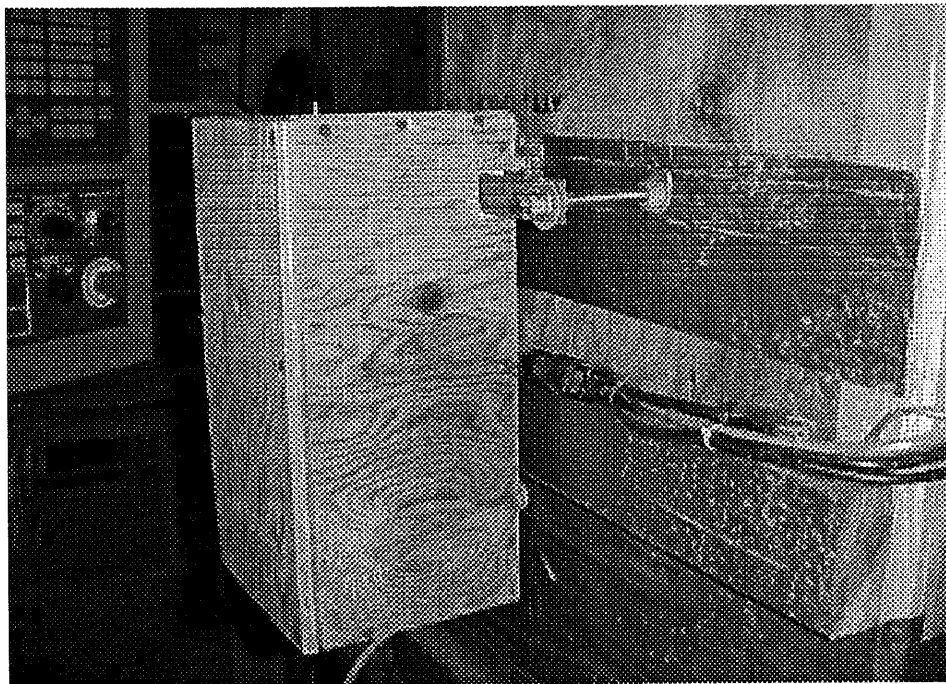

(b)

Figure A.3 (a) Photograph of the high pressure air supply port, and (b) photograph of external adjustable force and speed vibrator (115 V, single phase, 3600 vpm, 70 dB)

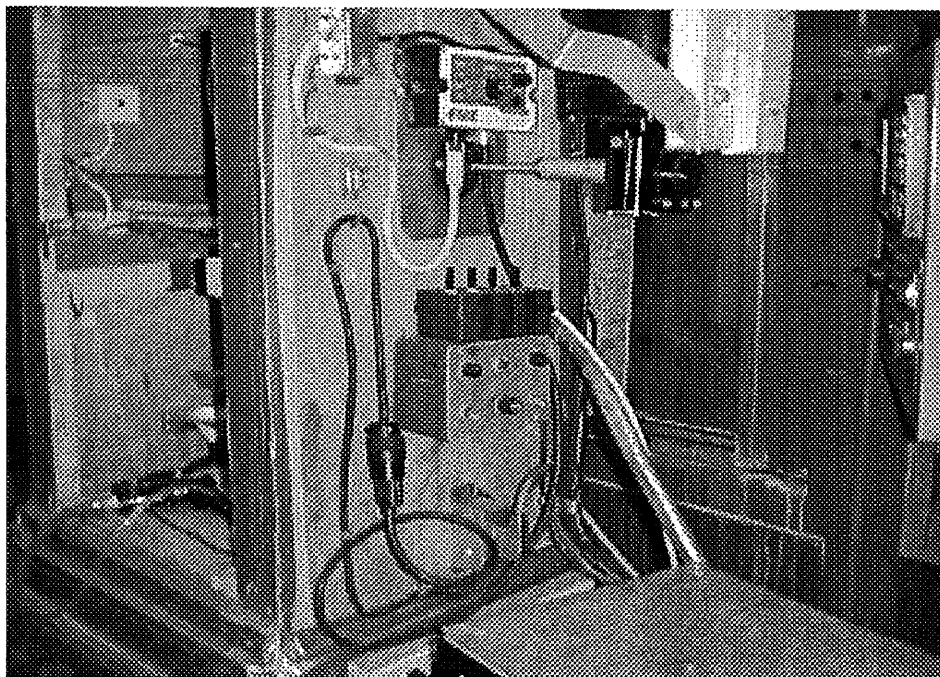

(a)

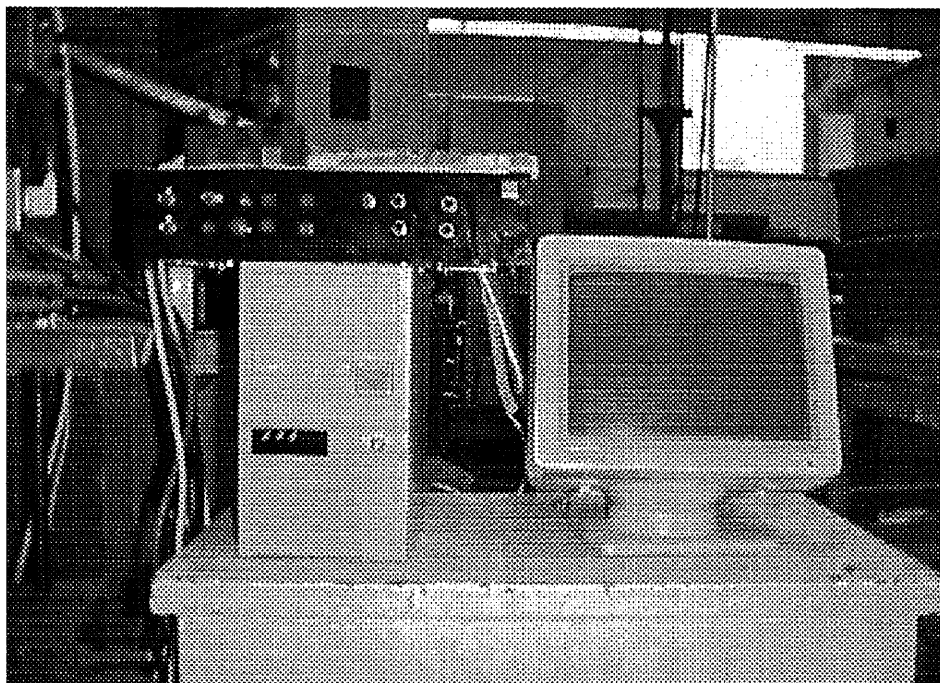

(b)

Figure A.4 (a) Photograph of the control panel, and (b) photograph of the automatic control system connected to PC.

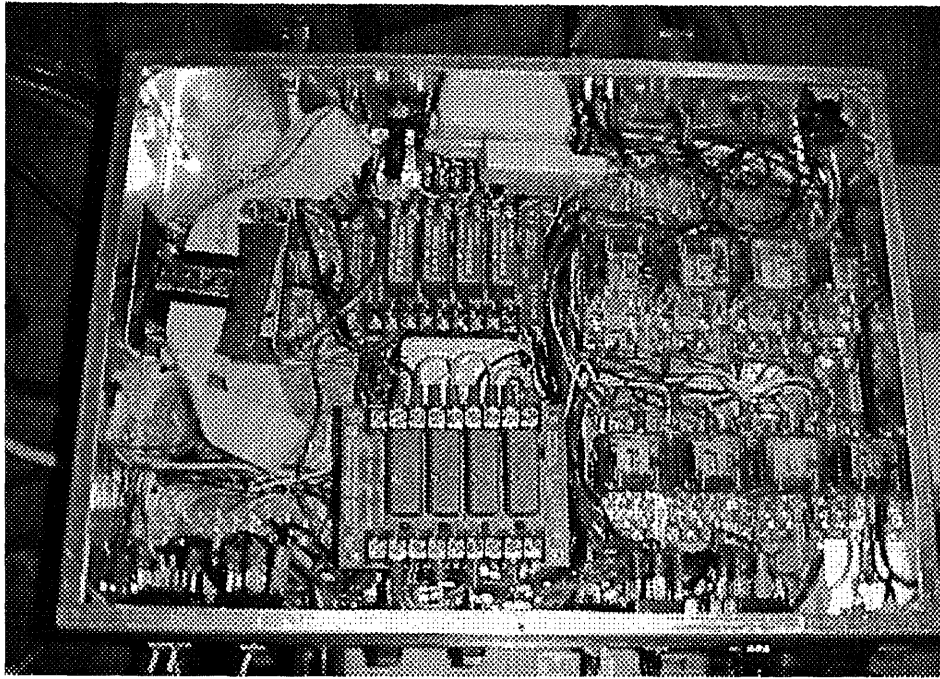

(a)

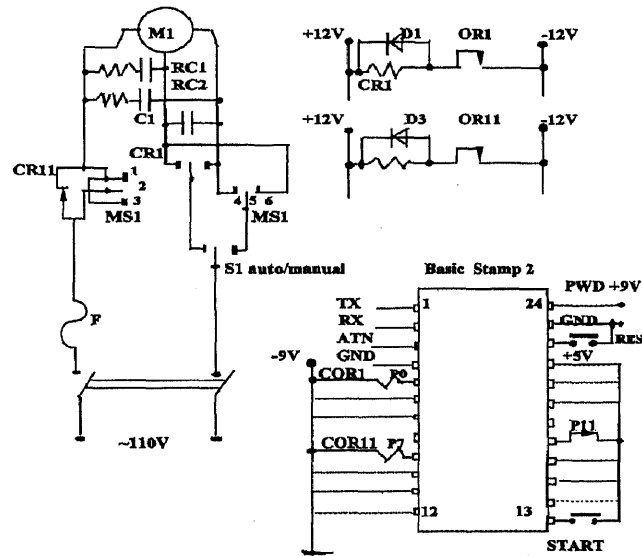

M	ACMotor
CR	Relay 1A484
S	Toggle Switch DPDT
COR	Optical Relay ODC - 5
MS	Momentary Switch
LS	Limit Switch(magnetic switch)
Stamp	Microcontroller (Parallax, Inc.)
D	Diode 3A 250V
RC	Contact Suppressor 0.1E-6,120 Ohm
F	Fuse 4XH54

(b)

Figure A.5 (a) Photograph of the schematic of automatic control system, and (b) electrical schematic of the automatic control system.

```
START :  
DEBUG " START LOOP "  
LOW 1:LOW 2:LOW 3:LOW 4:LOW 5:LOW 6:LOW 7:LOW 8:LOW 9:LOW 10:  
LOW 11:  
INPUT 8  
LOW 8  
IF IN 8=1 THEN RUN  
B0=0:B1=0:WO=0:  
GOTO START  
RUN: DEBUG " SYSTEM WORKING "  
FOR B0=0 TO 99  
  DEBUG ? B0  
  HIGH 7:HIGH 3  
  PAUSE 60000  
  LOW 7:LOW 3  
  DEBUG " VIBRATOR IS WORKING "  
  SLEEP 1  
NEXT  
STOP
```

Figure A.6 Example of the program written in programming language for CPU Basic Stamp II.

APPENDIX B

FIDAP MODELING OF PARTICLES MOTION

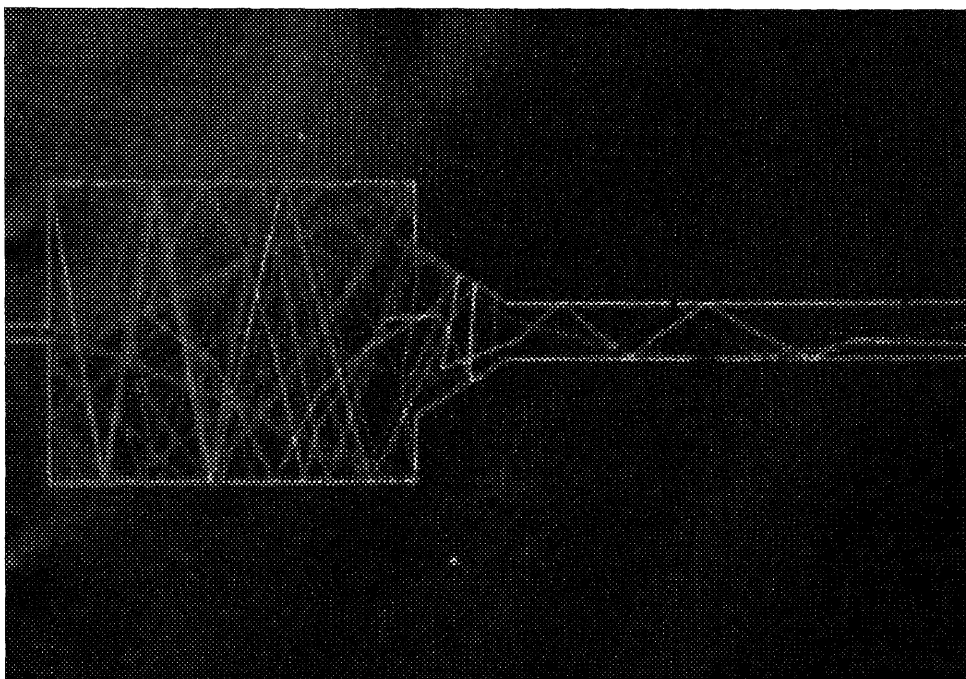

(a)

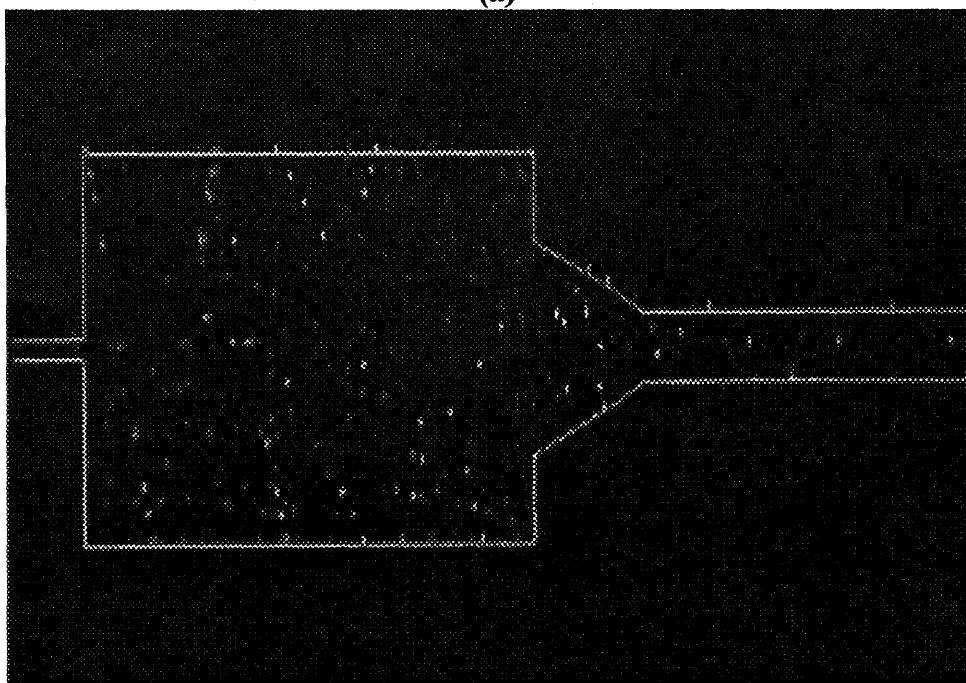

(b)

Figure B.1 (a) Monitoring of particles trajectory in the coarse of formation of the Ice Water Jet. Notice the duration of particles residence in the mixing chamber. In the case of formation of IceJet this results in melting and disappearance of ice particles, and (b) particles distribution in the mixing chamber and focusing tube. Excessive residence time in the mixing chamber brings about disappearance of ice particles.

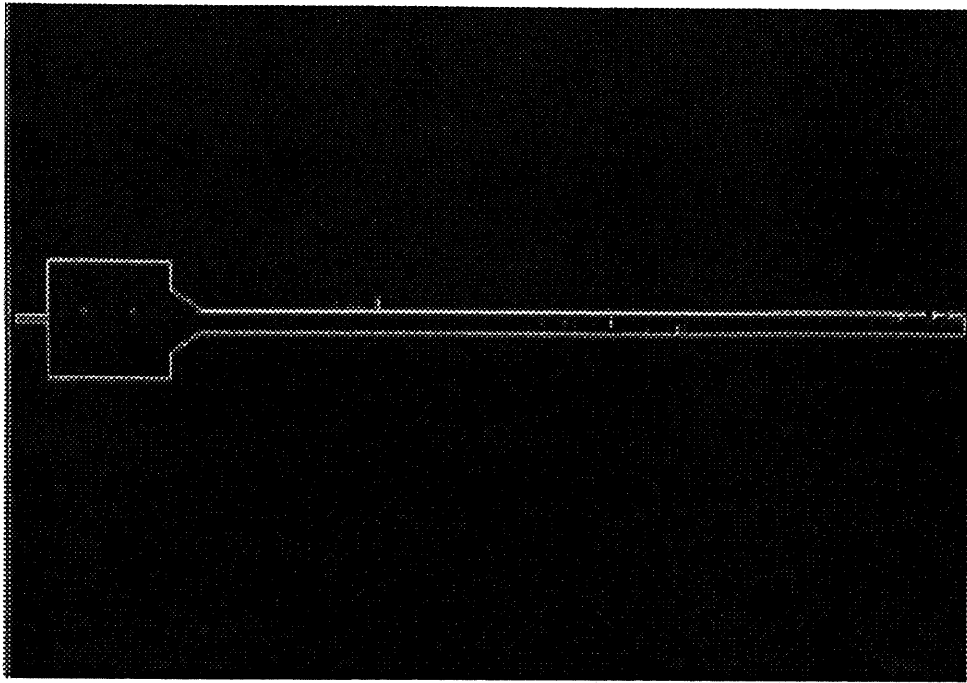

(a)

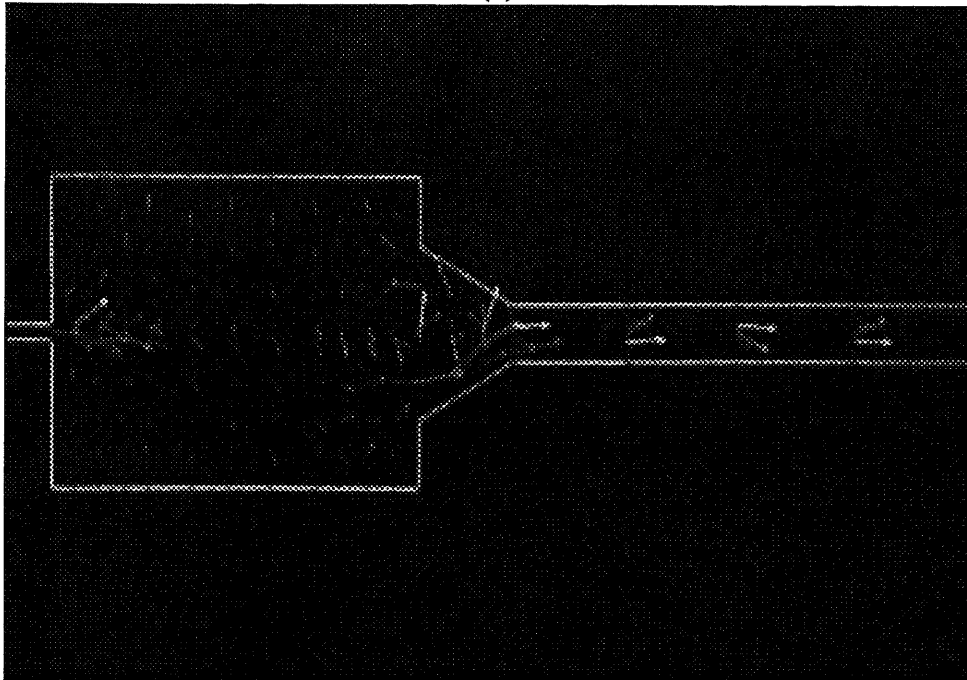

(b)

Figure B.2 (a) Particles distribution within the water flow in the case of axial particles supply. Notice short particles residence time in the mixing chamber. This mode of particles supply is effective for IceJet Formation, and (b) distribution of water velocity in the course of IceJet Formation. Notice high particles velocity in the entrance of focusing tube. In the case of collision this velocity brings about particles disintegration.

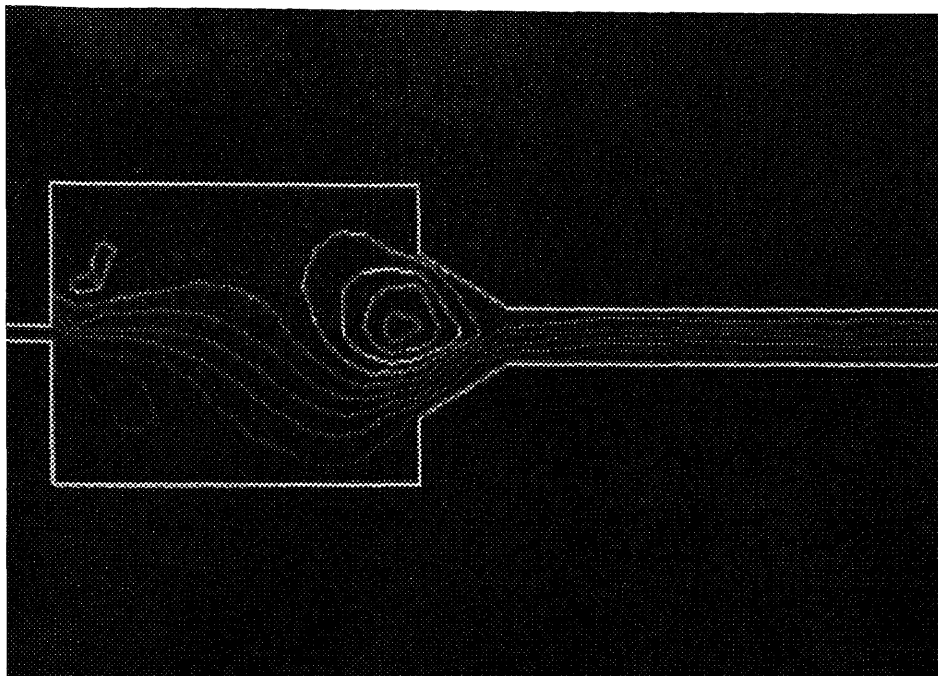

Figure B.3 Pattern of water flow in the course of IceJet Formation. Notice intensive water circulation at the entrance of the focusing tube. This results in melting and disappearance of ice particles.

APPENDIX C

PHOTOGRAPHS OF SAMPLES OF WATER JET AND ICEJET CUTTING

SET OF EXPERIMENT PARAMETERS

Water Pressure : 340.0 MPa (50,000 Psi)

Stand Off Distance : 2.5 mm

Diameter of Sapphire : 250 micron

Diameter of Focusing Tube : 1100 micron

Speed of WJ and AWJ Cutting : 25 cm / min

Speed of IJ Cutting : 5cm / min

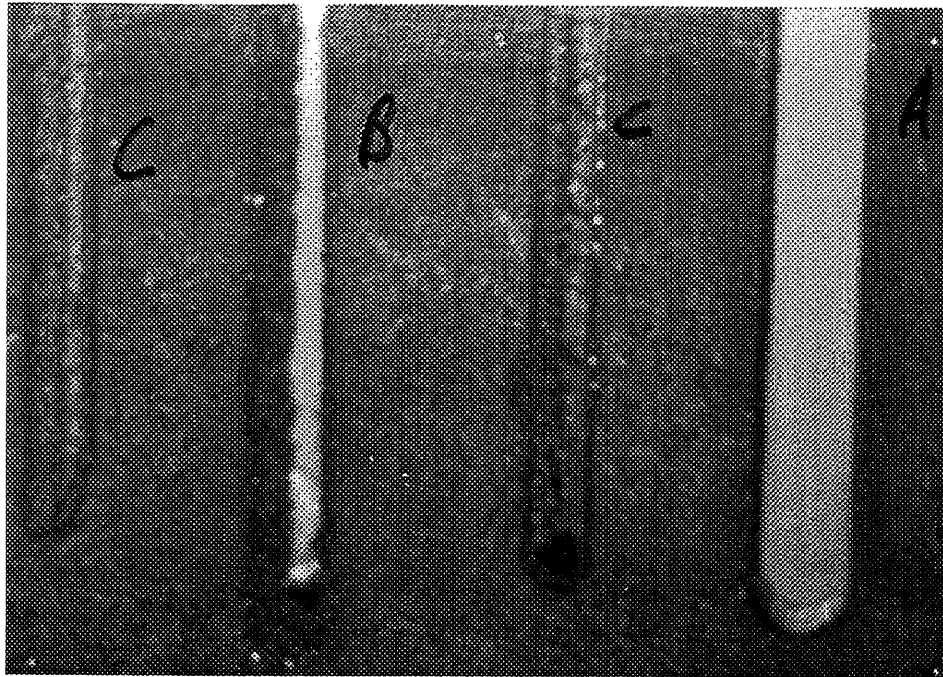

(a)

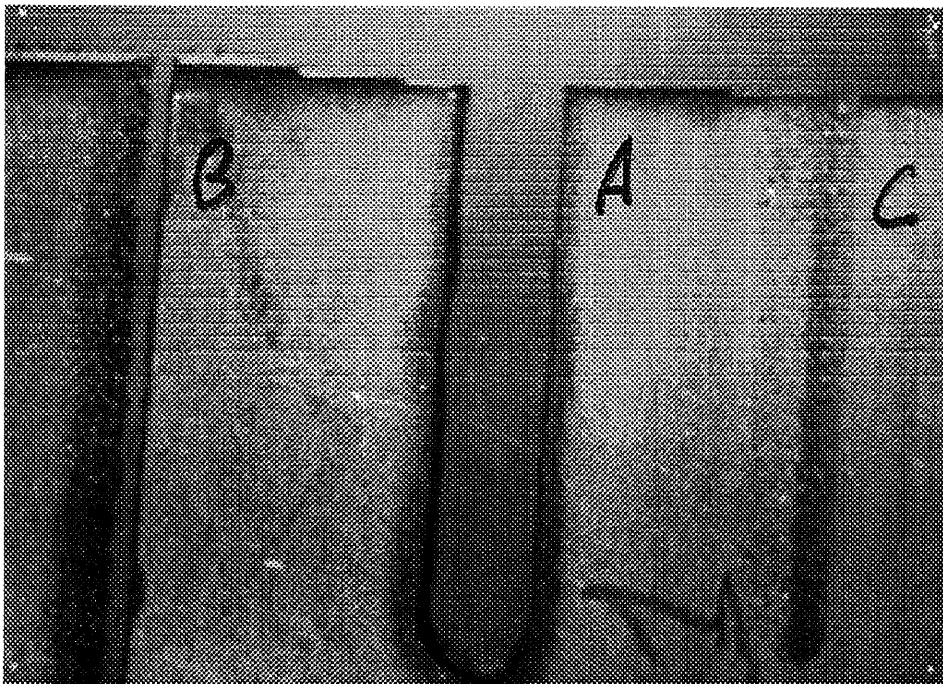

(b)

Figure C.1 Photographs of (a) cutting of copper strip of thickness 1.7 mm (X65) Notice reduced width of kerf in the course of IJ cutting . Notice intensive erosion of the substrate surface in the vicinity of IJ generated kerf, and (b) cutting of stainless steel strip of thickness 0.7 mm (X65). Notice superior machining ability of IJ comparative to WJ. Notice reduced width of the kerf generated by IJ.
 A – Abrasive Waterjet ; B – IceJet ; C – WaterJet .

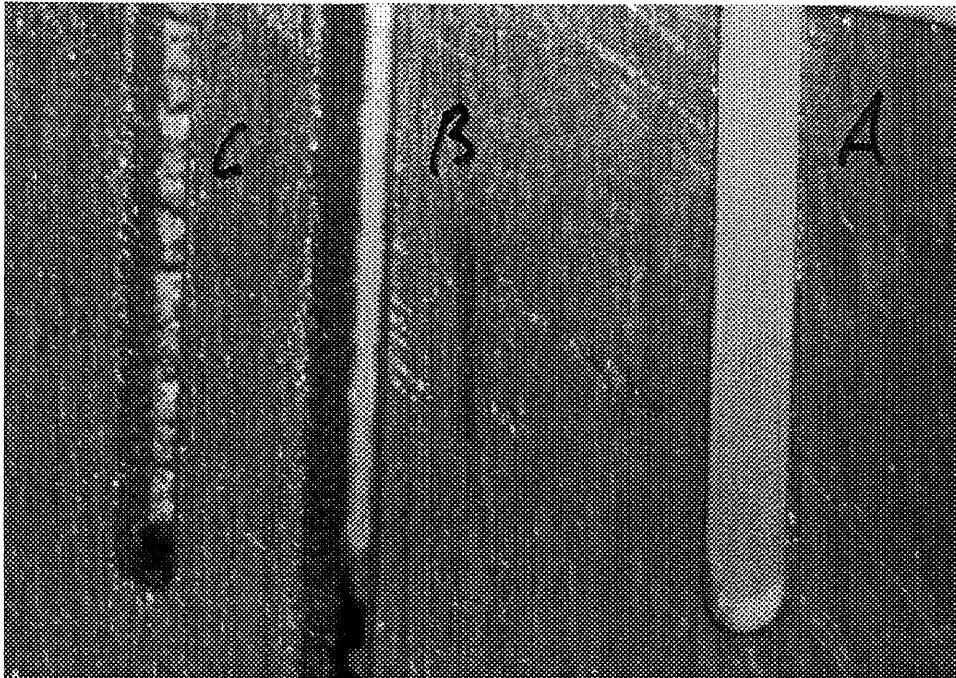

(a)

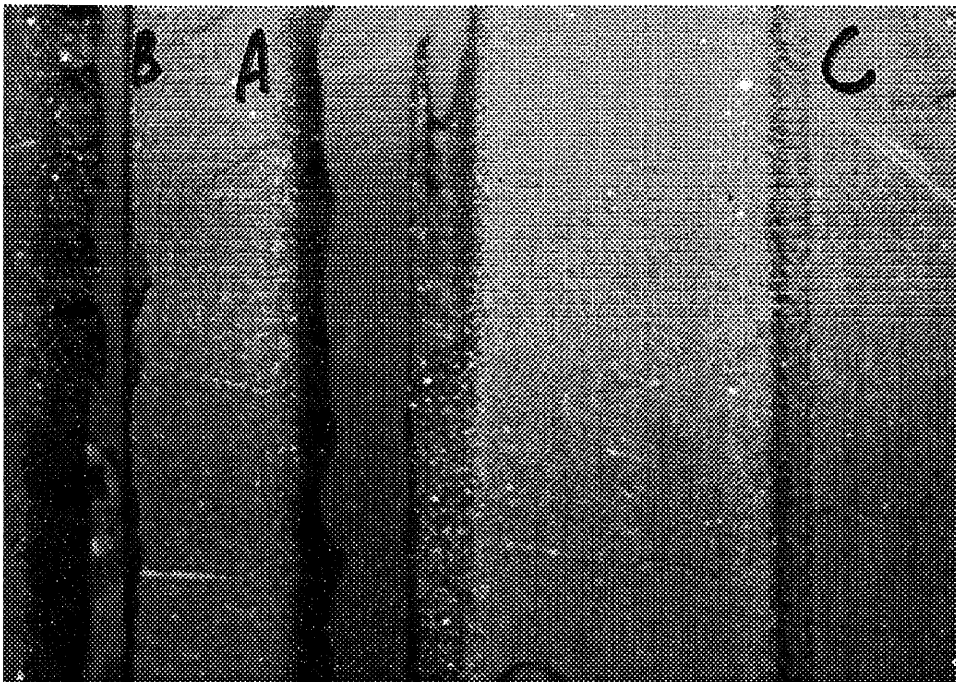

(b)

Figure C.2 Photographs of (a) cutting of aluminum strip of thickness 3.1 mm (X65). Notice reduced width of the kerf generated by IJ. Notice substrate surface erosion in the vicinity of IJ generated kerf, and (b) cutting of stainless steel strip of thickness 1.3 mm (X65). Notice superior machining ability of IJ comparative to WJ. Notice reduced width of the kerf generated by IJ.

A – Abrasive Waterjet ; B – IceJet ; C – WaterJet .

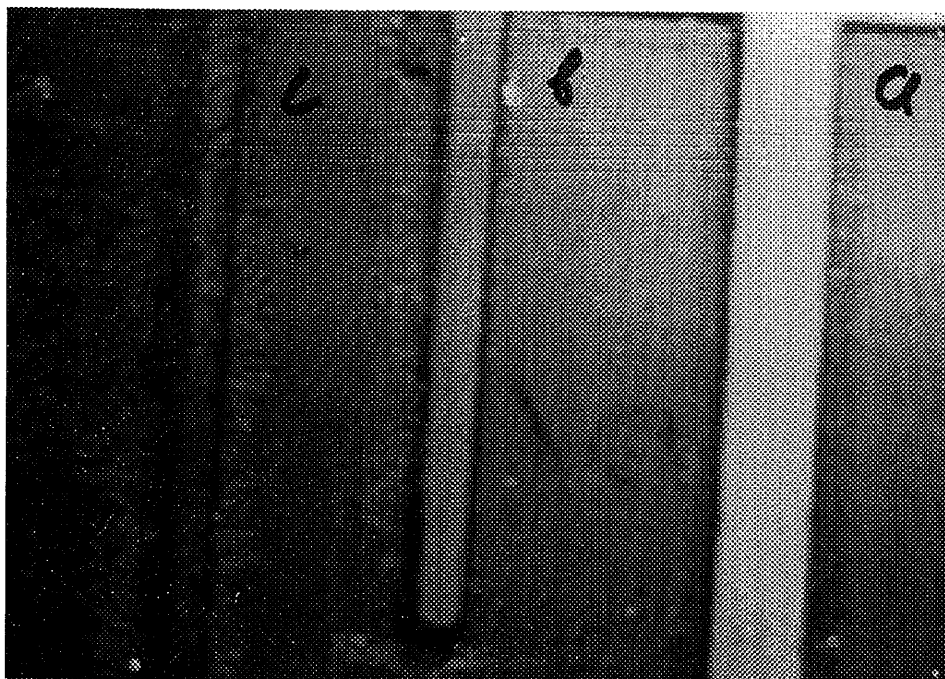

(a)

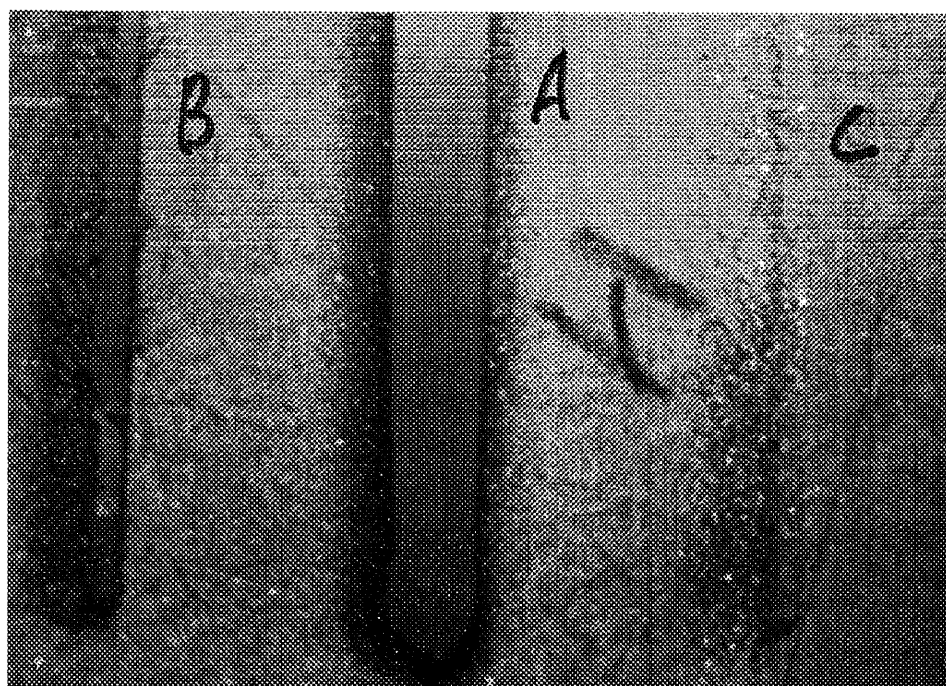

(b)

Figure C.3 Photographs of (a) cutting of carbon steel strip of thickness 0.7 mm (X65). Notice reduced width of kerf in the course of IJ cutting. Notice intensive erosion of the substrate surface in the vicinity of IJ generated kerf, and (b) cutting of titanium sample of thickness 0.7 mm (X65). Notice reduced width of kerf in the course of IJ cutting. Notice intensive erosion of the substrate surface in the vicinity of IJ generated kerf. A – Abrasive Waterjet ; B – IceJet ; C – WaterJet .

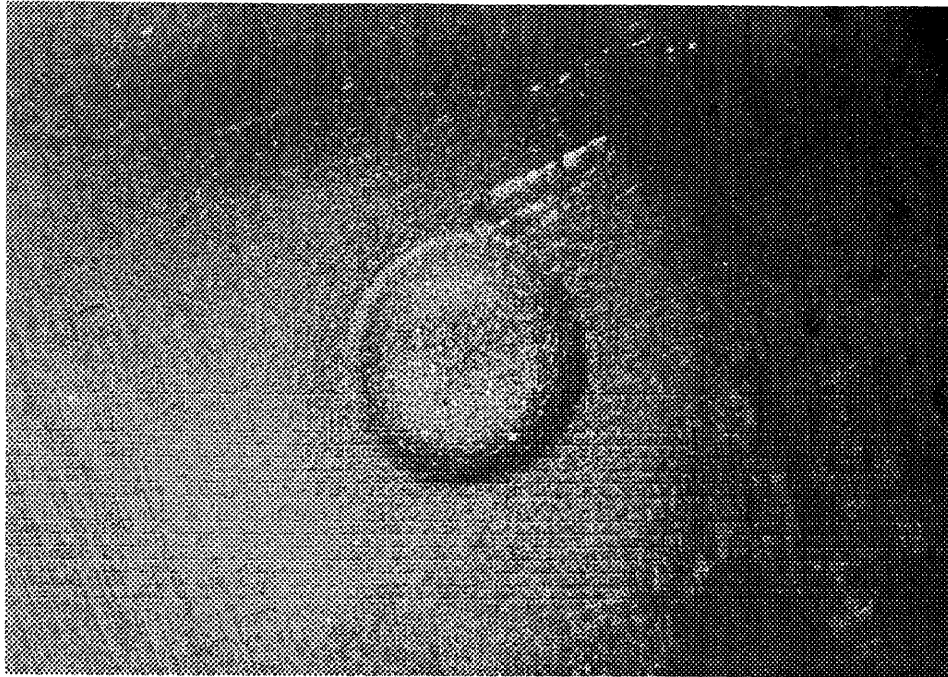

(a)

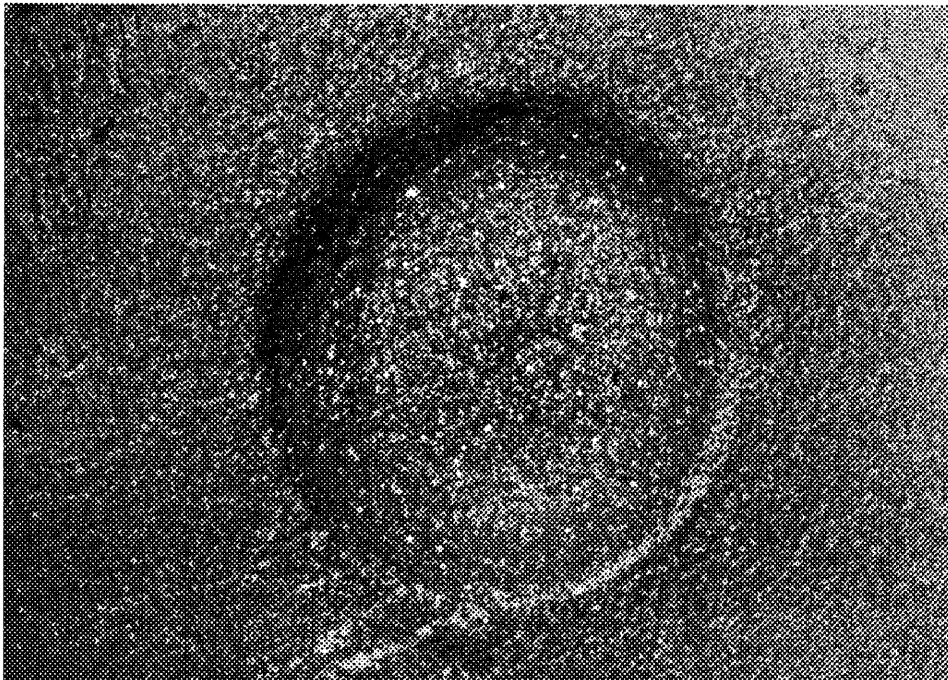

(b)

Figure C.4 Photographs of drilling of copper disk of thickness 1.7 mm, by WJ. (a) small magnification, (b) (X65). Notice not complete penetration of WJ through the disc body.

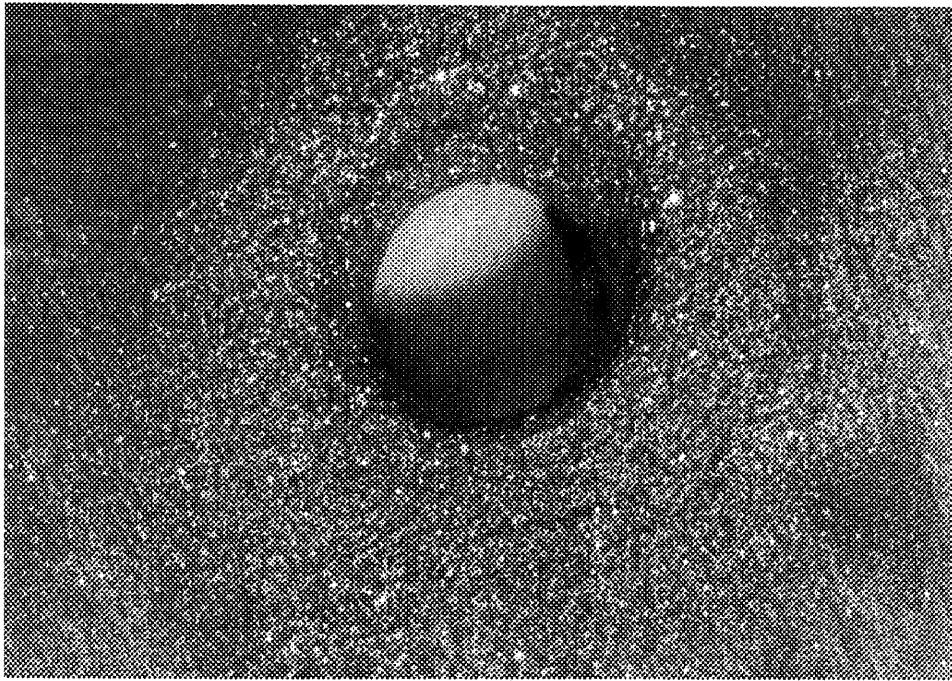

(a)

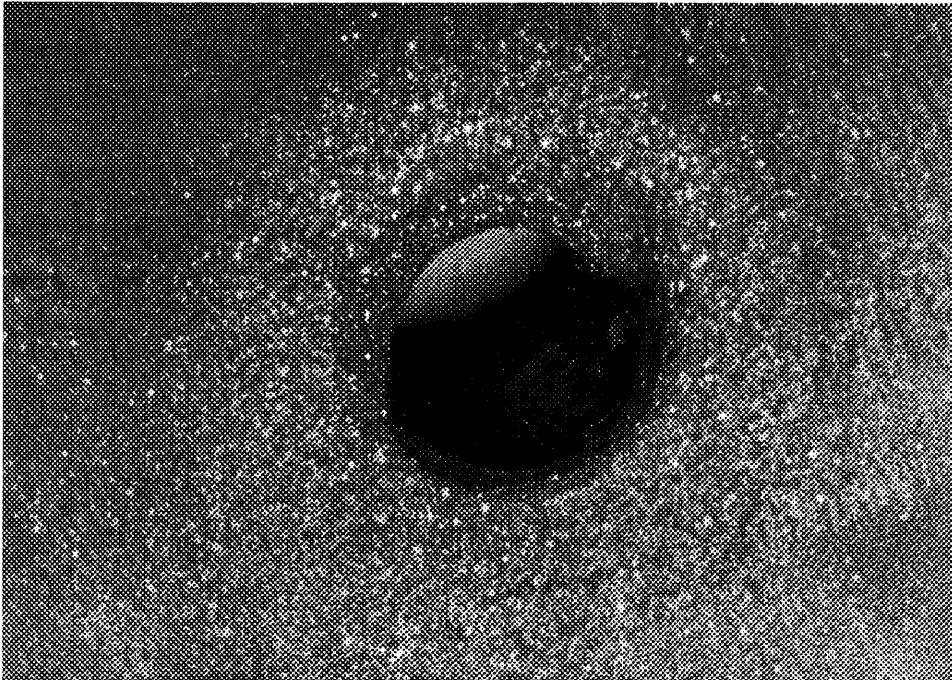

(b)

Figure C.5 Photographs of (a) and (b) drilling of copper disk of thickness of 1.7 mm, by IJ (X65). Notice complete penetration of IJ through the disc body.

APPENDIX D

PHOTOGRAPHS OF SAMPLES OF ICE AIRJET CLEANING

SET OF EXPERIMENT PARAMETERS

Air Pressure : 0.544 MPa

Stand Off Distance : 25.0 mm-50.0 mm

Diameter of Nozzle : 5.0 mm

Traverse Speed of Cleaning : 5.0 cm / min

Cleaning Mode : manual

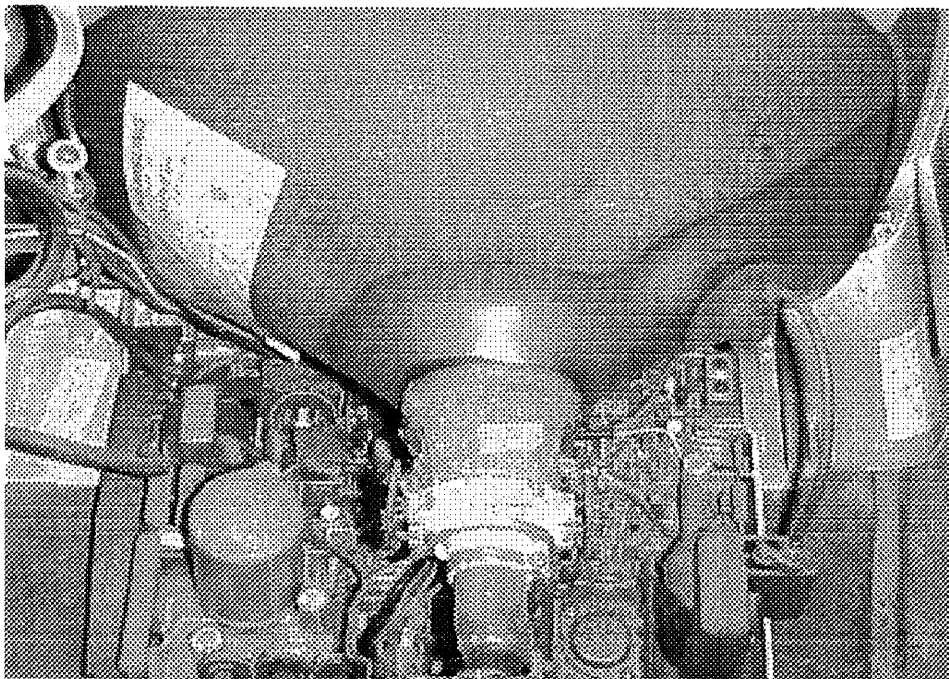

(a)

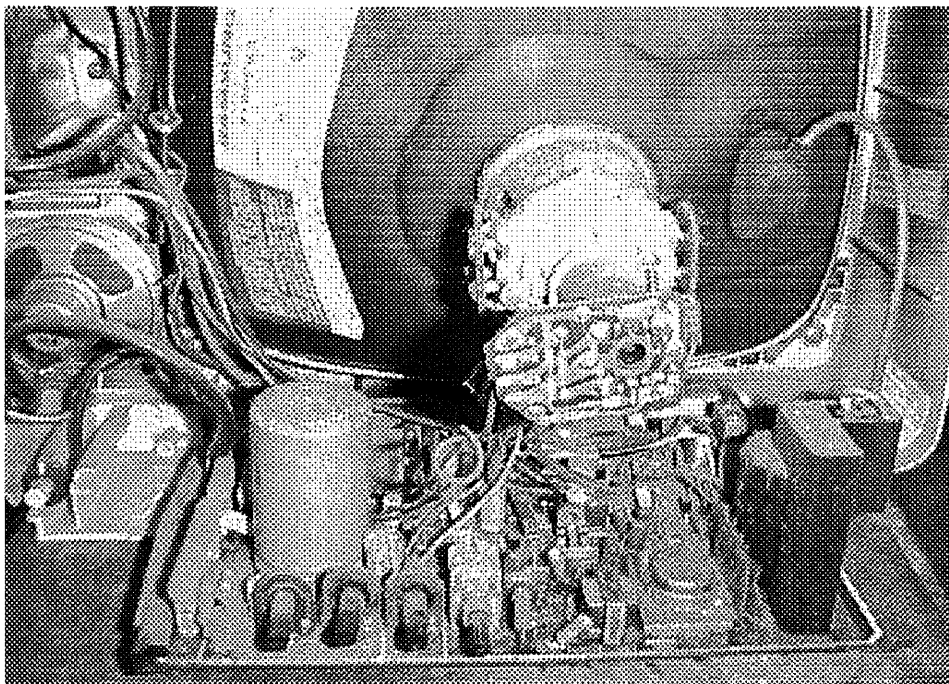

(b)

Figure D.1 (a) and (b) photographs of electronics board of TV set. Notice the heavy layers of dust and dirt on the electric and electronic components of board.

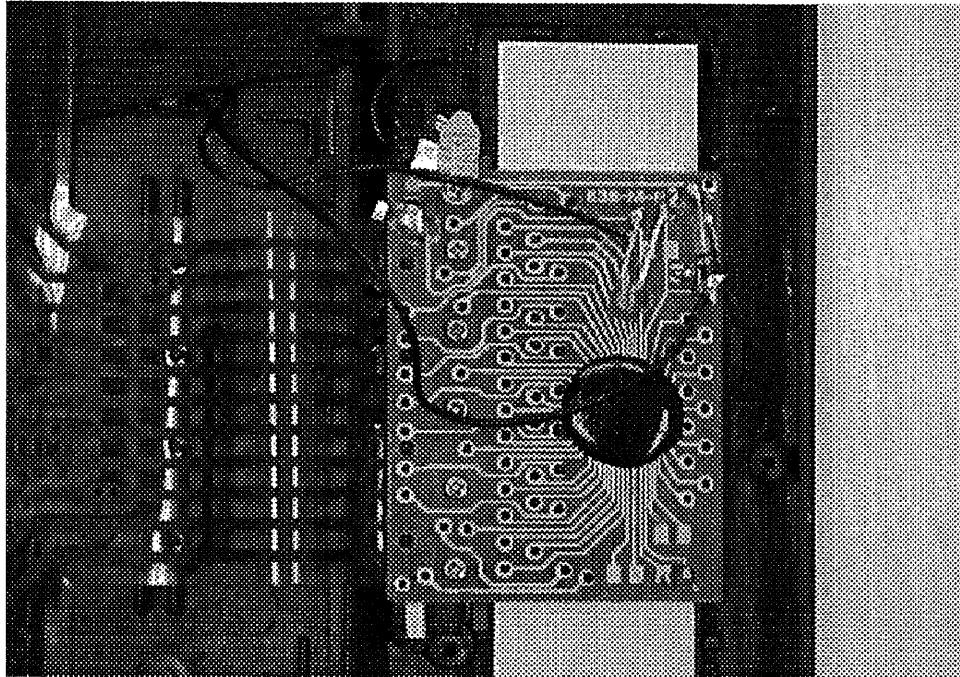

(a)

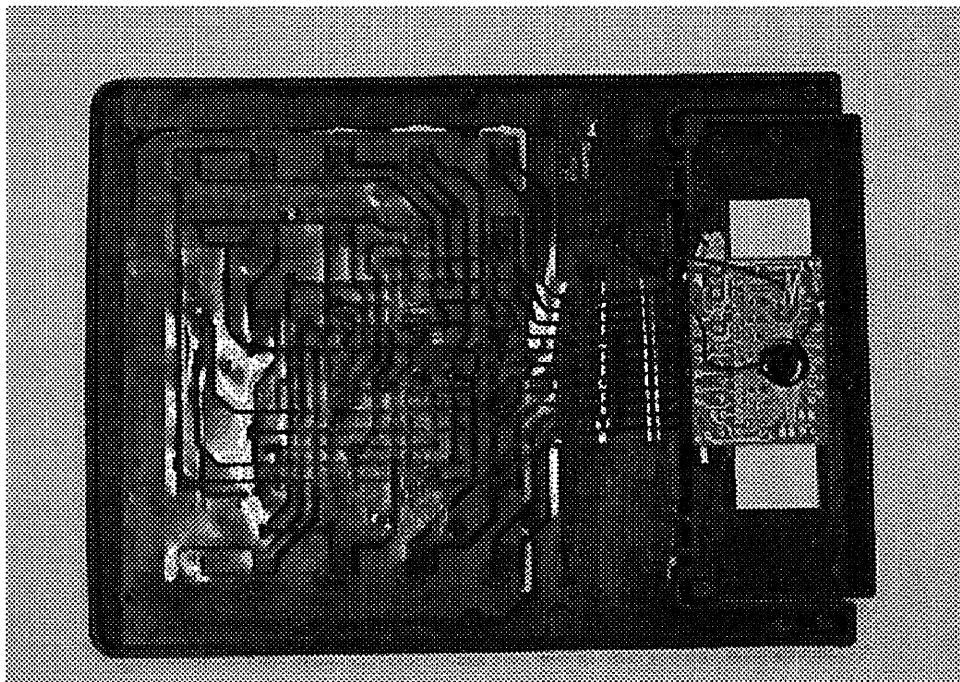

(b)

Figure D.2 (a) Photograph of the electronic board of the calculator. The calculator was disassembled and all components of the system including the LC display were covered by the mixture of lithium grease and copper powder, and (b) photograph of the calculator electronic board. Notice soft PVC electronic matrix of the calculator. The extremely sensitive surface of matrix was covered by the mixture of the lithium grease and copper powder. . After this coverage the calculator was disabled. After IJ cleaning the calculator performed normally.

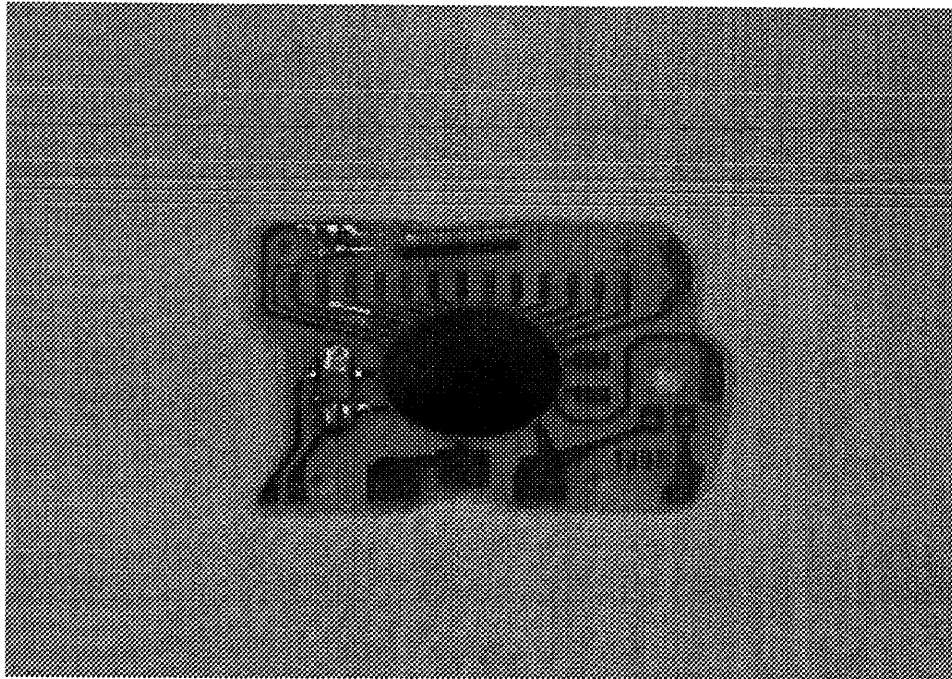

(a)

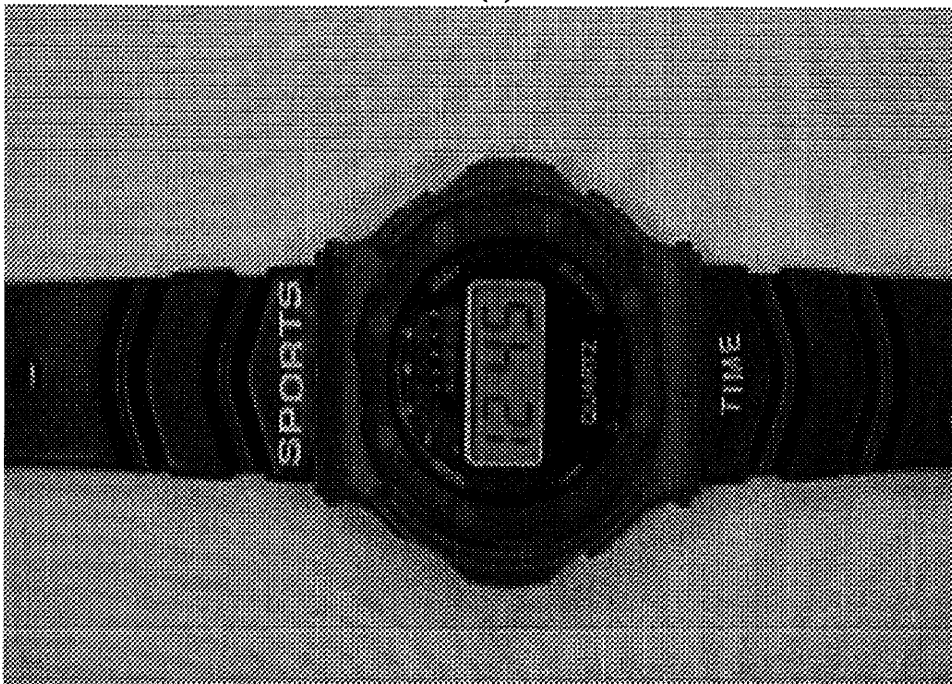

(b)

Figure D.3 (a) The electronic watches were disassembled and covered by the mixture of lithium grease and copper powder. After this the watches were disabled. Then all components of watches including microchips, conduits and LC displays were decontaminated, and (b) after IJ cleaning the watches performed normally.

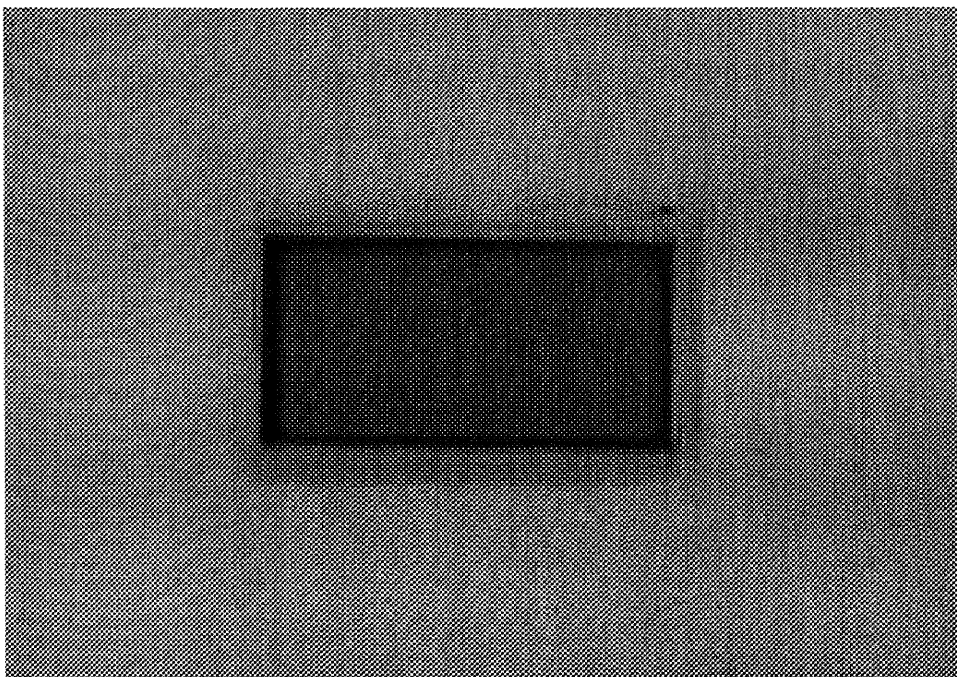

(a)

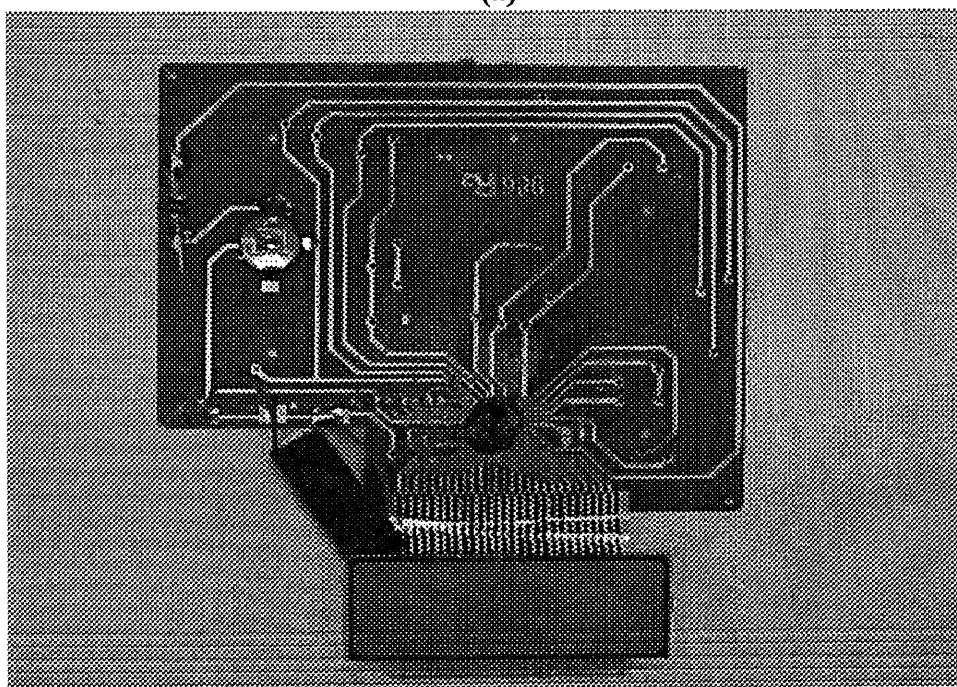

(b)

Figure D.4 (a) photograph of LC display of the electronic watch. Display was disabled by the lithium grease and then cleaned by IJ. After IJ cleaning extremely sensitive LC display performed normally, and (b) photograph of disassembled electronic board of the calculator containing microchip, LC display, solar panel element, conduits, diodes and battery. The board was contaminated by the mixture of lithium grease and copper powder and then decontaminated by IJ. After cleaning all elements of the board performed normally. No damage was induced to the vital electronic components of the system.

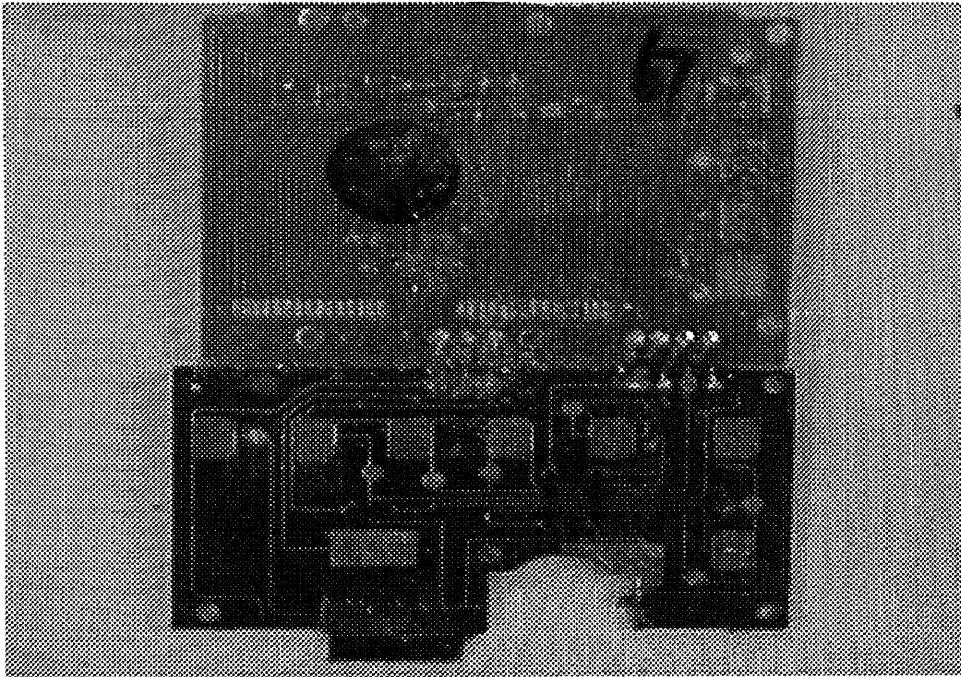

(a)

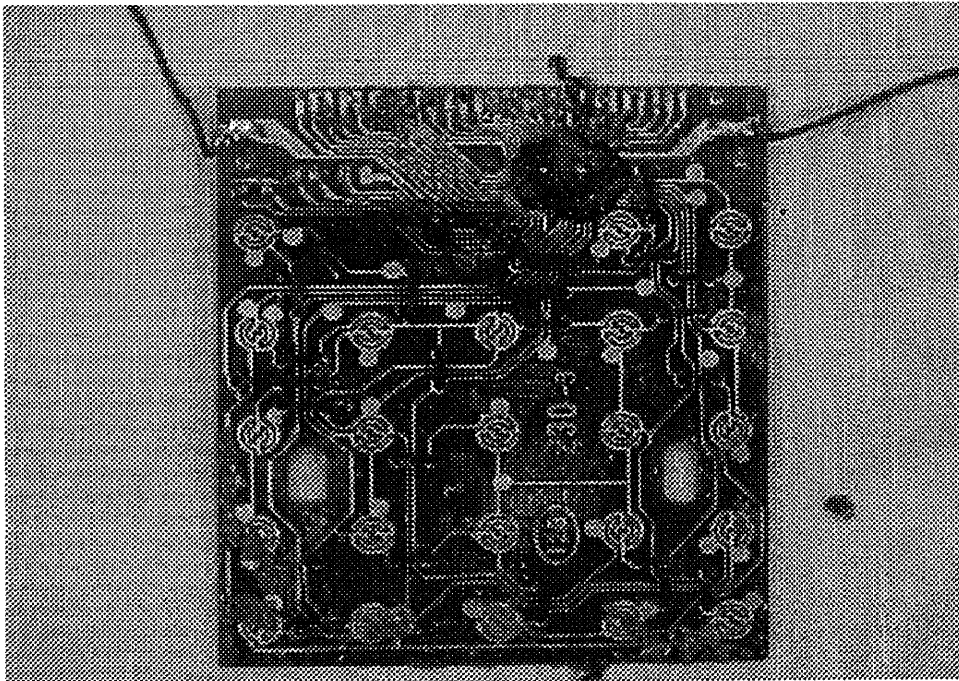

(b)

Figure D.5 (a) and (b) photographs of the board of the electronic games containing electric conduits, microchip and electronic matrix. The board was covered by the mixture of the lithium grease and copper powder and disabled. Notice the cross contamination of electric conduits of the board. After cleaning the game performed normally.

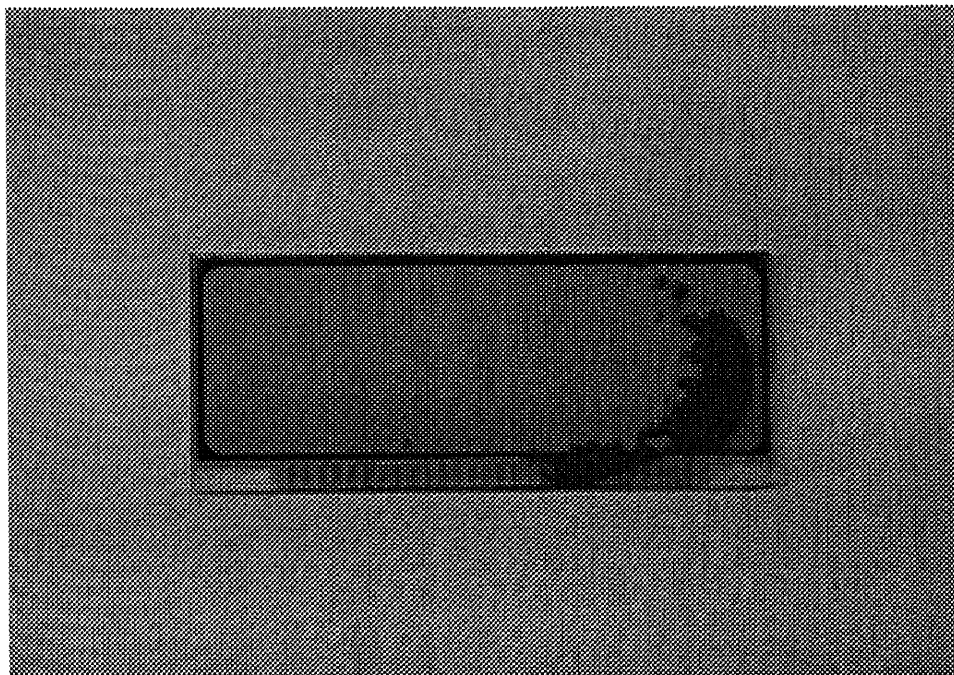

(a)

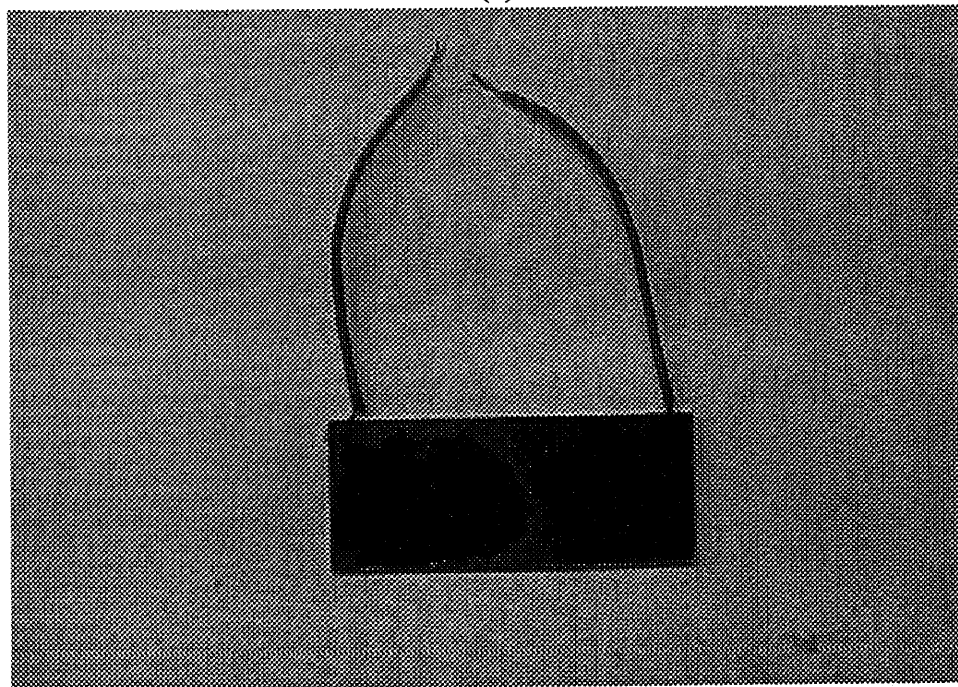

(b)

Figure D.6 (a) photograph of the LC display of the calculator containing electronic matrix and LCD conduits. The display was contaminated by Rust-Oleum gloss protective enamel. Then all elements of LC display were decontaminated by IJ. In assembly of the calculator the LC display performed normally, and (b) photograph of the solar panel element of the calculator containing electronic matrix and conduits. The solar panel was contaminated by heavy layer of Rust-Oleum gloss protective enamel and then decontaminated by IJ. In the assembly of the calculator the solar panel performed normally. Notice that the semiconductor elements of the matrix are highly sensitive.

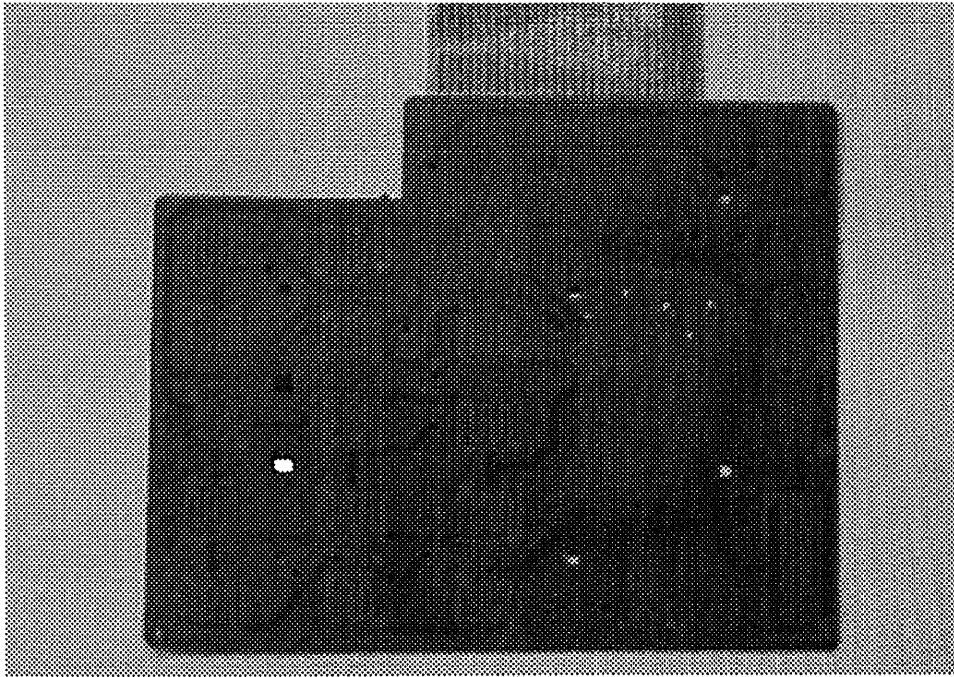

(a)

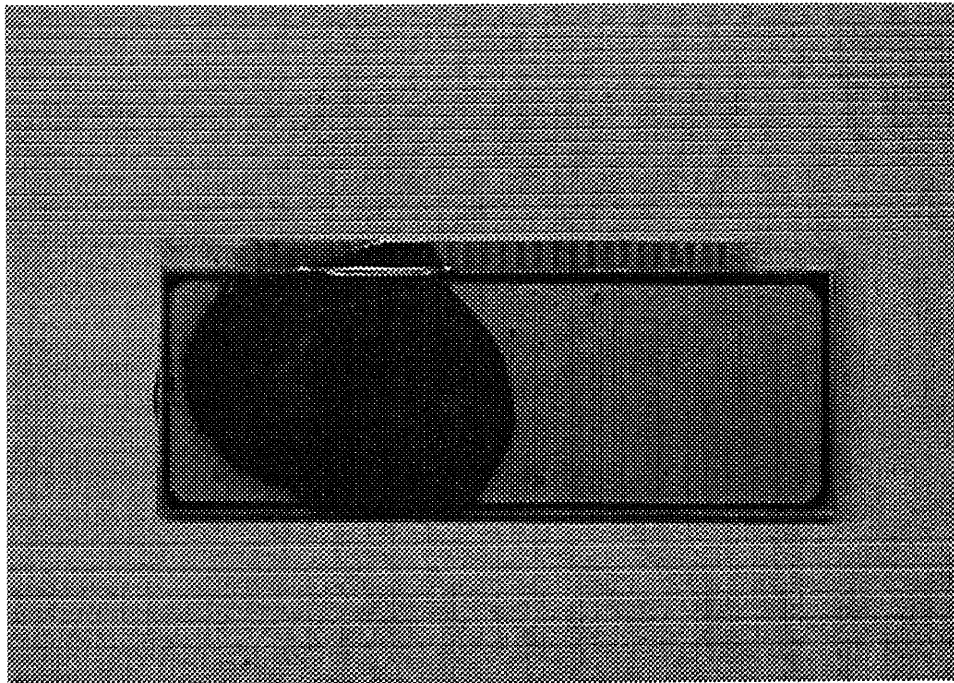

(b)

Figure D.7 (a) photograph of the electronic board of the calculator containing electronic matrix. The electronic board was contaminated by Rust-Oleum gloss protective enamel. Then electronic board was decontaminated by IJ. In assembly of the calculator the electronic board worked normally, and (b) photograph of the LC display covered by the heavy layer of Rust-Oleum gloss protective enamel. Notice the cross-contamination of the electrical conduits of LCD.

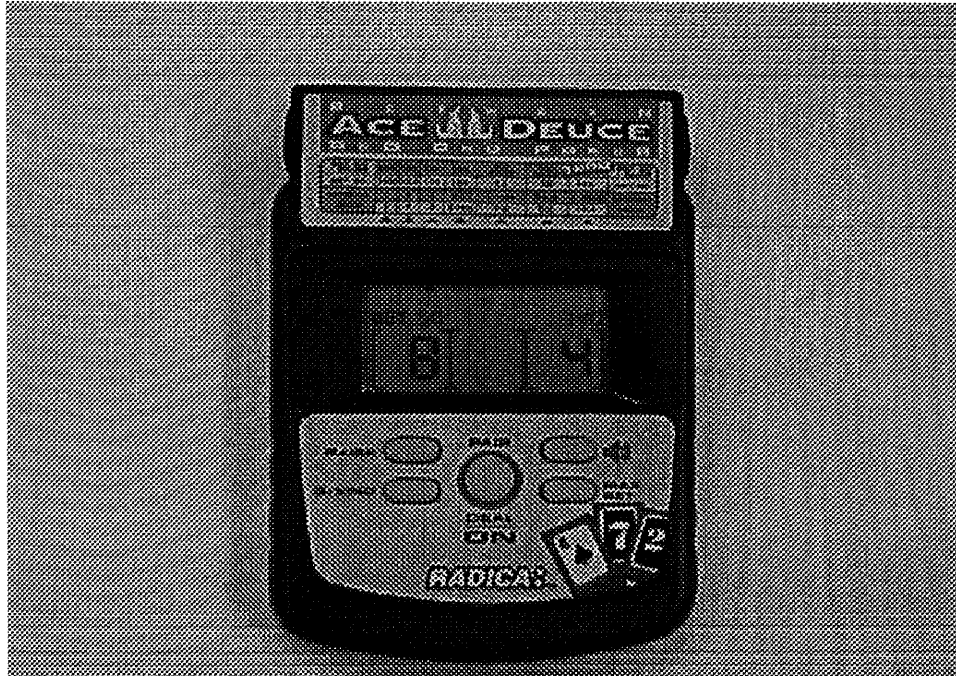

(a)



(b)

Figure D.8 (a) and (b) photographs of the electronic games in assembly after IJ cleaning. The electronic games performed normally

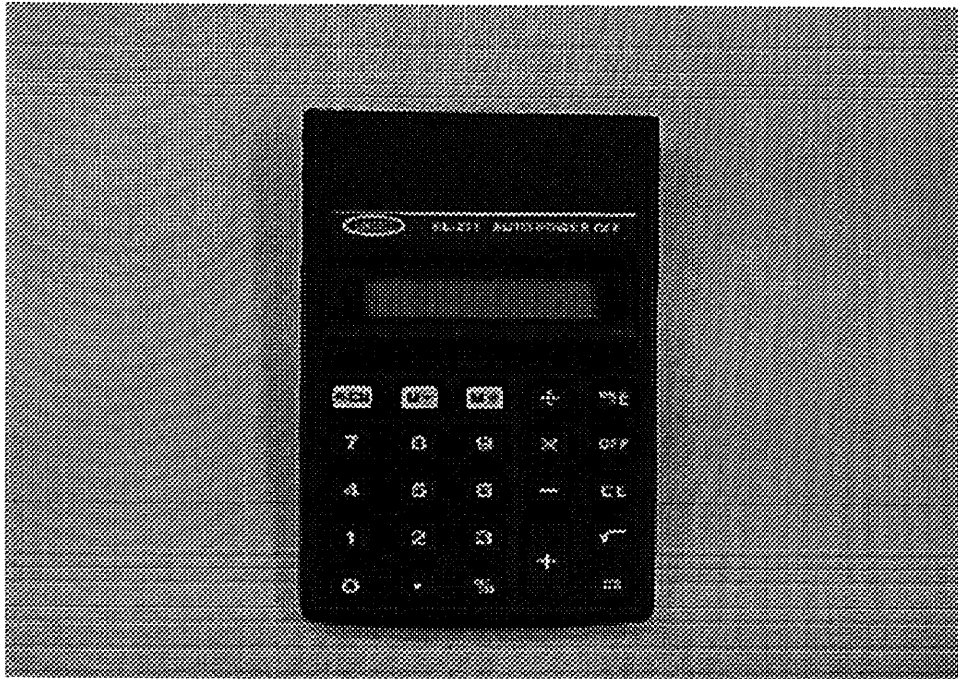

(a)

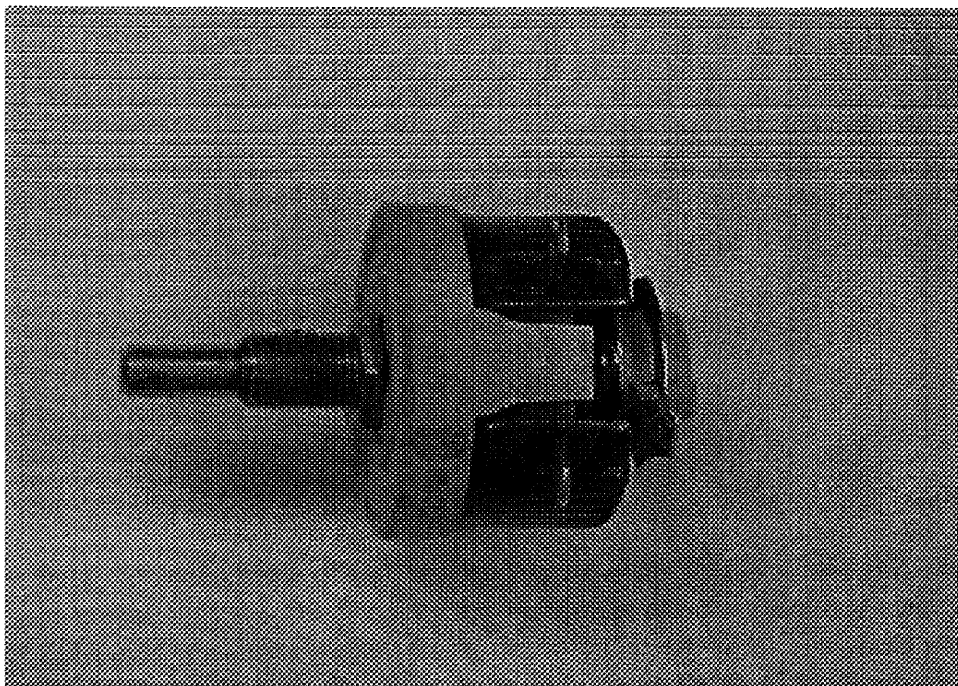

(b)

Figure D.9 (a) photograph of the calculator cleaned by IJ in assembly. The assembled electronic calculator operated normally, and (b) photograph of the electrical varistor. The varistor was contaminated by the mixture of the lithium grease and copper powder. Then the varistor was cleaned by IJ. After cleaning varistor worked normally. Notice the complicated geometry of the varistor surface. The feasibility of cleaning of complicated surfaces was demonstrated.

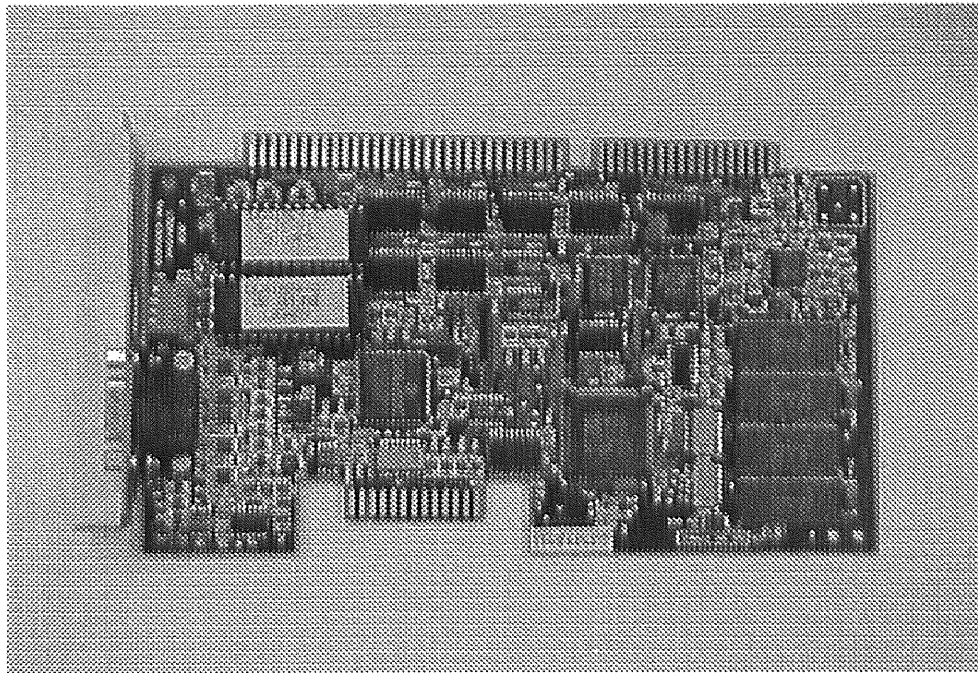

(a)

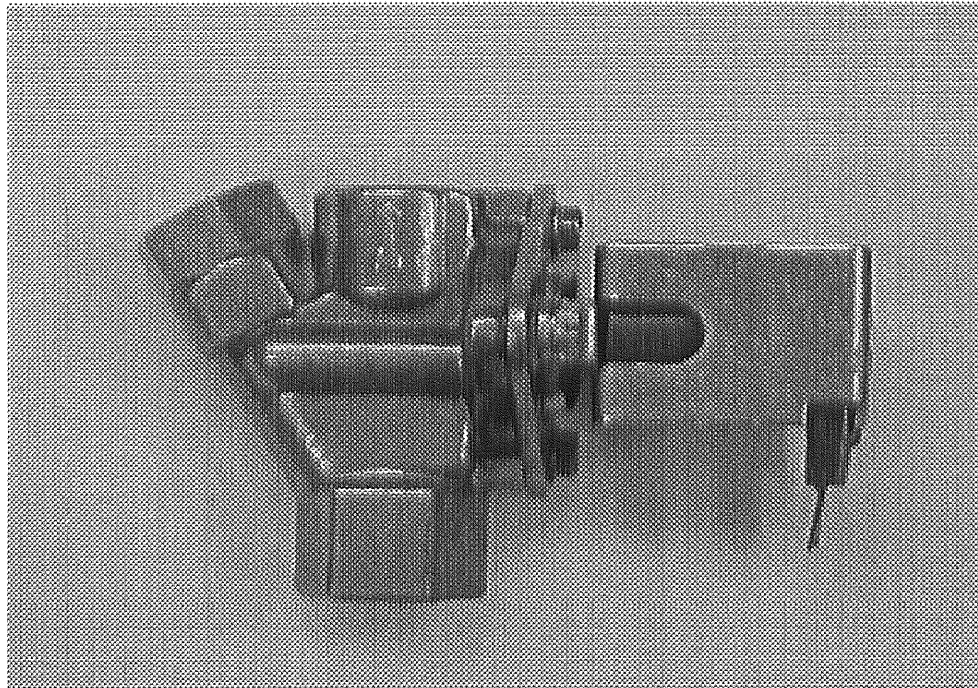

(b)

Figure D.10 (a) photograph of the monitor board of PC Brook 486DX33. The monitor board was contaminated by the heavy layer of the mixture of lithium grease and copper powder and disabled. Then the board was decontaminated by IJ. The board performance was normal in assembly with PC. The feasibility of restoration of complicated electronic parts was demonstrated, and (b) photograph of the electrical solenoid valve with connectors contaminated by Rust-Oleum gloss protective enamel. The contacts of solenoid valve were cleaned by IJ. After cleaning the solenoid valve was connected to the electrical supply source and performed normally. This experiment demonstrated the feasibility of using IJ technique for decontamination and restoration of contacts of different electronic devices.

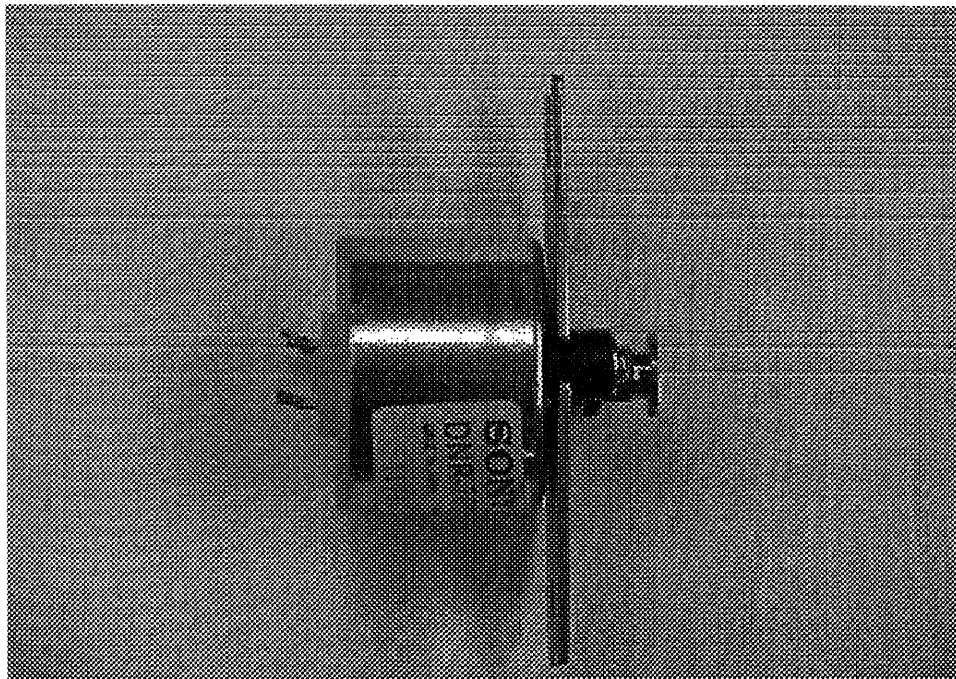

(a)



(b)

Figure D.11 (a) photograph of the DC motor. DC motor was disassembled and all elements were covered by the mixture of lithium grease and copper powder. DC motor was cleaned by IJ. In assembly DC motor performed normally, and (b) photograph of TV set in assembly. The contaminated board of TV set is shown in Figure D.1. After cleaning TV set worked normally.

CLEANING OF DELICATE SURFACES

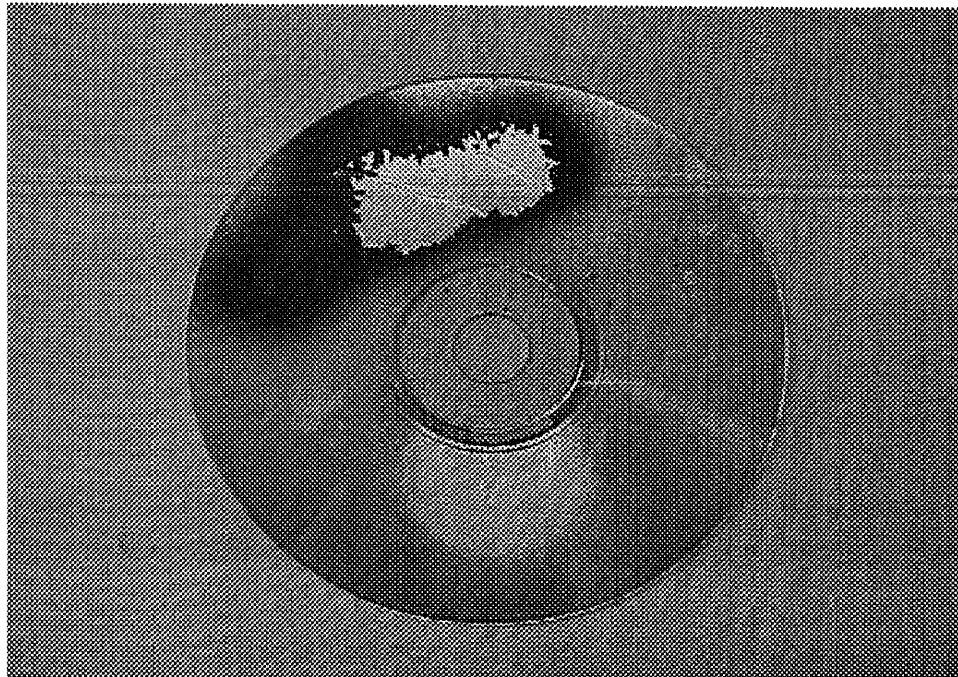

(a)

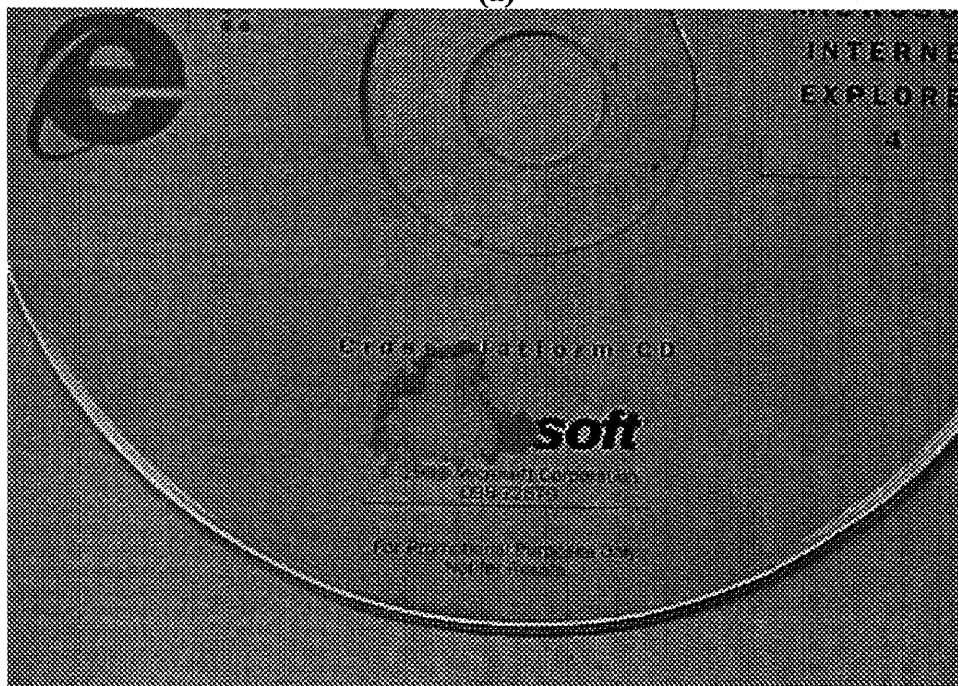

(b)

Figure D.12 (a) photograph of the CD-ROM covered by Rust-Oleum gloss protective enamel. The paint was partially removed from the CD ROM surface. No surface damage was observed in the course of IJ cleaning, and (b) photograph of the CD-ROM partially cleaned by using of IJ technique. Notice that both layers of paint and emulsion were removed. No surface damage was observed in the course of IJ processing.

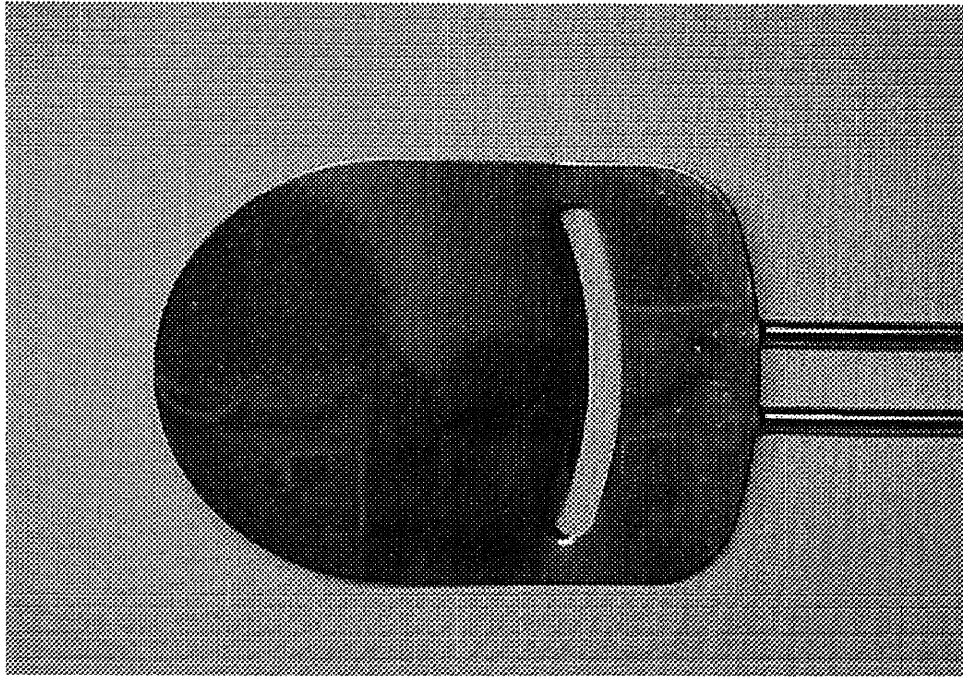

(a)

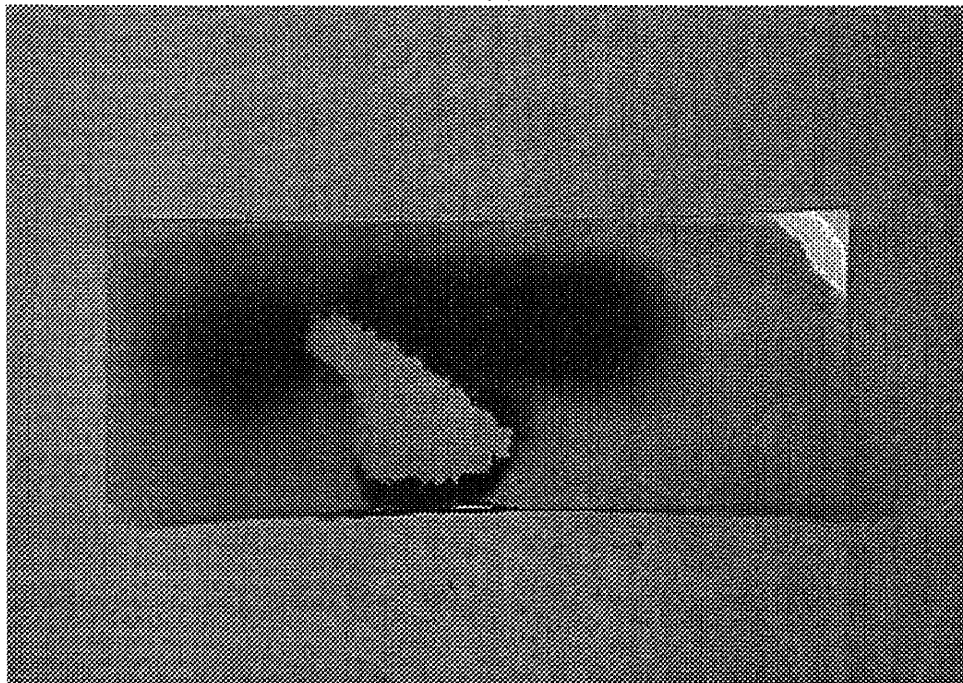

(b)

Figure D.13 (a) Photograph of the polished steel surface. The polished steel surface was contaminated by the Rust-Oleum gloss protective enamel. The paint was partially removed from the polished surface. No surface damage was observed in the course of IJ cleaning. The feasibility of the precision cleaning of polished surfaces was demonstrated, and (b) photograph of the strip of soft plastic covered by Rust-Oleum gloss protective enamel. The paint was partially removed from the plastic surface. No surface damage was observed. The feasibility of restoration and fabrication of plastic parts was demonstrated.

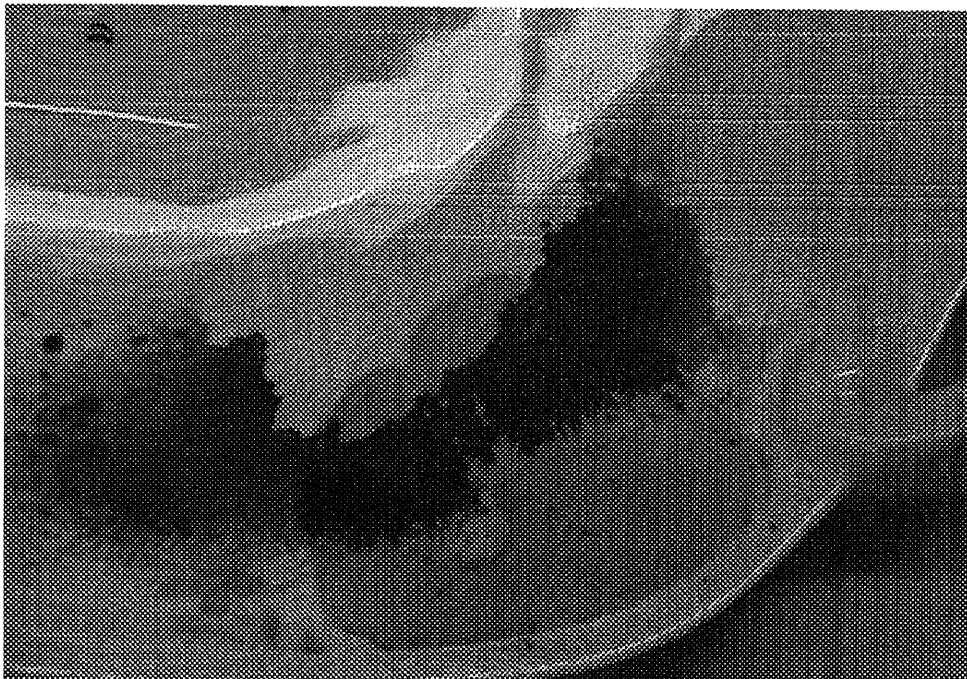

(a)

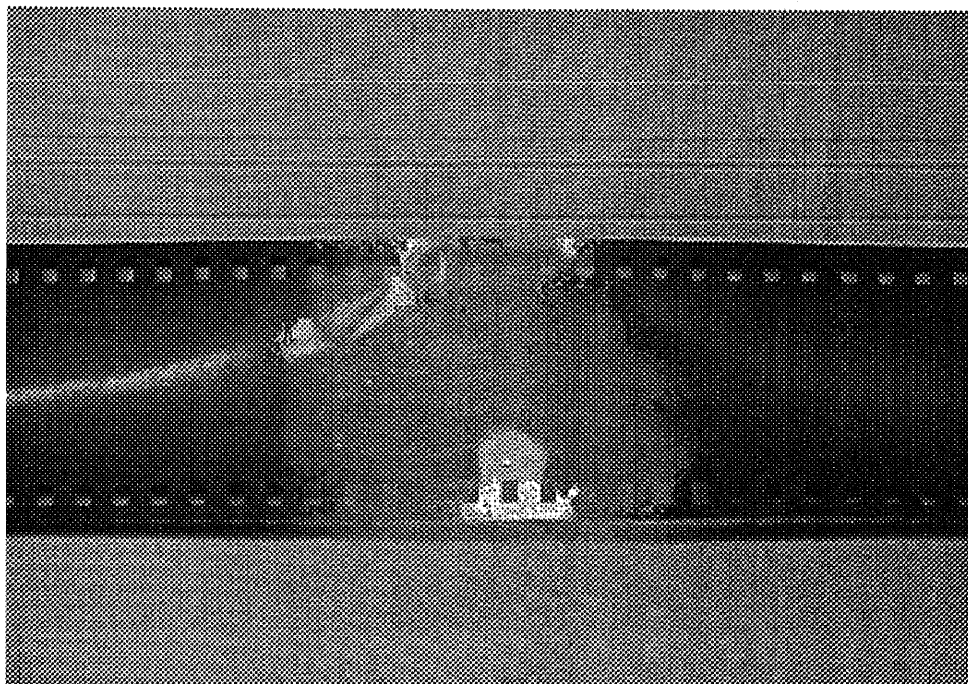

(b)

Figure D.14 (a) Photograph of the hand-painted china plate. The plate was covered by Rust-Oleum gloss protective enamel. Part of the deposited paint was removed by ice etching. No modification of the original surface was noticed. The feasibility of IJ etching of sensitive surfaces was demonstrated, and (b) photograph of the strip of the photo film. The photo emulsion was partially removed from the film surface. No surface damage was observed in the course of IJ. The feasibility of complete and selective emulsion removal from thin film was demonstrated.

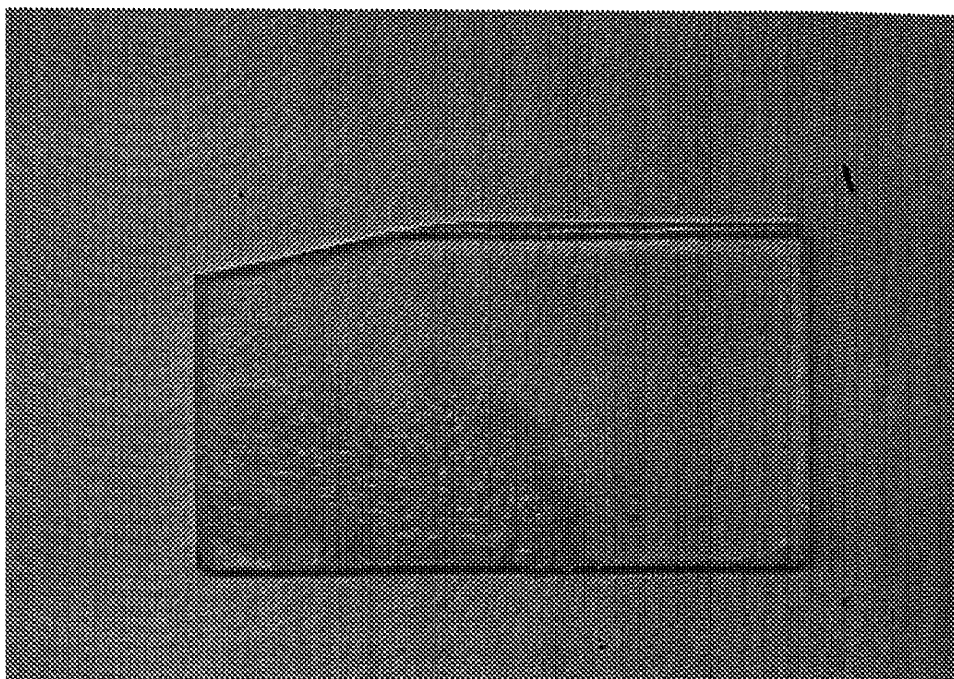

(a)



(b)

Figure D.15 (a) photograph of the strip of an organic glass covered by the lithium grease. The part of the contaminant was successfully removed by IJ. No damage of the original surface was observed. The feasibility of complete removal of the organic substances from different substrates was demonstrated, and (b) photograph of the of a cotton fabric. The fabric was contaminated by the Rust-Oleum gloss protective enamel. Then the paint was partially removed from fabric surface. The feasibility of the use of ice particles for decontamination of different fabrics was demonstrated.

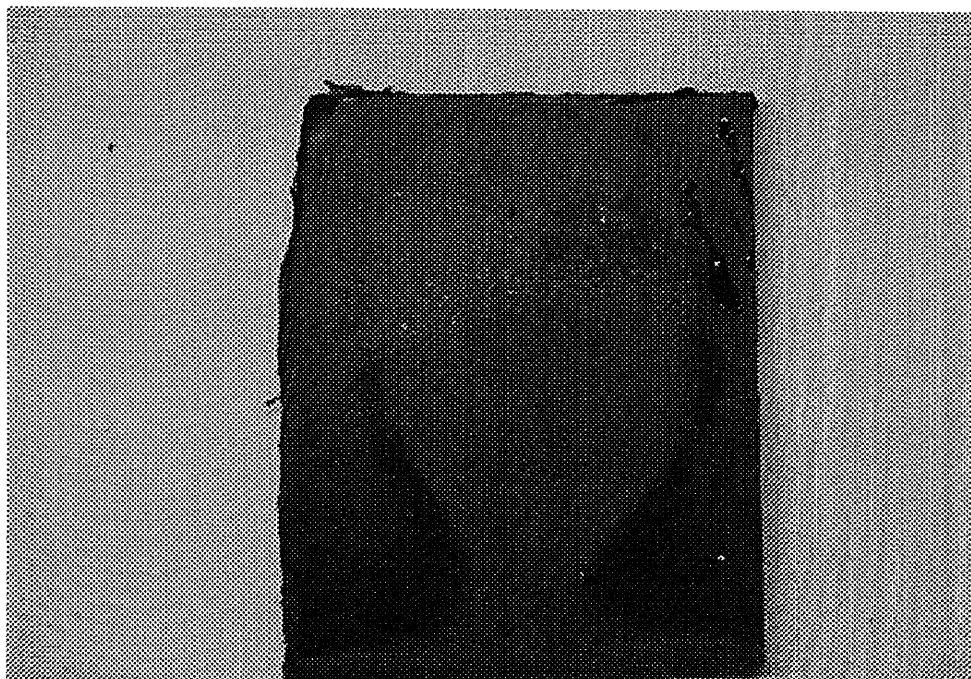

(a)



(b)

Figure D.16 (a) Photograph of the hard plastic covered by the Rust-Oleum gloss protective enamel. The paint was partially removed by IJ. The feasibility of restoration and fabrication of plastic parts was demonstrated, and (b) photograph of the cover of a pharmaceutical reactor contaminated by the lithium grease. Then the grease was partially removed from the surface of the cover by IJ. No damage of the Phaulder glass in the course of IJ cleaning was noticed.



(a)

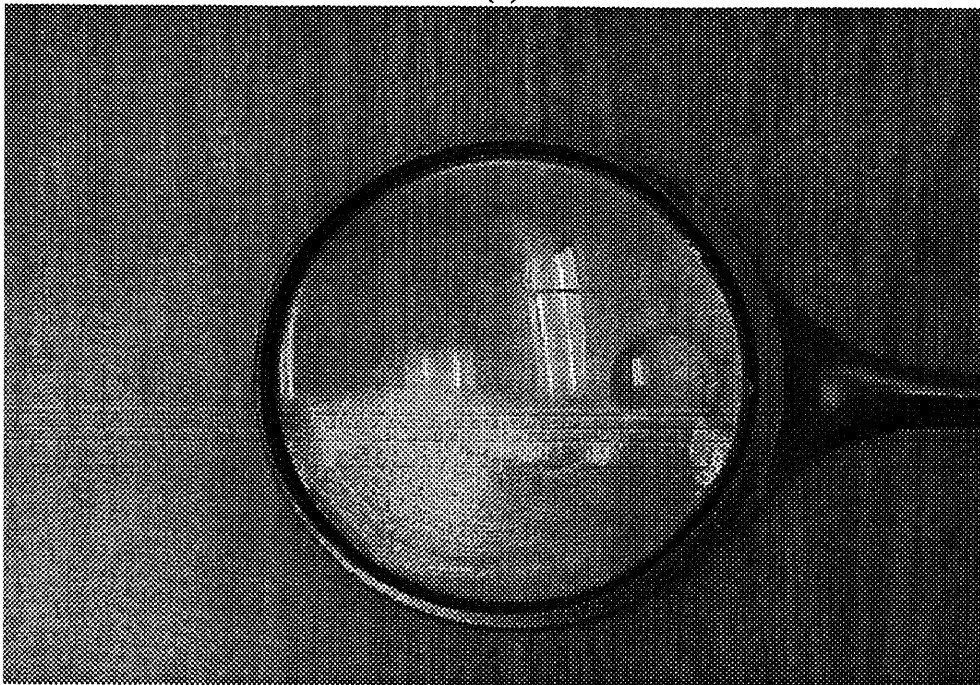

(b)

Figure D.16 (a) photograph of the photo camera. The lenses of the camera were contaminated by the lithium grease. Then the lenses were cleaned by IJ. After cleaning the camera performed normally. No damage of the surface of lenses was noticed. The feasibility of decontamination of different optical devices was demonstrated, and (b) photograph of the magnification lens. The lens was contaminated by the lithium grease. The grease was partially removed from the lens surface. Notice that no damage of the lens surface was observed.

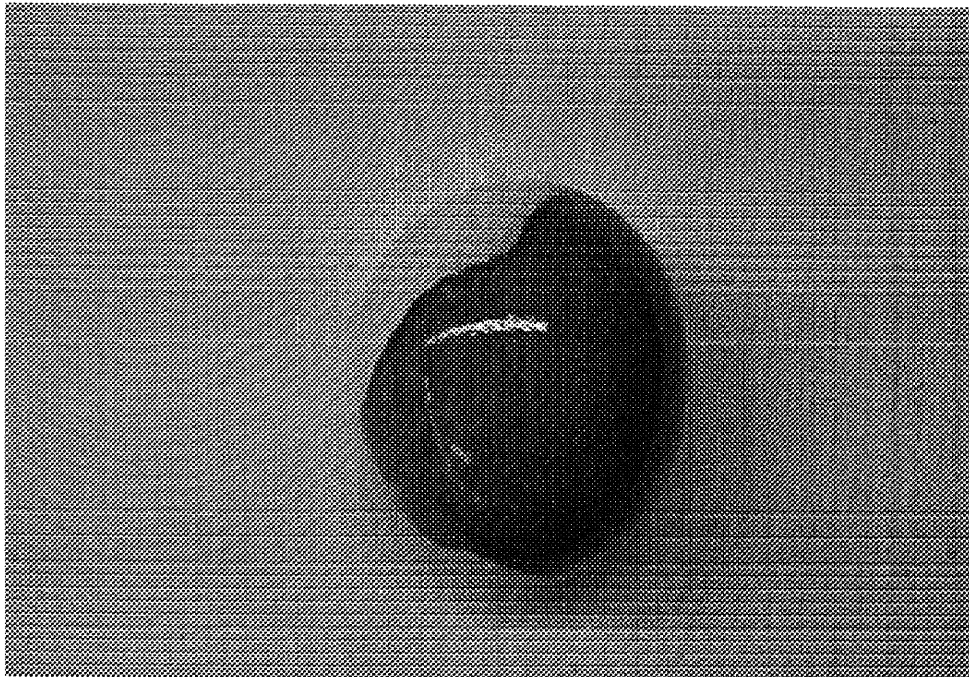

(a)

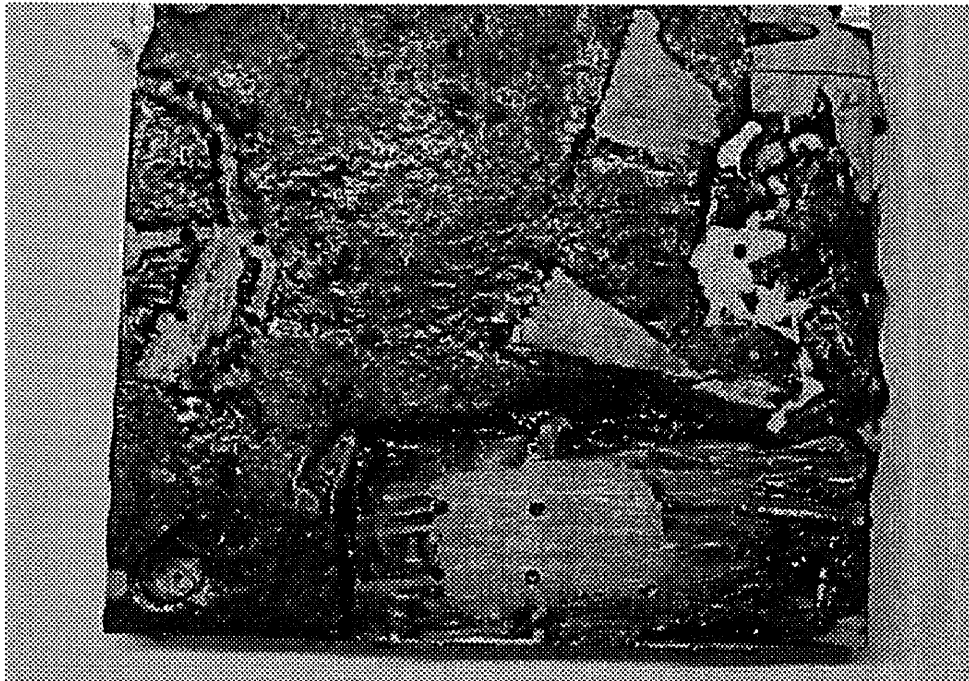

(b)

Figure D.17 (a) photograph of the egg. The egg surface was painted by Rust-Oleum gloss protective enamel. After this the egg was partially decontaminated by IJ. No damage of the egg surface or penetration of the ice particles through the egg shell was noticed. The feasibility of decontamination of highly unstable and brittle surfaces was demonstrated, and (b) photograph of the grinded aluminum surface contaminated by the thick layer of tar. The bulk of the tar was removed by WJ and knife scrubbing. The highly adhesive thin layer was removed by ice etching. No damage of the metal surface was noticed.

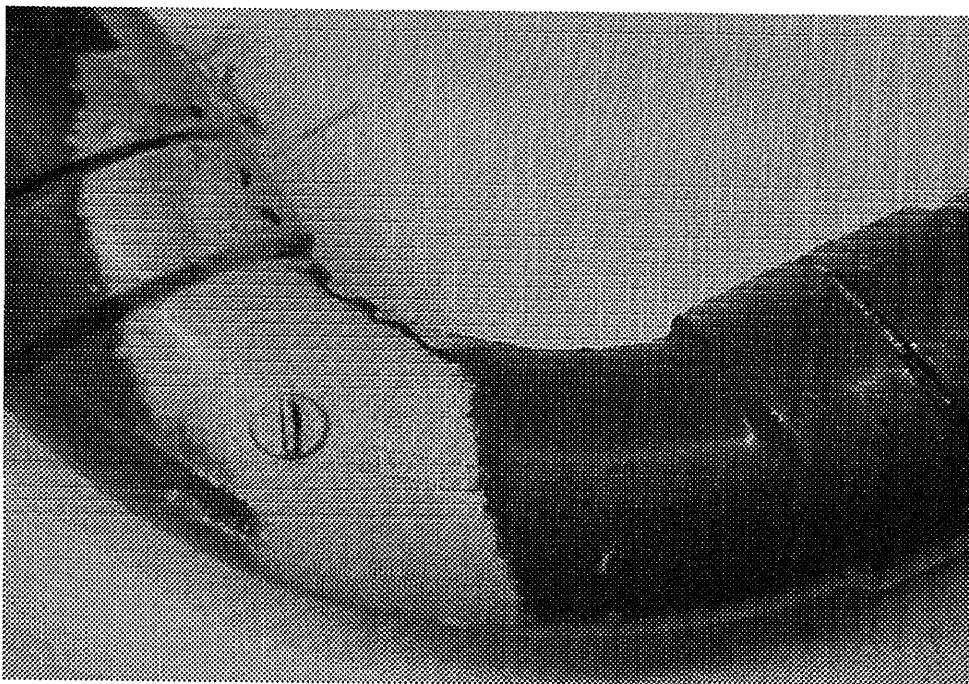

(a)

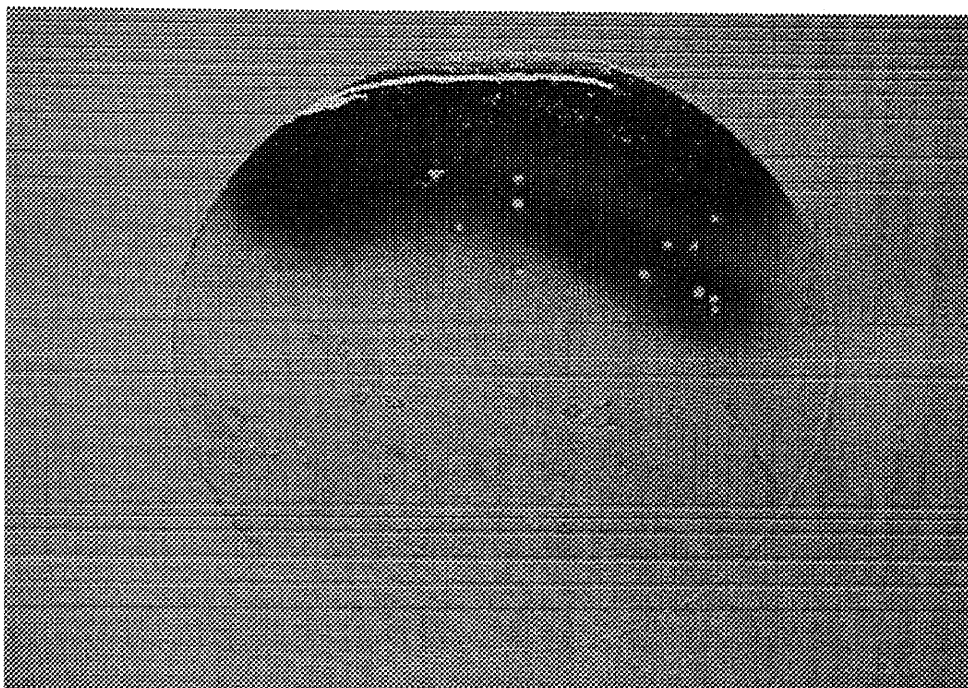

(b)

Figure D.18 (a) photograph of a PVC tube contaminated by Rust-Oleum gloss protective enamel. The tube was partially decontaminated by IJ. No damage of the tube surface in the course of IJ cleaning was noticed, and (b) photograph of the thin glass disc painted by Rust-Oleum gloss protective enamel. The paint was partially removed from the glass surface. The glass surface remains without damage. Notice that the thickness of the glass not exceed 1 mm.

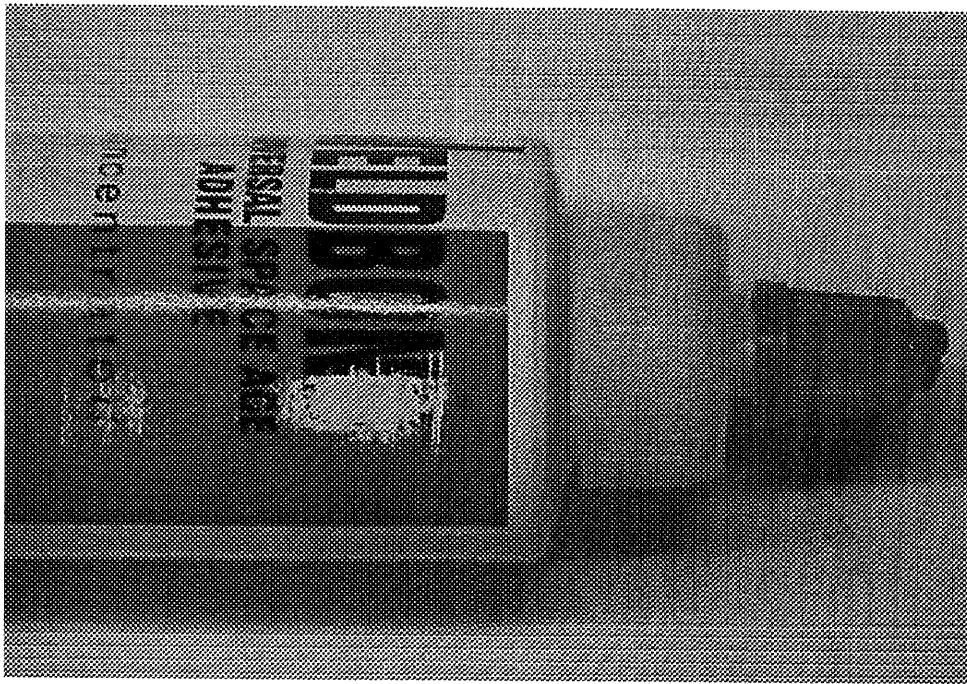

(a)

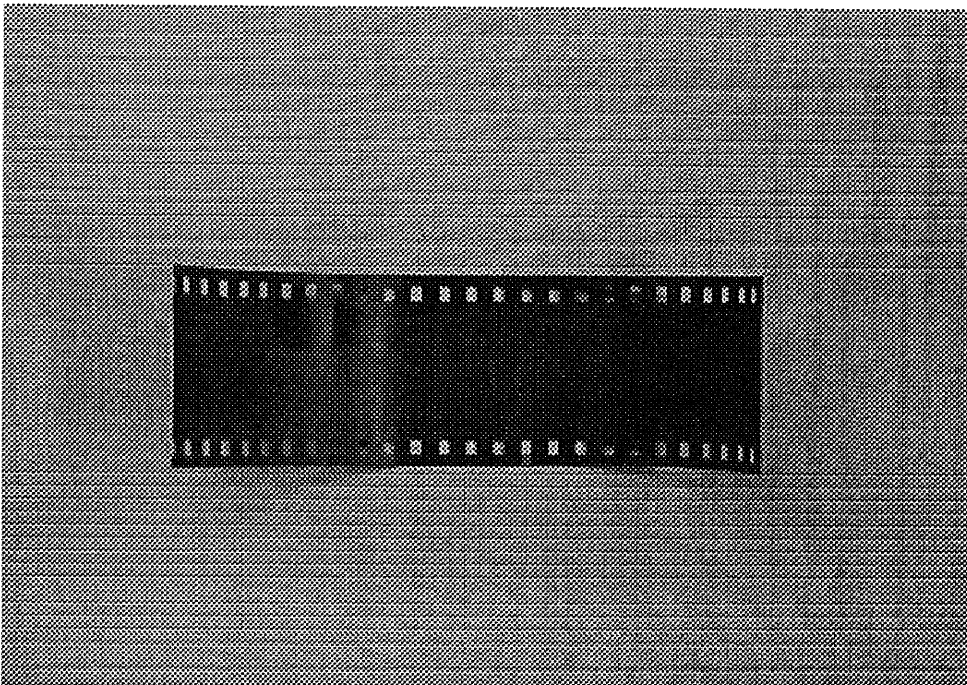

(b)

Figure D.18 (a) photograph of a plastic part. The part of coating was removed from the surface of the plastics. No damage of the substrate layer of the plastics was noticed. No penetration of the ice particles into the plastic body was noticed as well, and (b) photograph of the strip of photo film painted by Rust-Oleum gloss protective enamel. The part of the paint was removed by using of IJ technique. Notice that the underlying layer of emulsion remains without damage. The feasibility of restoration and fabrication of highly sensitive plastic parts was demonstrated.

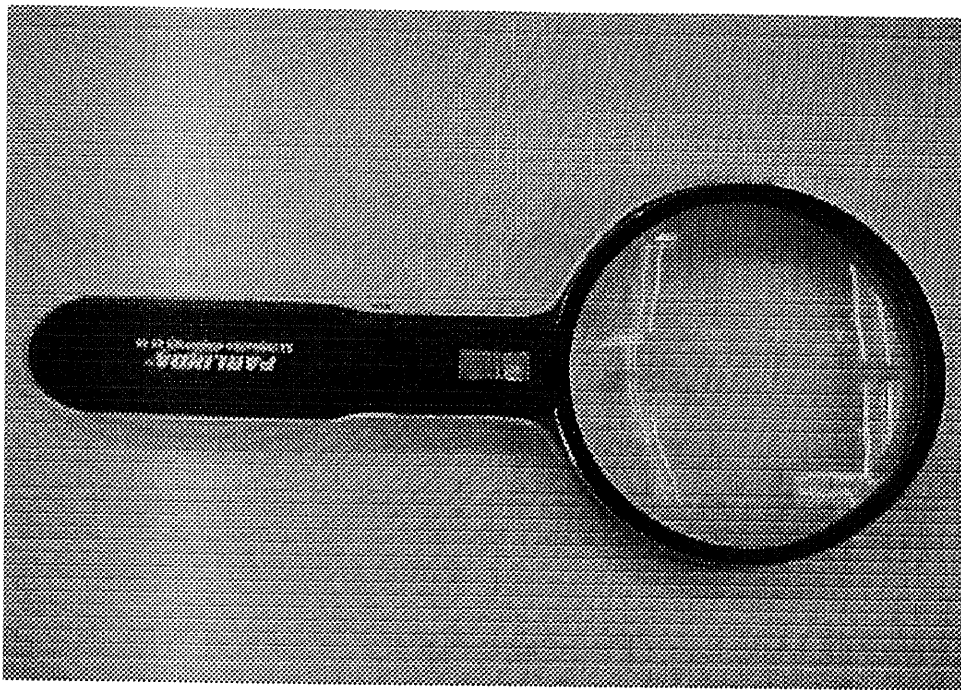

(a)

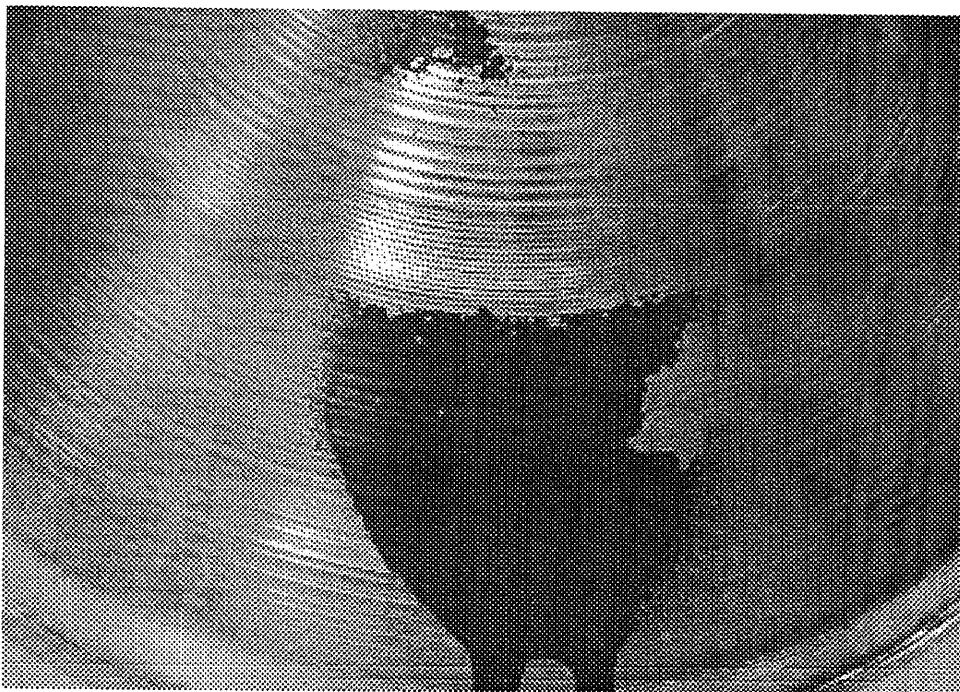

(b)

Figure D.19 (a) photograph of a magnification lens previously contaminated by the lithium grease. The grease was completely removed from the lens surface by using IJ technique. No surface damage in the course of IJ cleaning was noticed, and (b) photograph of grinded aluminum surface partially cleaned by ice particles. The aluminum surface was covered by the layer of Rust- Oleum gloss protective enamel. No surface damage was noticed.

BIBLIOGRAPHY

1. B. Herb and S. Visaisouk, *Ice Blast Technology for Precision Cleaning, in Precision Cleaning*, Witter Publishing Company, Anaheim, California, 1996.
2. E.S. Geskin, D. Shishkin, K. Babets, *Ice, Cryogenic and Polymer Added Jets* ", Chapter in the Book, "Abrasive Water Jet, a View on Future", to be published by Institute for Industrial Technologies and Automation, June 1999.
3. C. M. Dunskey and M. Hashish, "Observation of Cutting with Abrasive Cryogenic Jets, Jetting Technology-Application and Opportunities", *Proceedings of 13th International Conference on Jetting Technology*, BHR Group, Spain, Sardinia, Publication 21, 1996, pp. 679-690.
4. M. Hashish and C. M. Dunskey, " The Formation of Cryogenic and Abrasive Cryogenic Jets, in Jetting Technology", *Proceedings of 14th International Conference on Jetting Technology*, BHR Group, Brugge, Belgium, 1998, pp. 329-343.
5. R. Sherman and P. Adams, *Carbon Dioxide Snow Cleaning- the Next Generation of Clean, in Precision Cleaning*, Witter Publishing Company, Anaheim, California, 1996, pp. 280-303.
6. D. Sammers, *Waterjetting Technology*, E & FN Spon, New York, 1995, pp. 673-687.
7. R. Lombardi, "Ultra-High Pressure Non-Abrasive Polymer Jetting, A Production Environment Implementation", *Proceedings of 9th American Waterjet Conference*, Dearborn, Michigan, August 1997, pp. 251-256.
8. P. Hobbs, *Ice Physics*, Clarendon Press, Oxford, England, 1974.
9. N. Fletcher, *The Chemical Physics of Ice*, Cambridge at the University Press, Cambridge, Massachusetts, 1970.
10. K. Raissi, A. Corier, D. Kremer, "Mixing Tube Geometry Influence on Abrasive Waterjet Flow", Jetting Technology-Applications and Opportunity, *Proceeding of 13th American Waterjet Conference*, BHR Group, Sardinia, Spain, 1996, publication 21, pp. 247-269.
11. D. Osman, B. Buisine, B. They, "Measure of Air Flow Rate According to the Mixing Chamber Design", In Jetting Technology-Applications and Opportunity, *Proceeding of 13th American Waterjet Conference*, BHR Group, Sardinia, Spain, publication 21, pp. 223-237.

12. E. S. Geskin, L. Tismenetskiy, E. Bakhromi, F. Li, "Investigation of Ice Jet Machining", *Proceedings of International Symposium on Electric Machining*, Lausanne, Switzerland, 1995, pp. 833-890.
13. E. Geskin, Tismenetskiy, E. Bakhromi, F. Li, "Investigation of Icejet Machining", *Proceedings of 1995 NSF Design and Manufacturing Grantees Conference*, San Diego, California, 1995.
14. E. Geskin, Tismenetskiy, E. F. Li, "Investigation of Icejet Machining", *Proceedings of 1996 NSF Design and Manufacturing Grantees Conference*, Albuquerque, France, 1996.
15. E. Geskin, Tismenetskiy, E. F. Li, D. Shishkin, "Investigation of Icejet Machining", *Proceedings of 1997 NSF Design and Manufacturing Grantees Conference*, Seattle, USA, 1997.
16. E.S. Geskin, L. Tismenetskiy, F. Li, P. Meng and D. Shishkin, "Investigation of Icejet Machining", *Proceedings of 9th American Waterjet Conference*, Houston, Texas, August 1997, pp. 281-290.
17. E. Geskin, D. Shishkin, K. Babets, "Investigation of Ice Jet Machining", *Proceedings of 1999 NSF Design and Manufacturing Grantees Conference*, Long Beach, California, January 1999.
18. F. Li, E. S Geskin, and L. Tismenetskiy, "Development of Icejet Machining Technology", *Proceedings of 8th American Water Jet Conference*, Houston, Texas, 1995, pp.671-680.
19. F. Li, E.S. Geskin, L. Tismenetskiy, "Development of Icejet Machining Technology", *Proceeding of XIII International Symposium on Waterjet Technology*, BHRA, Sardinia, Spain, 1996, pp. 725-734.
20. M. Tomoji, "A Precision Cleaning Method", Japanese Patent 04078477, 1990.
21. S. Hitoshi, "Dry Ice Blast Device", Japanese Patent 10137707 A, 1996.
22. W.S. Melvin, and J. Graham, "Method to Demilitarize, Extract and Recover Ammonium Perchlorate From Composite Propellant Using Liquid Ammonia", US Patent 4854982, 1993.
23. W.S. Melvin, "Method to extract and Recover Nitramine Oxidizers from Solid Propellants Using Liquid Ammonia", US Patent 5284995, 1994.
24. K. Babets, E. S. Geskin, "Application of Fuzzy Logic for Modeling of the Waterjet Paint Stripping ", Submitted to *An International Journal of Machining Science and Technology*, 1999.

25. I. Harima, "Ice Blasting Device and Manufacture of Ice Blasting Ice Grain", Japanese Patent 04360766 A, 1992.
26. T. Mesher, "Fluidized Stream Acceleration And Pressurizer Apparatus", US Patent 5,607,478, 1997.
27. H. Shinichi, "Surface Cleaning Method and Device", Japanese Patent 09225830 A, 1997.
28. G. Settles, "Supersonic Abrasive Ice blasting Apparatus", US Patent 5,785,581, 1997.