

Copyright Warning & Restrictions

The copyright law of the United States (Title 17, United States Code) governs the making of photocopies or other reproductions of copyrighted material.

Under certain conditions specified in the law, libraries and archives are authorized to furnish a photocopy or other reproduction. One of these specified conditions is that the photocopy or reproduction is not to be “used for any purpose other than private study, scholarship, or research.” If a user makes a request for, or later uses, a photocopy or reproduction for purposes in excess of “fair use” that user may be liable for copyright infringement,

This institution reserves the right to refuse to accept a copying order if, in its judgment, fulfillment of the order would involve violation of copyright law.

Please Note: The author retains the copyright while the New Jersey Institute of Technology reserves the right to distribute this thesis or dissertation

Printing note: If you do not wish to print this page, then select “Pages from: first page # to: last page #” on the print dialog screen

The Van Houten library has removed some of the personal information and all signatures from the approval page and biographical sketches of theses and dissertations in order to protect the identity of NJIT graduates and faculty.

ANALYSIS AND TESTS L-SHAPED
REINFORCED CONCRETE COLUMN
UNDER COMBINED BIAXIAL BENDING
AND AXIAL COMPRESSION

by

Alaedin Majlesi

Thesis submitted to the Faculty of the Graduate School of
the New Jersey Institute of Technology in partial fulfillment of
the requirements for the degree of
Master of Science in Civil Engineering
1983

APPROVAL SHEET

TITLE OF THESIS:

ANALYSIS AND TESTS L-SHAPED
REINFORCED CONCRETE COLUMN UNDER
COMBINED BIAxIAL BENDING AND
AXIAL COMPRESSION.

NAME OF CANDIDATE:

ALAEDIN MAJLESI

MASTER OF SCIENCE IN CIVIL
ENGINEERING, 1983

THESIS AND ABSTRACT

APPROVED:

Dr. C. T. Thomas HSU

Dr. F. G. Lehman

Dr. D. Raghu

DATE OF APPROVAL:

V I T A

NAME: ALAEDIN MAJLESI

DEGREE AND DATE TO BE CONFERRED: OCTOBER, 1983

<u>SECONDARY EDUCATION:</u>	<u>DEGREE</u>	<u>DATE OF DEGREE</u>
Firooz-Bahram High School	High School Diploma	1973

COLLEGIATE INSTITUTIONS ATTENDED:

Bergen Community College		1978
New Jersey Institute of Technology	BSCE	1979
New Jersey Institute of Technology	MSCE	1983

MAJOR: CIVIL ENGINEERING (STRUCTURE)

Blank Page

TO MY WIFE
and
beautiful children
Nima and Ava

	<u>Page No.</u>
ABSTRACT-----	VI
ACKNOWLEDGEMENTS-----	VII
LIST OF FIGURES-----	VIII
LIST OF TABLES-----	X
CHAPTER I INTRODUCTION AND SCOPE OF INVESTIGATION	1
INTRODUCTION AND SCOPE OF INVESTIGATION	
1.1 INTRODUCTION-----	1
1.2 SCOPE OF STUDY-----	2
1.2.1 ANALYSIS-----	2
1.2.2 EXPERIMENTS-----	2
CHAPTER II EXPERIMENTAL DETAILS	
2.1 EXPERIMENTAL TECHNIQUE-----	3
2.2 STRAIN AND CURVATURE MEASUREMENTS-----	3
2.3 MATERIAL AND FABRICATION-----	8
2.3.1 STEEL REINFORCEMENT-----	8
2.3.2 CONCRETE-----	16
CHAPTER III EXPERIMENTAL INVESTIGATION OF LOAD-DEFORMATION	
3.1 INTRODUCTION AND SCOPE-----	27
3.2 LOAD-DEFLECTION CURVES-----	27
3.3 LOAD-STRAIN CURVES-----	35
3.4 BIAXIAL MOMENT-CURVATURE CHARACTERISTICS UNDER COMBINED BIAXIAL BENDING AND AXIAL COMPRESSION-----	35
3.4.1 INTRODUCTION-----	35
3.4.2 ANALYSIS OF TEST RESULTS-----	35
3.5 CRACK PATTERNS AND FAILURE MODES-----	59

CHAPTER IV

NON-LINEAR BEHAVIOR AND CHARACTERISTICS OF L-SHAPED REINFORCED CONCRETE COLUMN UNDER BIAXIAL BENDING AND COMPRESSION-----	74
4.1 INTRODUCTION-----	74
4.2 BIAXIAL MOMENT-CURVATURE RELATIONSHIPS-----	75
4.2.1 BASIC ASSUMPTIONS-----	76
4.3 COMPUTER APPROACH-----	76
4.4 ULTIMATE STRENGTH INTRACTION SURFACE FOR MEMBERS SUBJECTED TO BIAXIAL BENDING AND AXIAL COMPRESSION-----	78
4.5 BIAXIAL MOVEMENT-CURVATURE CURVES-----	86

CHAPTER V

SUMMARY AND CONCLUSIONS-----	90
BIBLIOGRAPHY-----	91

ABSTRACT

Title of Thesis: Behavior of "L" Shape Rein

Alaedin Majlesi, Master Thesis of Structural Engineering, 1983

Dr. C. T. Thomas Asu, Department of Civil and Environmental Engineering

A total of five tests on biaxially loaded column specimens were conducted to investigate the complete behavior of load-deformation characteristics from zero load until failure. The specimens were tested under horizontal position with 60 ton hydraulic jack. Pin end was used for both ends to obtain higher accuracy of plotting curves.

Two specimens were tested with dial gages to obtain load-deflection curves and the other three specimens were tested with demec and strain gages to obtain load strain and moment-curvature curves. The strain gages were measured by weston bridge and demec-gages were measured by mechanical dial gage.

The above moment-curvature curves can be incorporated in several special purpose computer programs, which calculate the moment rotation and the load-deflection relationships for L-Shaped reinforced concrete columns under combined biaxial bending and axial compression. Calculated results were compared with the theoretical results from computer program and satisfactory agreement was obtained.

ACKNOWLEDGEMENTS

I express my deepest gratitude to Dr. Thomas Hsu. His constant encouragement and discussions contributed in large part to the development of this study. I also wish to express my deepest appreciation to Dr. Fred Lehman and Dr. Ragnu for their careful examination of manuscript and making various corrections. Most of all my college friends, Reza Taghehchian, Mehran Yekta, Mahmood Saeedi and Azim Meshkotti for continuous help throughout the experiments of his study.

The financial assistance of New Jersey Institute of Technology is gratefully acknowledged.

LISTS OF FIGURES

<u>FIGURE</u>	<u>DESCRIPTION</u>	<u>PAGE NO.</u>
2.1	End Condition-----	4
2.1a	End Condition and Bearing Plate-----	5
2.2	Self-Compensated Gage-----	7
2.3	Connection Between Wire and Strain Gage-----	7
2.4	Position of Demec Gages-----	9
2.5	Measurement of Strain Across the Cross Section-----	9
2.6	Measurement of Strain Gages (On Steel and Concrete) by Weston Bridges-----	10
2.7	Position of Demec Gages on Column after Column Failed-----	10
2.8	Strain Gages on Crete-----	11
2.9	Strain Gages on Steel in Compression-----	11
2.10	Strain Gages on Steel in Tension-----	12
2.11,a,b,c	Stress - Strain Curve of Main Reinforcement-----	13-15
2.12	Grain Size Analysis-----	18
2.13	Placing the Re-Bars into the Fomwork-----	19
2.14	Fomwork-----	19
2.15	Casting of Concrete - and Vibration-----	20
2.16	Strain Gages on Re-Bars - with Waterproofing Coat-----	20
2.17	Casted Column with Sample Cylinders-----	21
2.18	Taking Concrete Sample According to ACI Specification for Compression Test-----	21
2.19-19.a	Column Elevation-----	22 & 23
2.20	Steel Detail (Section through Bracket)-----	24
2.21	Typical Section of Column-----	25
2.22	Steel Detail of Bracket (Longitudinal Section)-----	26
3.1	Set-up of Dial Gages-----	28
3.2-3.5	Load Deflection Curve-----	29-34
3.6-3.26	Load Strain Curves-----	36-56
3.27 & 3.28	Arrangement of Demec Gages for Specimen No. 4 and No. 5-----	57
3.29 & 3.30	Arrangement of Strain Gages for Specimen No. 4 and No. 5-----	58
3.31,a	Strain Distribution Across the Section for Test #5-----	60 & 61

LIST OF FIGURES

<u>FIGURE</u>	<u>DESCRIPTION</u>	<u>PAGE NO.</u>
3.32,a	Strain Distribution Across the Section for Test #4-----	62 & 63
3.33-3.36	Moment Curvature Curves-----	64 - 67
4.1	Typical Load-Deflection and Moment Curvature Curves-----	77
4.2	Elements of Section-----	79
4.3	Intraction Surface Diagram-----	85
4.4	Tri-Dimensional Model of Intraction Surface of an "L"Shape Section-----	86
4.5	Typical Isoload Design Chart-----	88
4.6	Flow Diagram-----	89

LISTS OF TABLES

PAGE NO.

2.1-2.2	Sieve Analysis -----	17
4.1	Area and Coordinates of Elements -----	80-84

INTRODUCTION AND SCOPE OF INVESTIGATIONS

CHAPTER I

1.1 INTRODUCTION

Reinforced Concrete is a building material that permits the designer considerable latitude in the selection of form of structural elements. The shape of elements in a reinforced concrete structure may be used to optimize its structural strength. To make a better use of available space, to improve the esthetic appearance of the structure or to facilitate construction.

Rectangular and circular cross sections columns have been used since reinforced concrete was introduced as a structural material at the end of last century. Thus, the strength of these sections has been widely studied as design aids (15) are readily available to determine the load carrying capacity of these columns. If cross sections other than the rectangle or the circle are used, the designer must determine the strength of the section, because there are very few design aids available to cover these sections. Information on the deformation characteristic and behavior of irregular reinforced concrete is substantially less. Furthermore, most of the information available are basically the ultimate strength and interaction surface diagram of column. (See references)

The purpose of this investigation, therefore, is aimed at obtaining more detailed information regarding load deformation characteristics and ultimate strength of irregular reinforced concrete column. Also, this information can be found useful for the limit analysis of reinforced concrete space frames.

1.2 Scope of Study

1.2.1 Analysis

The computer program developed by Hsu (1) is able to use any standard reinforced concrete section geometry and material property. This computer program also gives the information for the stress and strain distribution across the section, the ultimate strength and interaction surface of biaxially loaded short column, and also the program can calculate the load deformation and moment curvature curve from zero to the maximum moment capacity.

1.2.2 Experiments

A total of 5 specimens with 1/4 scale irregular reinforced concrete columns will be tested under monotonic loading. The parameters studies are the loading history, the steel percentage and stirrup spacing.

The test specimens are to be designed as short, tied columns with an under reinforced "L" section according to the 1977 ACI Building Code. Two loading brackets are to be provided at each column end to assist with the application of Biaxially Eccentric Loads. In all tests, loads, curvatures, and central deflection of the column specimens will be recorded continuously. Applied load is to be monitored with pressure gages. The curvatures, and central deflection will be measured with strain gages, Demec Gages respectively.

All test results will be compared with the analytical model developed by Hsu (1).

EXPERIMENTAL DETAILS

CHAPTER II

2.1 Experimental Technique

The test specimens were designed as short tied columns with reinforced "L" sections. The test facilities were designed and were available by New Jersey Institute of Technology Structural Laboratory. The design of development length were based on 1977 Code, and brackets were heavily reinforced to prevent any possibility of bracket failure. To prevent bearing failure, a plate with 1 inch thick was provided at each end of the columns. At two round swivel heads were used for the end conditions with two plate 2 inches thick of three inches diameter, and a 3/4 inch ball was used in between. The plates were manufactured as such that the ball fits in between and makes a clear distance of 1/2 inches. The plates, which were in contact with the column, were also made with slightly larger diameter (1/8 inch), which allow the column to rotate freely in all directions with less friction. (See Figure 2.1 and 2.1A). This arrangement provides an applied concentration load on the column and a perfect pin-ended condition.

2.2 Strain and Curvature Measurements

Two methods were used for the measurements of strains and curvatures at a critical section in this investigation: One is the "strain gauge method" in which the strain gauges are installed over a small finite length across the section, then the curvatures can be obtained from the strain distributions along the and axes in the section. It has been found that strain

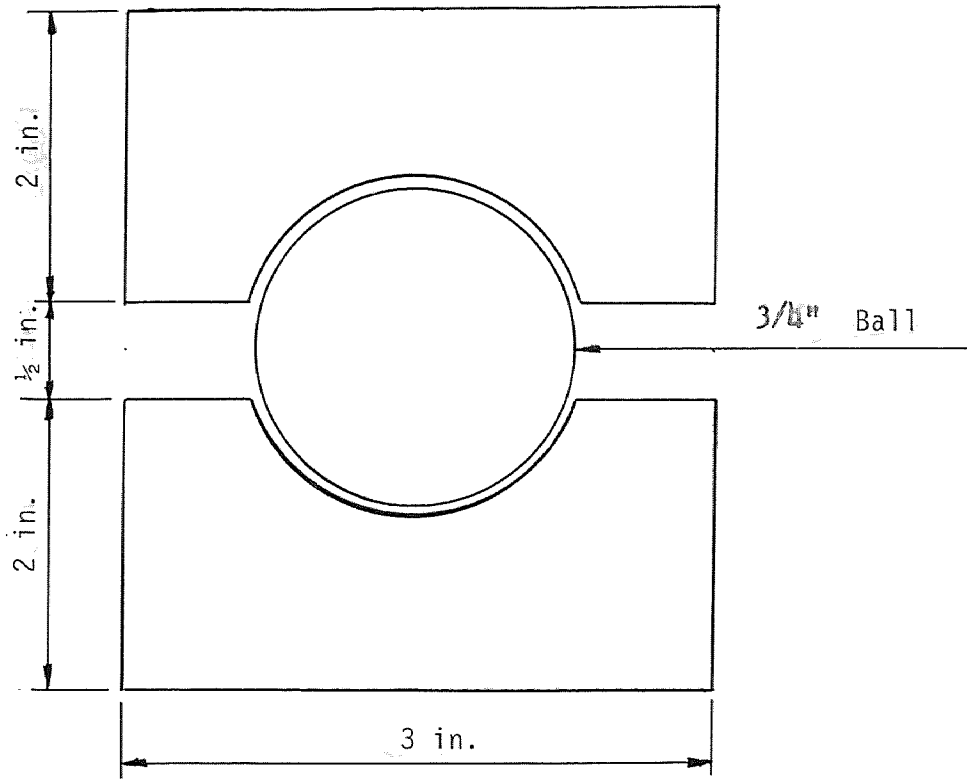

FIG. 2.1 - SWIVEL PIN END

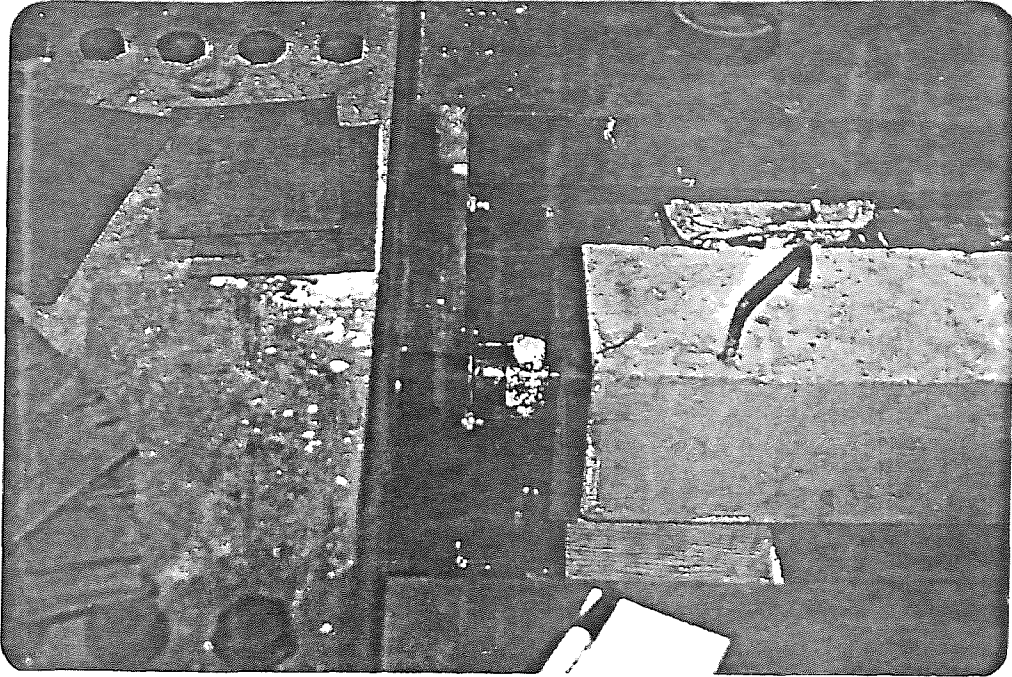

Figure 2.1A - End Condition and Bearing Plate

distribution along the axis is linear for most of the loading steps until a stage when the tension cracks gets wider or the reinforcing steel has yielded or when the concrete starts to crush on the compression side. Beyond this stage it is difficult to obtain strain values because of the local damage. It should be noted that the strain values obtained by strain gauges on the compression side of the section have been found in the present tests to be more useful than those obtained on the tension side.

The self compensated strain gauges circuit has been used. When dealing with the self compensated strain, it is unnecessary to employ a compensating gauge except in unusual circumstances. The simplest circuit for the self compensated gauges would be that shown in Figure 2.2. This is the so-called "Three-Wire" method of resistance measurement, which shows the self compensated gauge "G" connected to the measuring circuit by three lead wires d, e and f. Again d and e are equal and subjected to the same temperature throughout their length. Resistance R_1 is made approximately equal to G, and Resistance R_2 are of any convenient magnitude. Lead wire f can be different in resistance from d and e and need not to be subjected to the same temperature, although it is generally run along with them. It will be seen that the arrangement of Figure 2.2 put the resistance of leads d and e into adjacent arms of the bridges, and lead f is external to the bridge in series with battery. The result is that all of the lead wires can be subjected to wide resistance variation due to temperature and still produce negligible error in the strain gauge reading. This is a very valuable circuit for use with self compensated strain gauge and should be employed. The detail of the connection between wire and strain gauge can be shown in Figure 2.3.

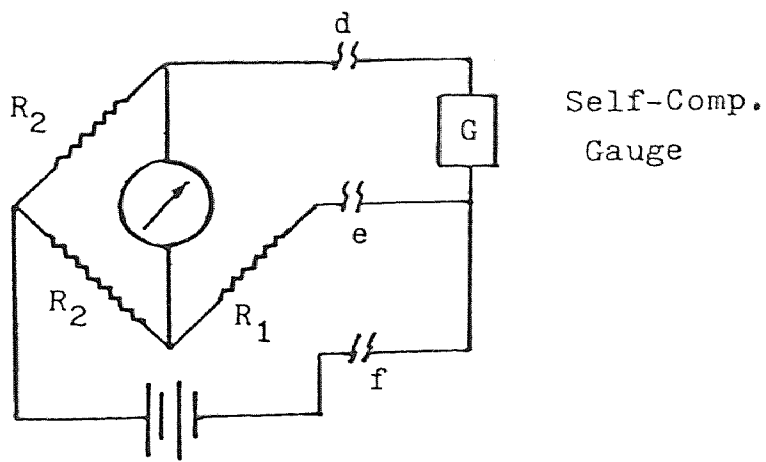

FIG. 2.2 SELF-COMPENSATED STRAIN GAUGE CIRCUIT -
THREE-WIRE METHOD

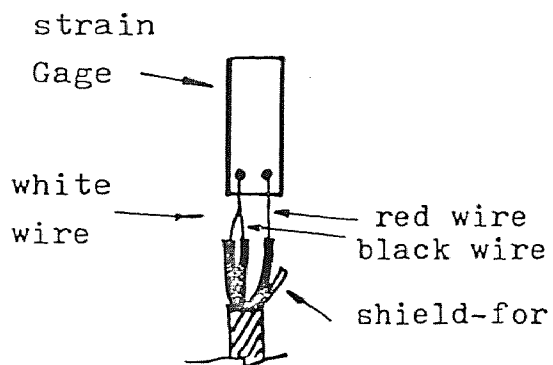

FIG. 2.3 THE ARRANGEMENT OF STRAIN GAUGE AND LEAD WIRE

Another method to obtain strains and curvatures is the so-called "Demec Gauge Method" in which the strain was calculated from measured deformation between two Demec points. The curvature can then be calculated from these strain values from the pairs of Demec gauges in x and y axes.

Photos 2.4 through 2.10 show the arrangement of strain and Demec gauges. Also the measurement devices are shown.

2.3 Material and Fabrication

2.3.1 Steel Reinforcement

The intermediate grade No. 3 deformed bar (Diameter = 0.375 inches, Area = 0.11 inches) used for the main and bracket reinforcement was obtained in straight pieces from a local supplier. The main reinforcement and stirrups were carefully bent to the required sizes with standard bar benders. Ordinary steel wire was used to hold the main reinforcement and stirrups together.

Strain gauges installed on steel bars at mid-span were carefully waterproofed according to standard procedures. Type EA-06-250BG-120 strain gauges with a gauge length of 5 mm were used on steel reinforcing bars.

The tensile test result for main Reinforcement Bar No. 3 has been shown in Figure 11. The bar was tested in Tinus Olsen #8 Hydraulic Machine at strength of material laboratory of New Jersey Institute of Technology. The strains were calculated from deformation over a gauge length of 2 inches. In such cases logs were removed on one side of bar over a length of about 1 inch at mid-span of test specimen in order to place strain gauge.

It was found that yield point and ultimate strength were little affected by the local removal of logs.

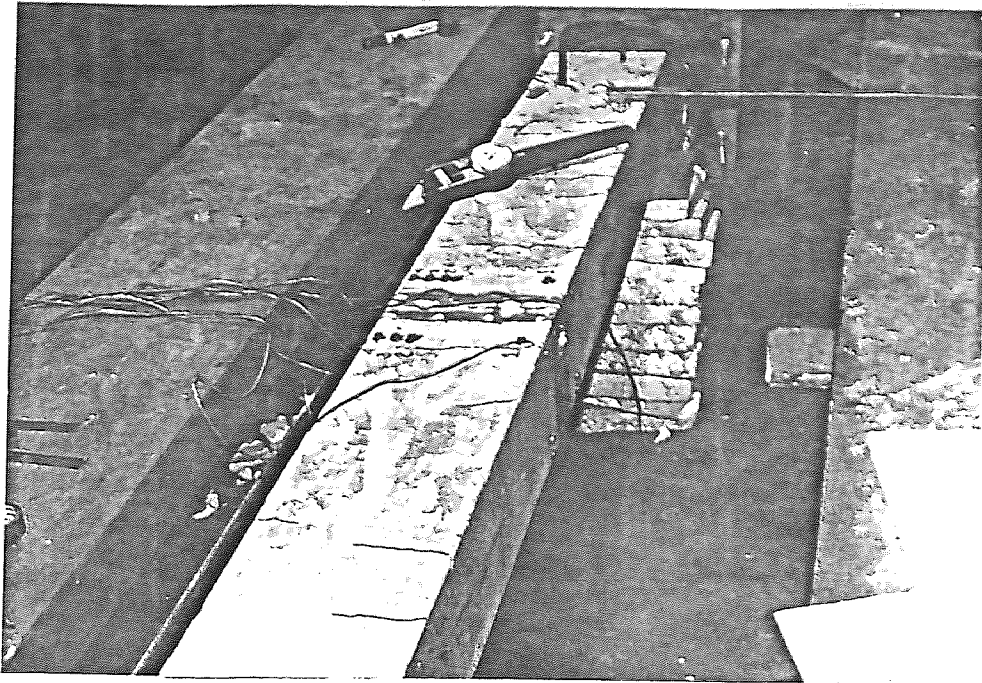

Figure 2.4 - Position of Demec Gages

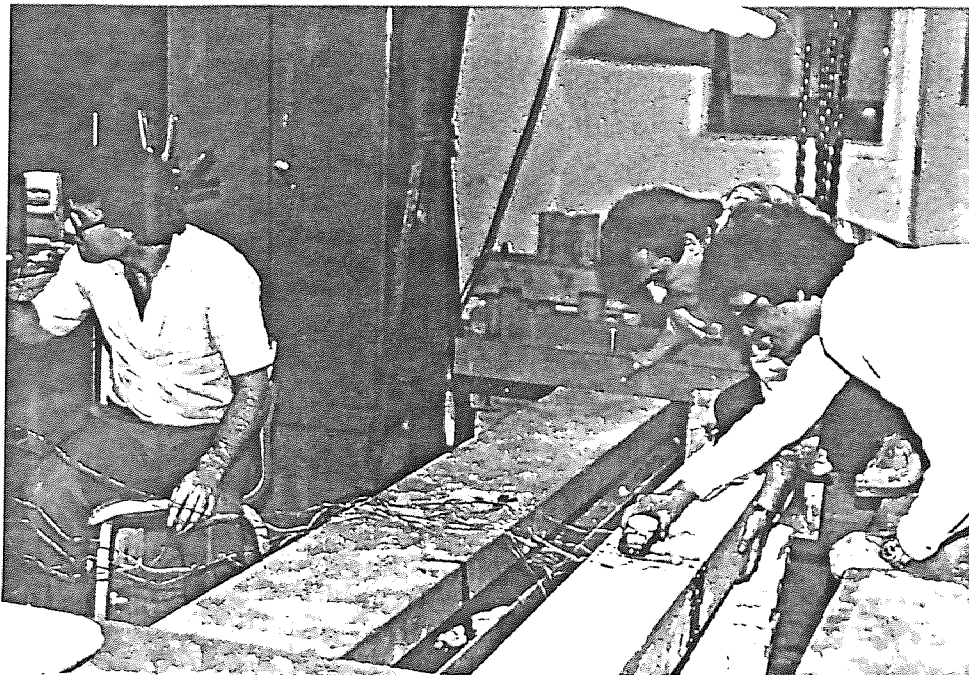

Figure 2.5 - Measurement of Strain Across the Cross-section.

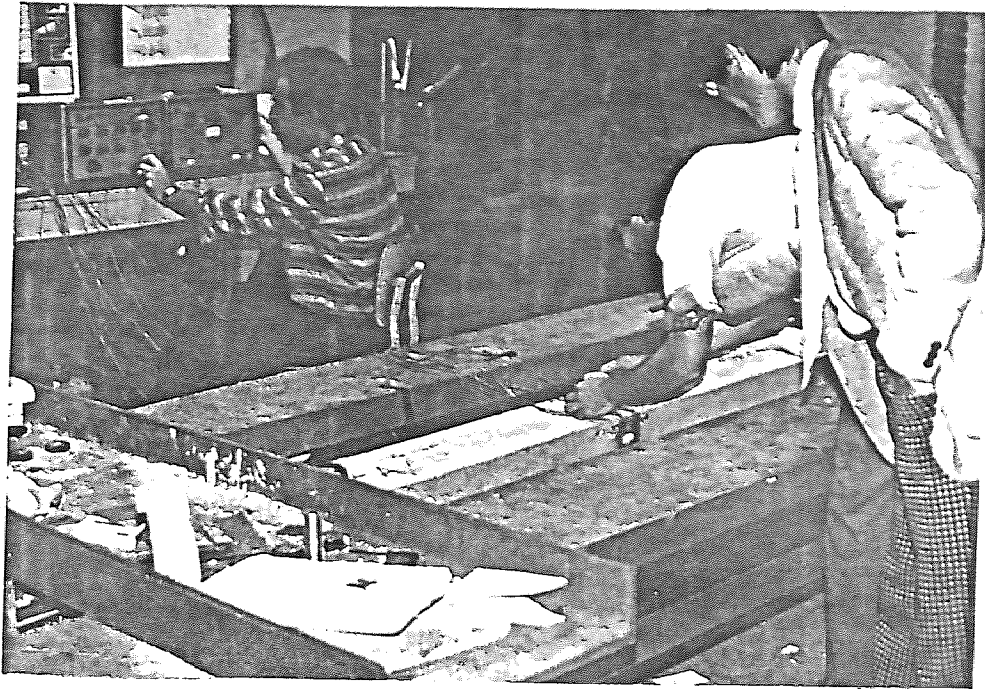

Figure 2.6 - Measurement of Strain Gages (on steel and concrete) by Weston Bridges.

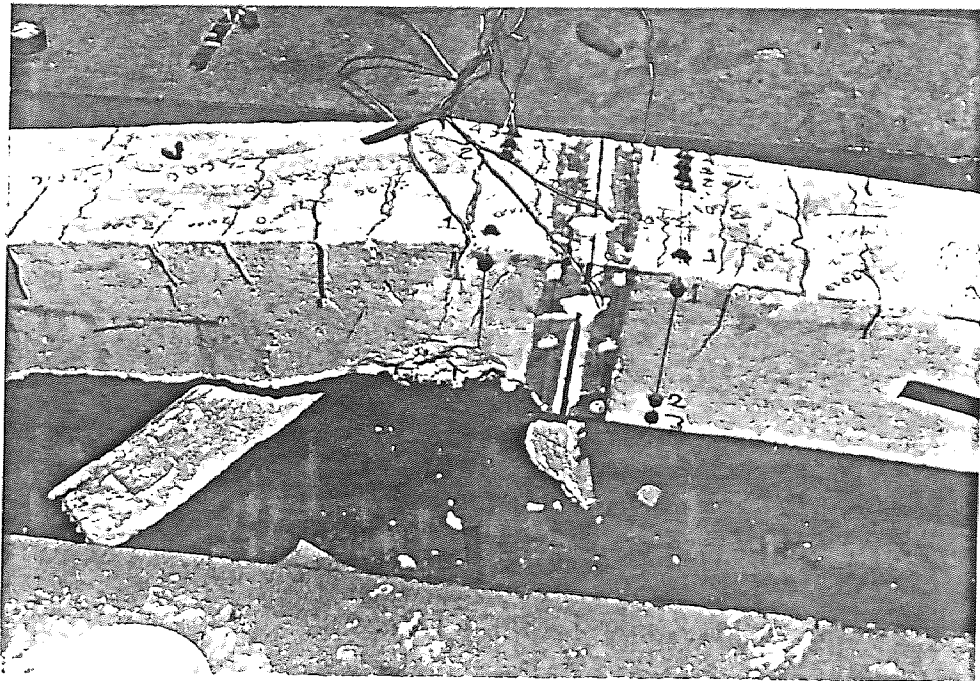

Figure 2.7 - Position of Demec Gages on Column after Column failed.

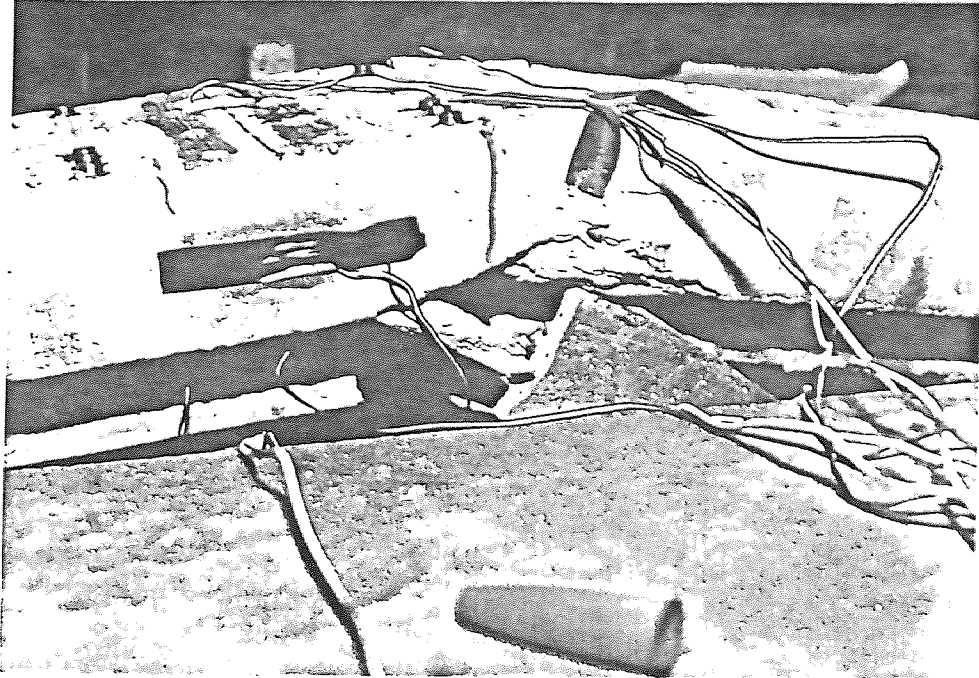

Figure 2.8 - Strain Gages on Concrete.

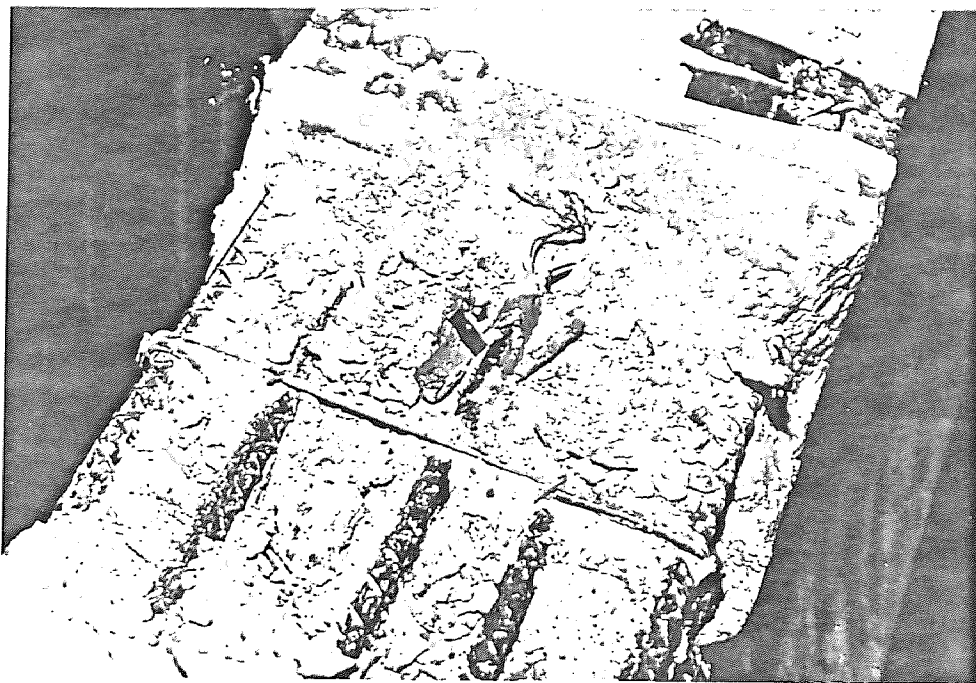

Figure 2.9 - Strain Gages on Steel in Compression.

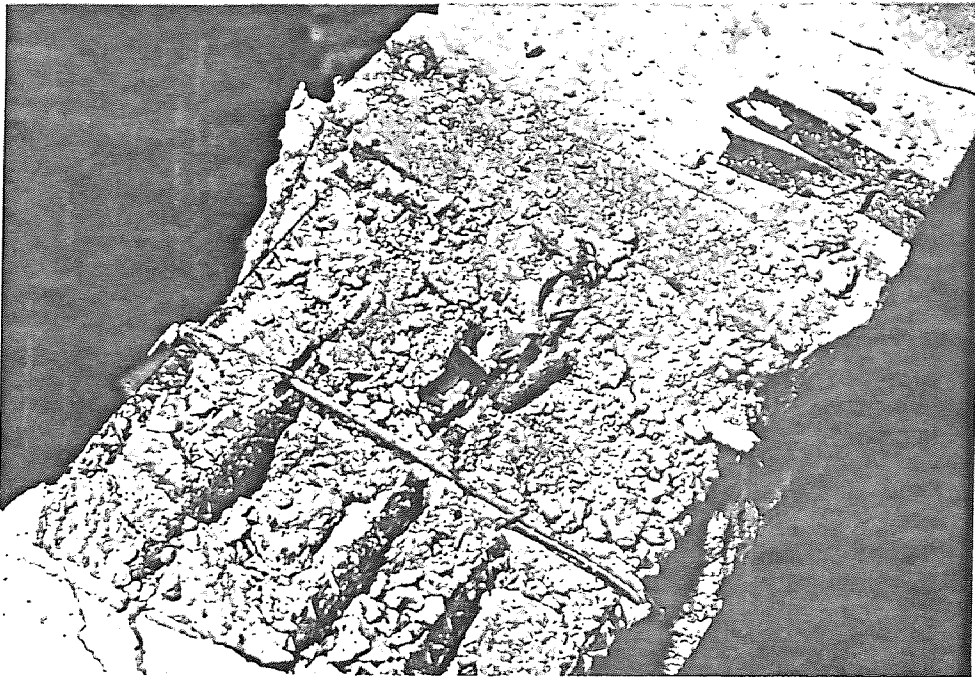
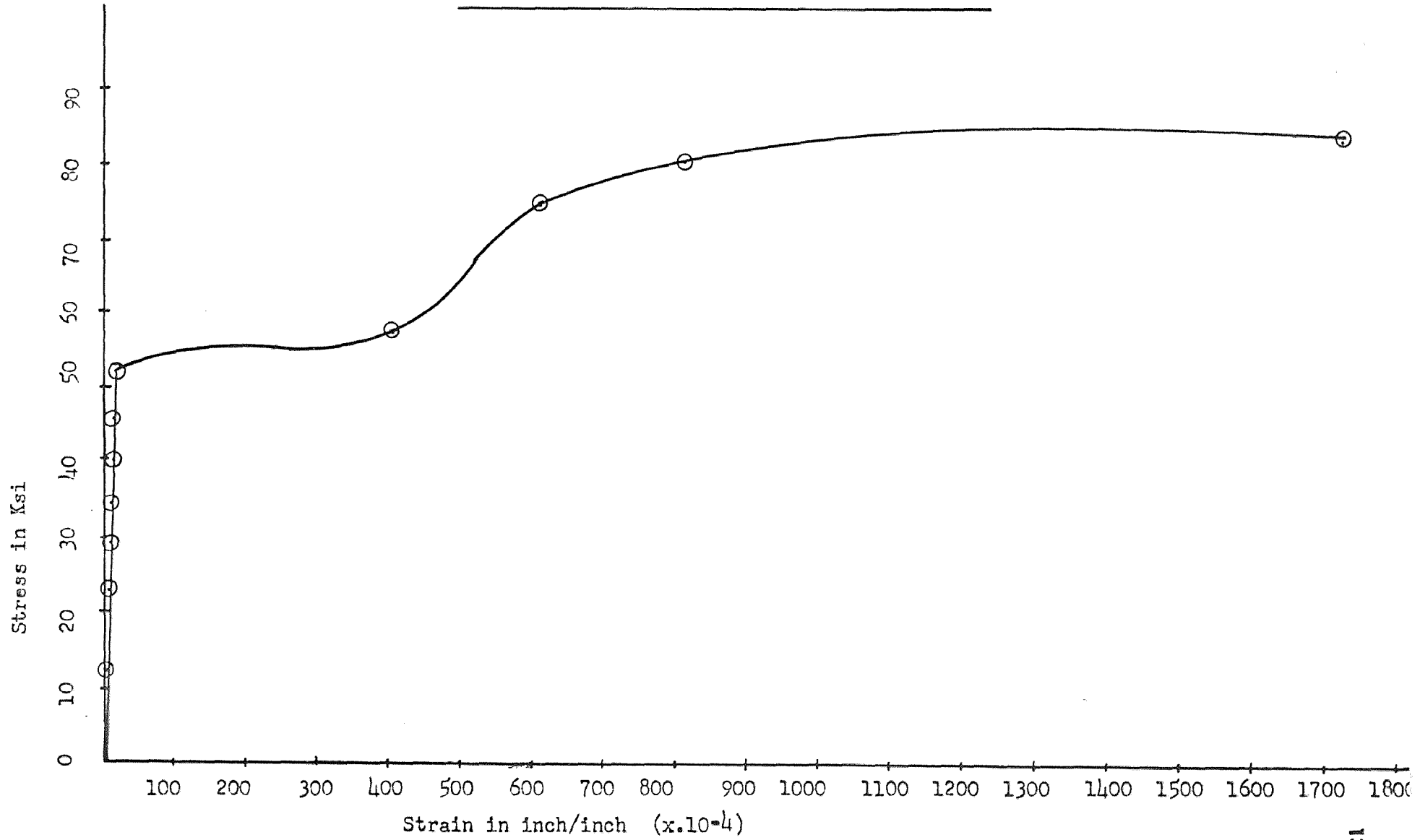

Figure 2.10 - Strain Gages on Steel in Tension

After Failure

FIG. 2-11 STRESS - STRAIN CURVE

MAIN REINFORCEMENT BAR NO. 3



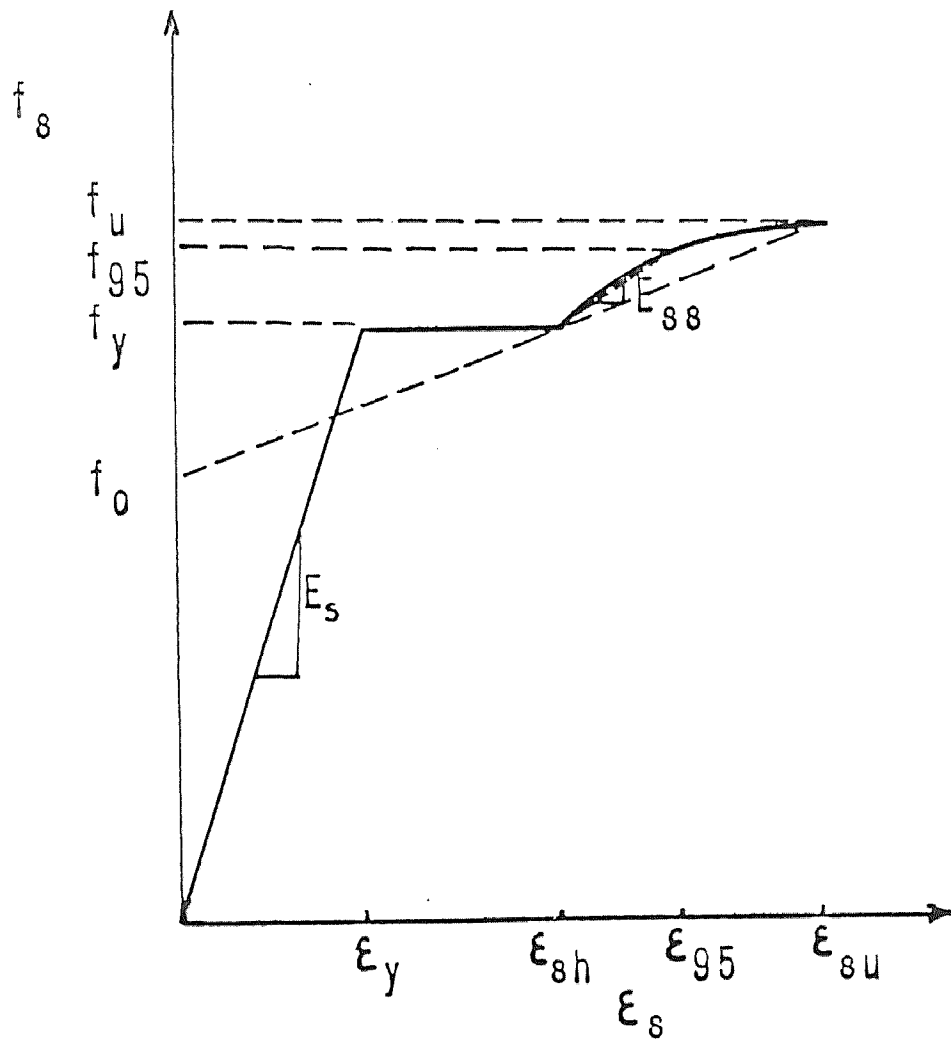

(a) Experimental Curve

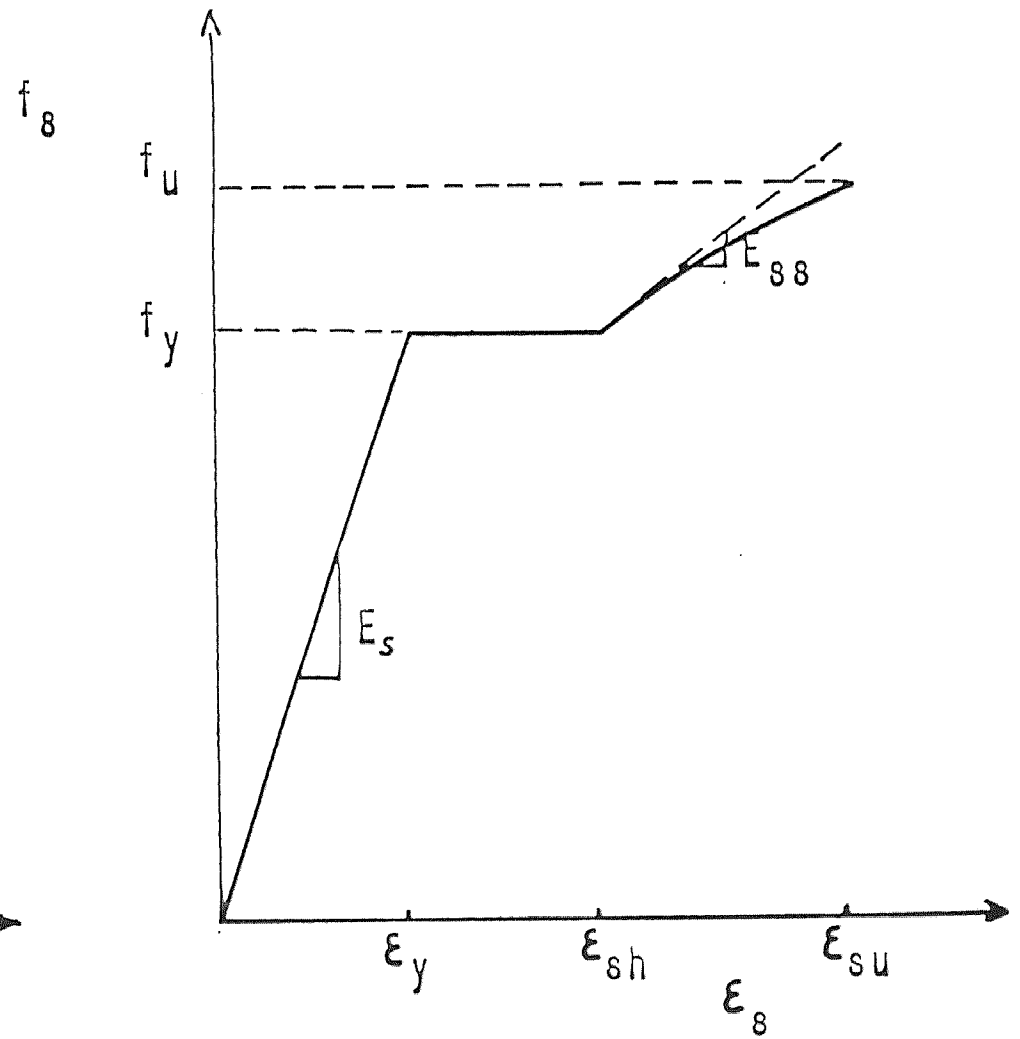

(b) Idealized Curve

FIG. 2.11A STEEL STRESS-STRAIN CURVES

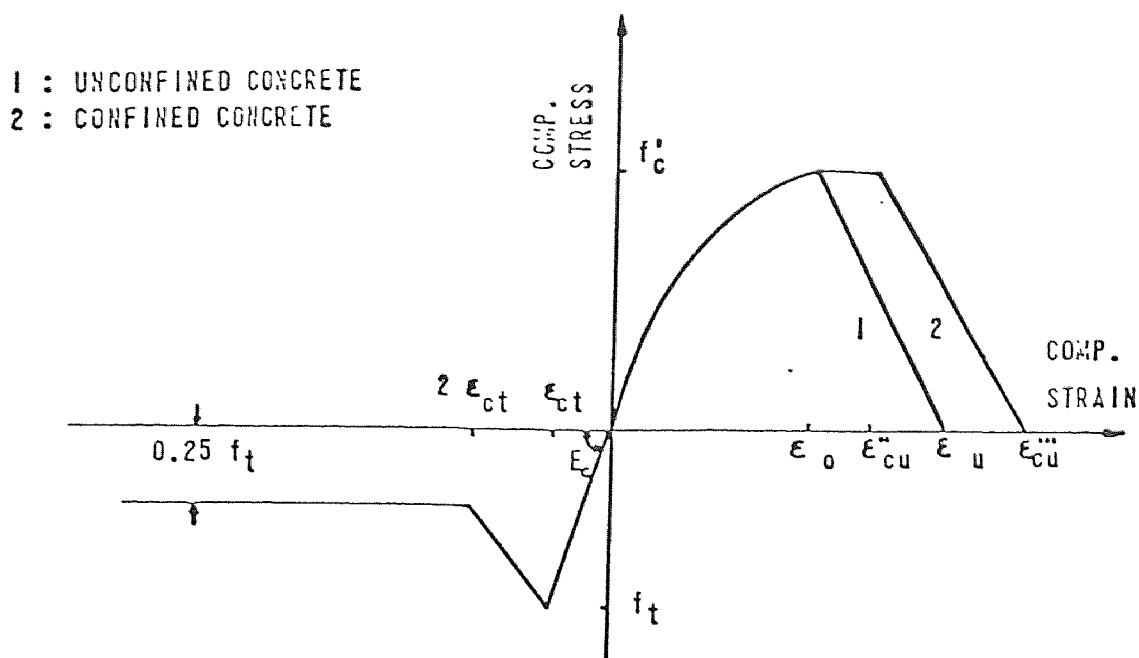

FIG. 2.11B IDEALIZED STRESS-STRAIN CURVES FOR CONCRETE

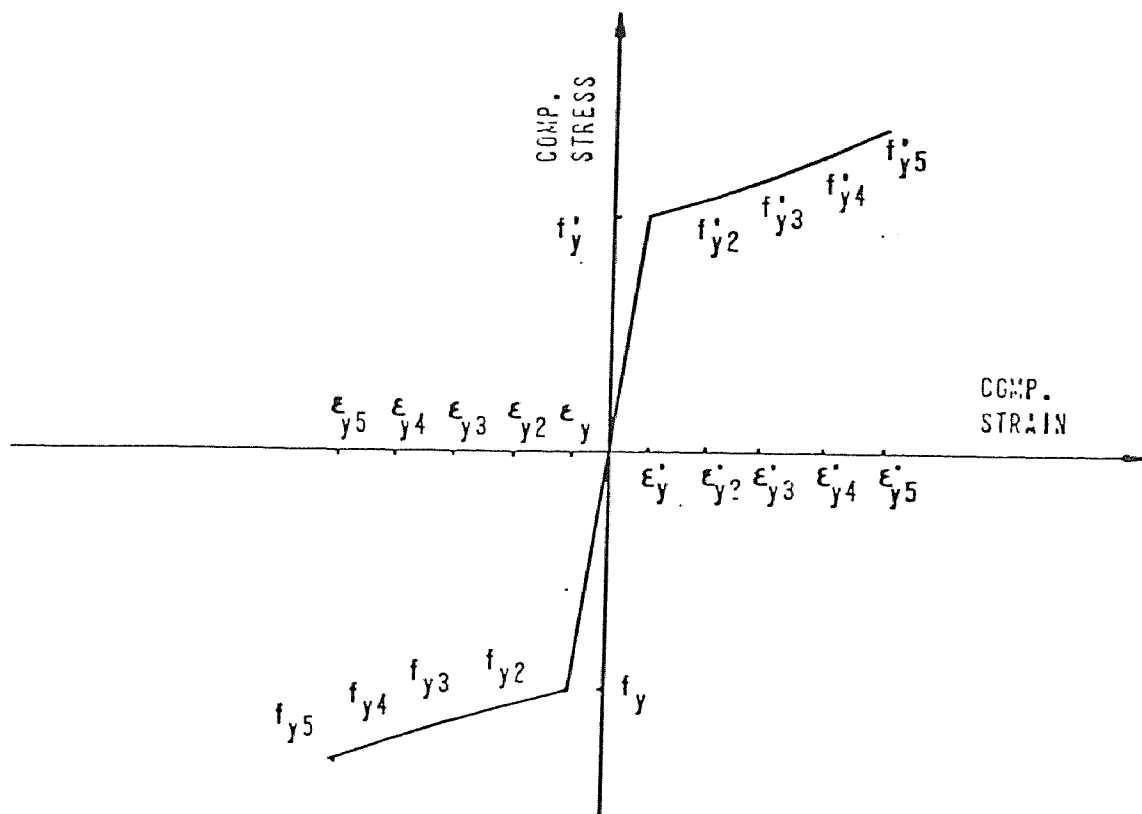

FIG. 2.11C IDEALIZED STRESS-STRAIN CURVE FOR STEEL

2.3.2 Concrete

Concrete cylinders of size 3 x 6 inches were manufactured and tested according to the standard practice.

The cylinders were cast and cured under conditions identical to those of the column test specimens and were tested at the same age.

The following mixes were used in this investigation. All proportions specified are by weight. The ratios of water and cement and aggregate and cement were 0.8 and 3.20 respectively. High early strength cement (Type III) was used in this investigation. (See Table 2.1, 2.2). Total weight of mixture per batch is as follows:

Cement = 262.54 lb.

Water = 212.56 lb.

Sand = 1024.88 lb.

2.3.3 Formwork and Casting

The test specimens were cast in horizontal position in 3/4 inch thick plywood. (See Figure 2.13 and 2.14).

This kind of casting was found to be more practical for a heavily reinforced column which made casting in a vertical position rather difficult. While a horizontal casting causes a strength differential across the column cross section, vertical casting, on the other hand, will cause a differential in concrete quality along the column length. Such a differential exists in a vertical cast column because the concrete in the bottom part generally is compacted better than that in the top part.

NEW JERSEY INSTITUTE OF TECHNOLOGY
NEWARK COLLEGE OF ENGINEERING
DEPARTMENT OF CIVIL AND ENVIRONMENTAL ENGINEERING

SOIL MECHANICS LABORATORY

Date 11/21/81 Section Instructor Dr. Hsu Exp. No. 1
Group 1 Group Members Yekta-Majlesi-Tagehchian-Meshkooti-Saeed:

SIEVE ANALYSIS

Sieve No.			10	40	70	200	Pan			
Sieve Opening (mm)			2.00	420	212	.074	-			
Mass Sieve (gm)			665g	561 g	3380	507g	490			
Mass Sieve + Soil (gm)			755g	1756g	600g	693g	510			
Mass Soil Retained (gm)			90	1195	262	186	20			
% Retained			5.1%	68.2%	14.95%	10.6%	1.15%			
Cumulative % Retained			5.1%	73.3%	88.25%	98.85%	100%			
% Finer Than			94.9%	26.7%	11.75%	1.15%	0			

$$90 + 1195 + 262 + 186 + 20 = 1753$$

SOIL SAMPLE NO.

Soil Sample Mass	
Mass Container + Dry Soil (gm)	2097g
Mass Container (gm)	344g
Mass Dry Soil (gm)	1753g

is
9/18/75

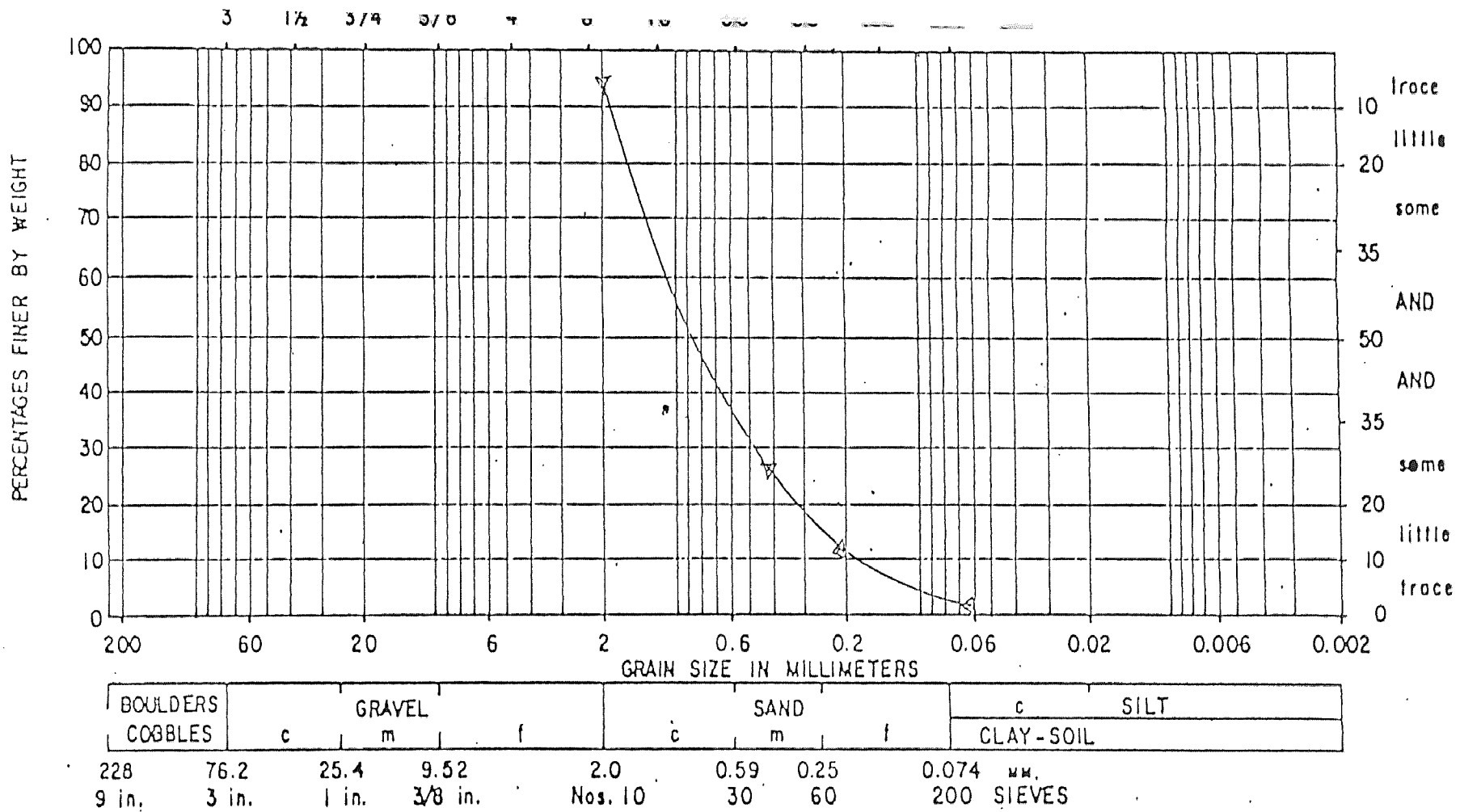

Figure 2.12

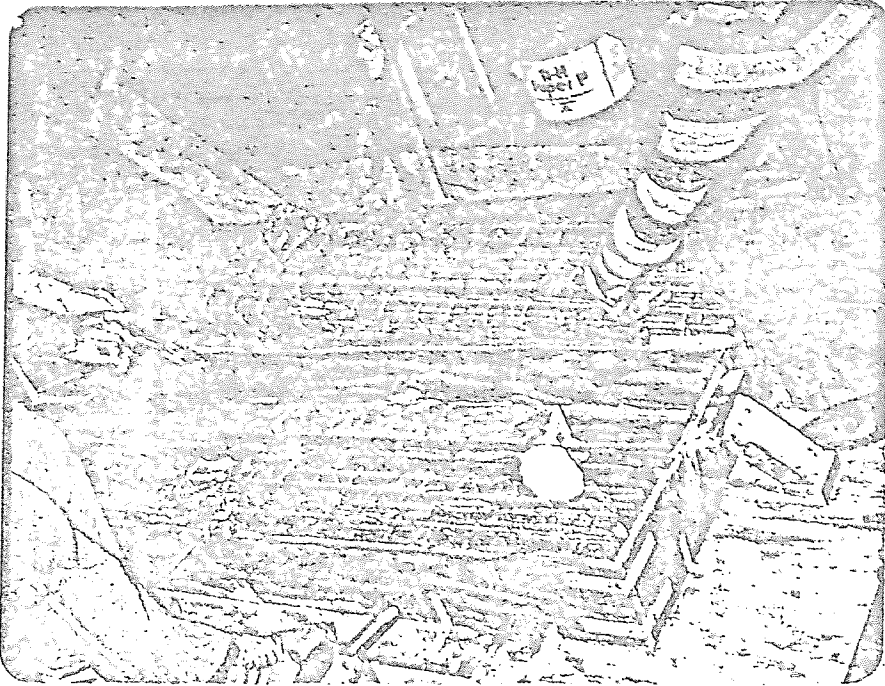

Figure 2.13 - Placing the Re-bars into the Formwork.

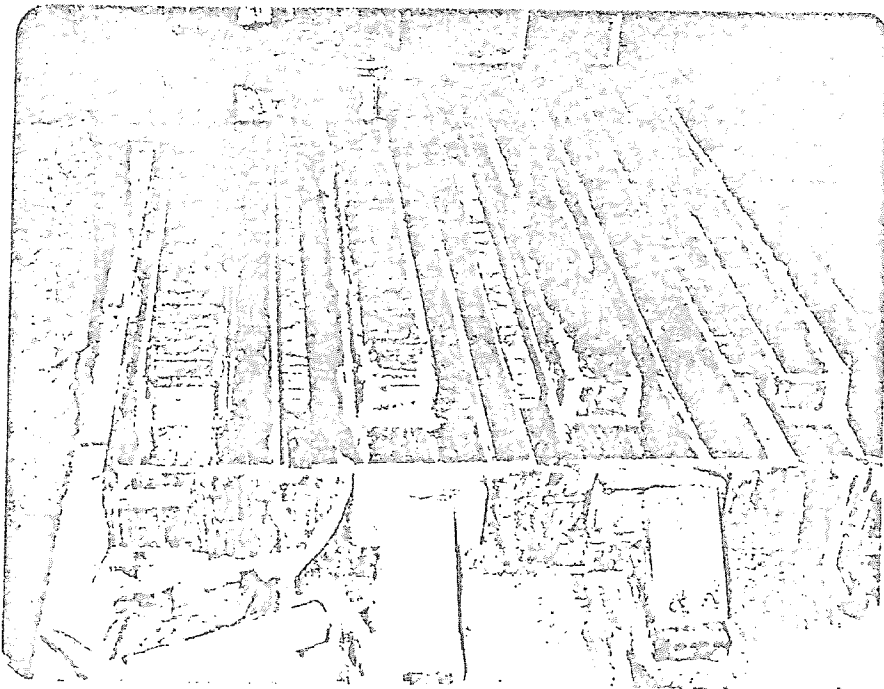

Figure 2.14 - Formwork

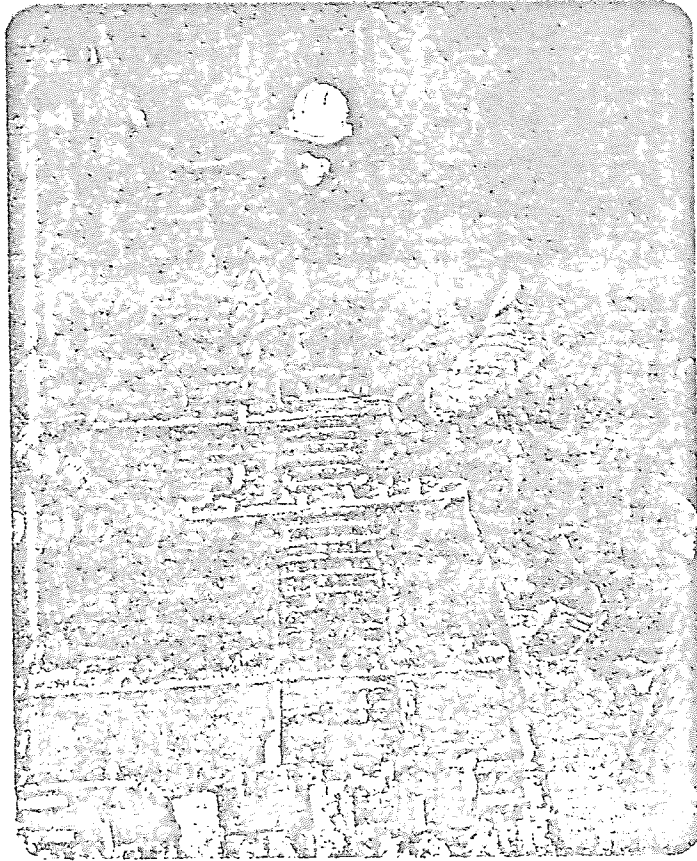

Figure 2.15 - Casting of Concrete -
and Vibration.



Figure 2.16 - Strain Gages on Re-bars -
with Waterproofing Coat.

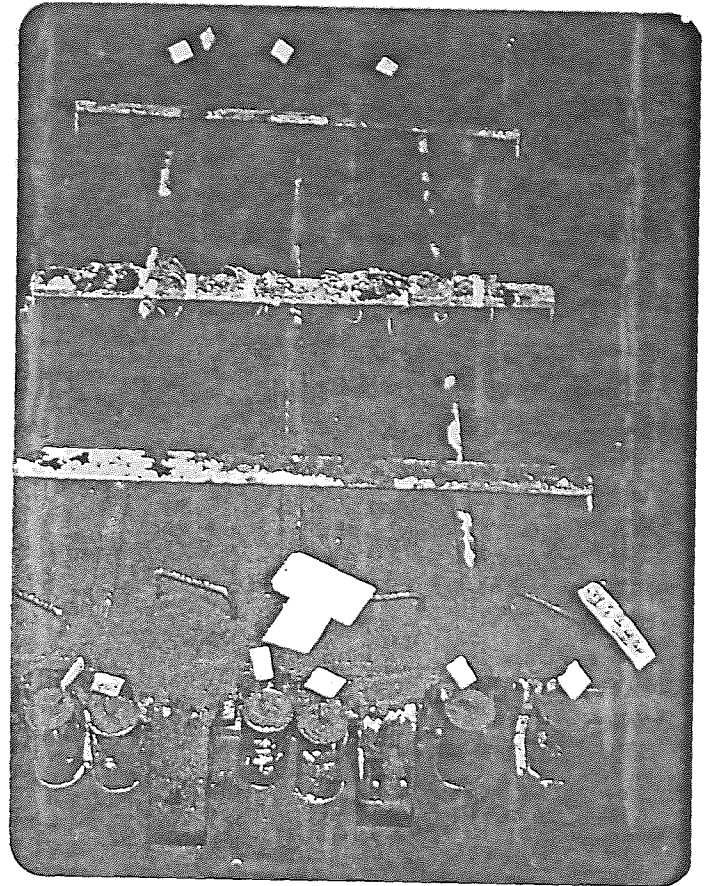
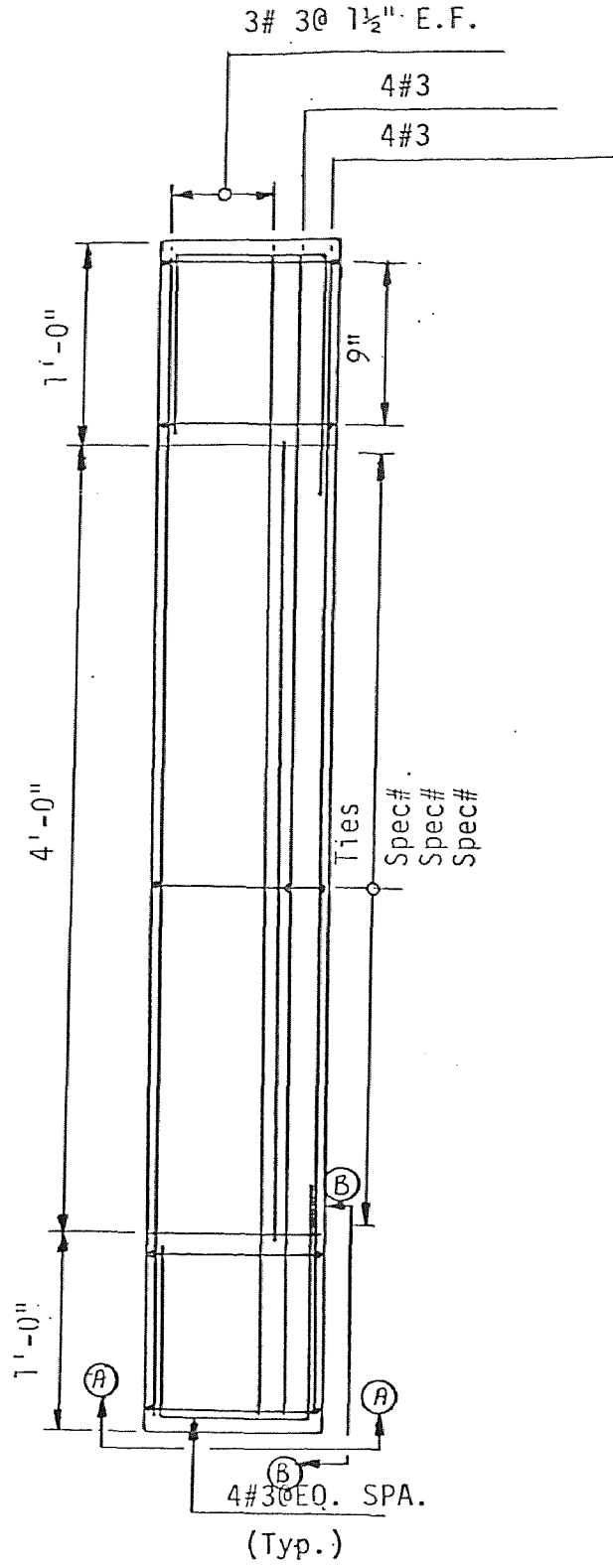

Figure 2.17 - Cast Column with Sample Cylinders



Figure 2.18 - Taking Concrete Sample According to ACI Specification for Compression Test.



Column Elevation

FIGURE 2.19

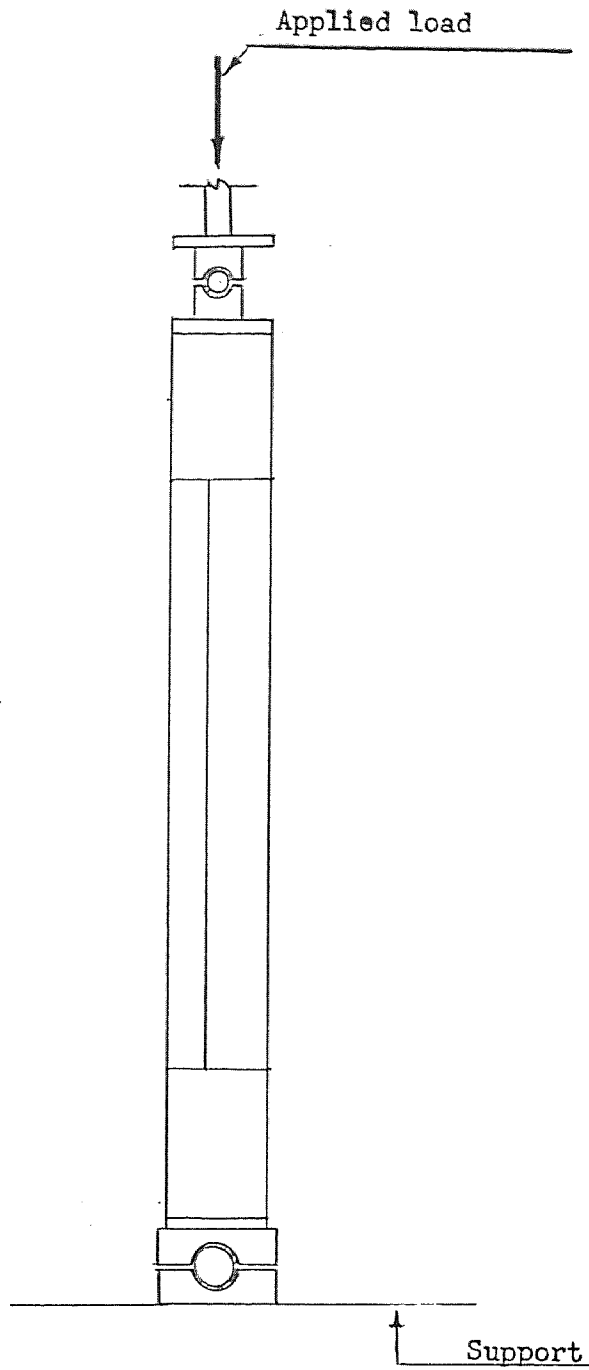
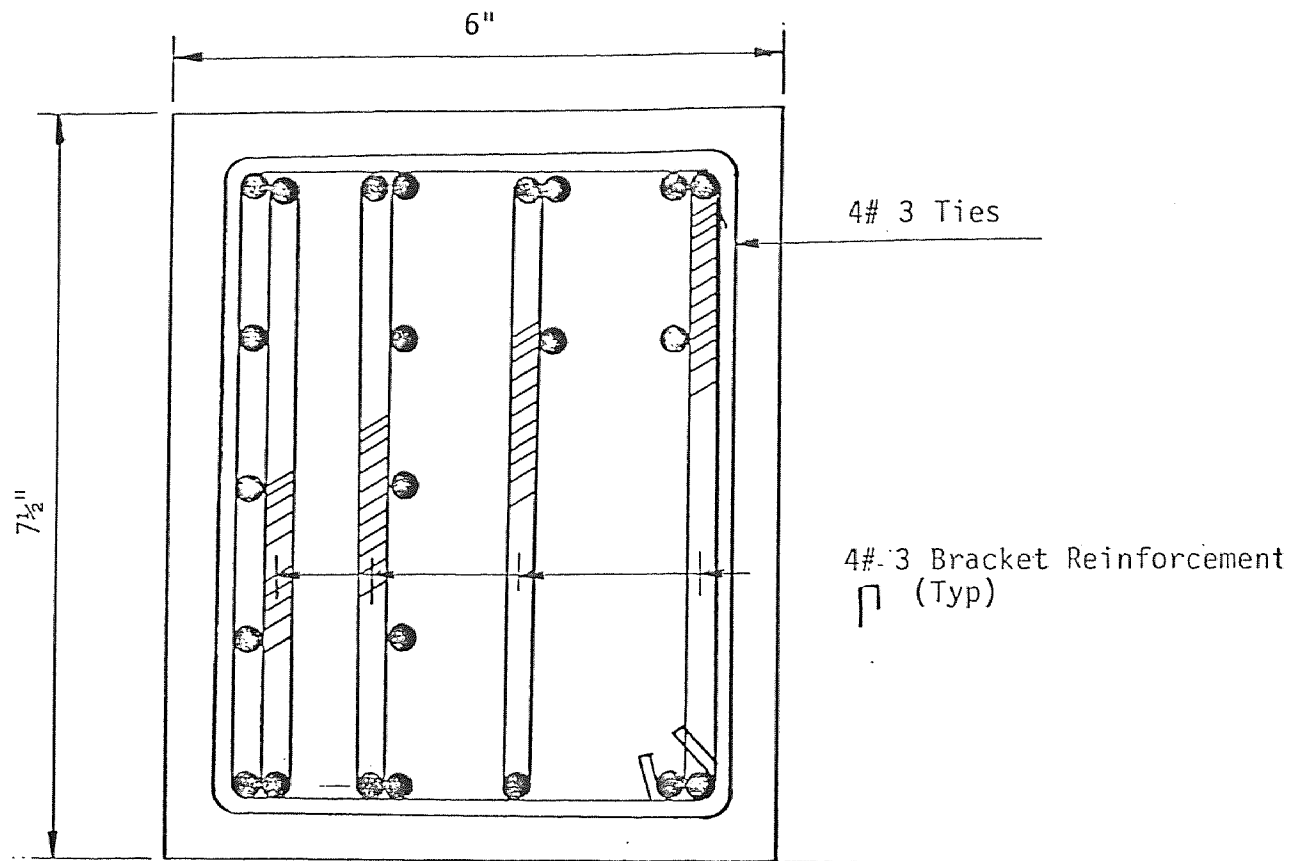

Fig. 2.19a

Beam set up in horizontal
Position



Section A-A

FIGURE 2.20

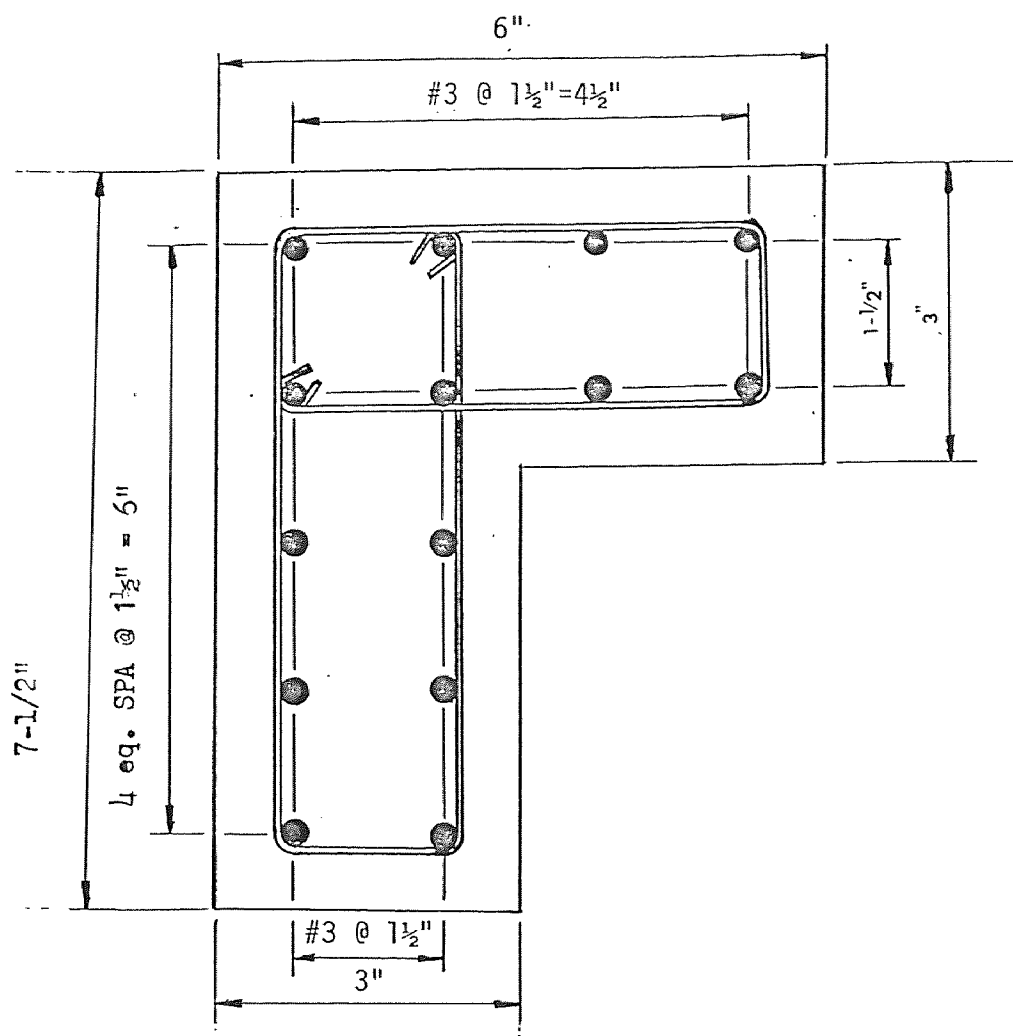

Typical Section of Column

FIGURE 2.21

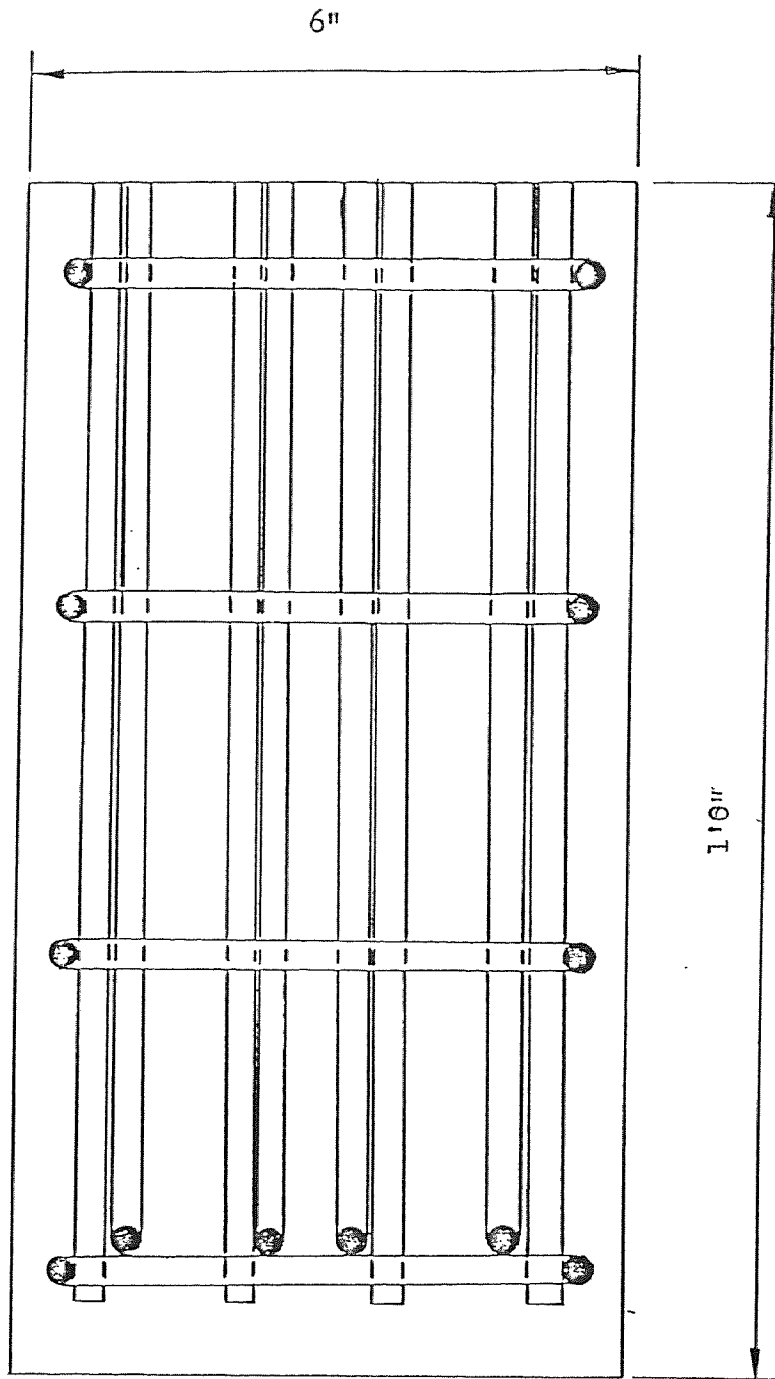

Section B-B

FIGURE 2.22

EXPERIMENTAL INVESTIGATION OF LOAD-DEFORMATION
OF L-SHAPED REINFORCED CONCRETE COLUMN UNDER
BIAXIAL BENDING AND COMPRESSION

CHAPTER III

3.1 Introduction and Scope

Information on the behavior of irregular reinforced concrete columns under biaxially eccentric loads is relatively less. Therefore, this investigation was aimed at obtaining more detailed information regarding the general behavior (Complete load-deformation characteristics from zero to ultimate) and ultimate strength of biaxially loaded irregular shaped columns. These results can be useful in the Limit Analysis Studies of three dimensional reinforced concrete frames. Also, the experimental results can be compared with results from computer program to assess the accuracy of the computer program developed.

3.2 Load-Deflection Curves

Two specimens were designed as short tied column (Stirrup spacing of 4 inches) and tested deflection was measured by two mechanical dial gages which were set at mid-span. Figures 3.2 through 3.5 show the experimental biaxial load deflection curves.



Figure 3.1 Dial Gage Set-up

FIG. 3-2 LOAD- DEFLECTION CURVE

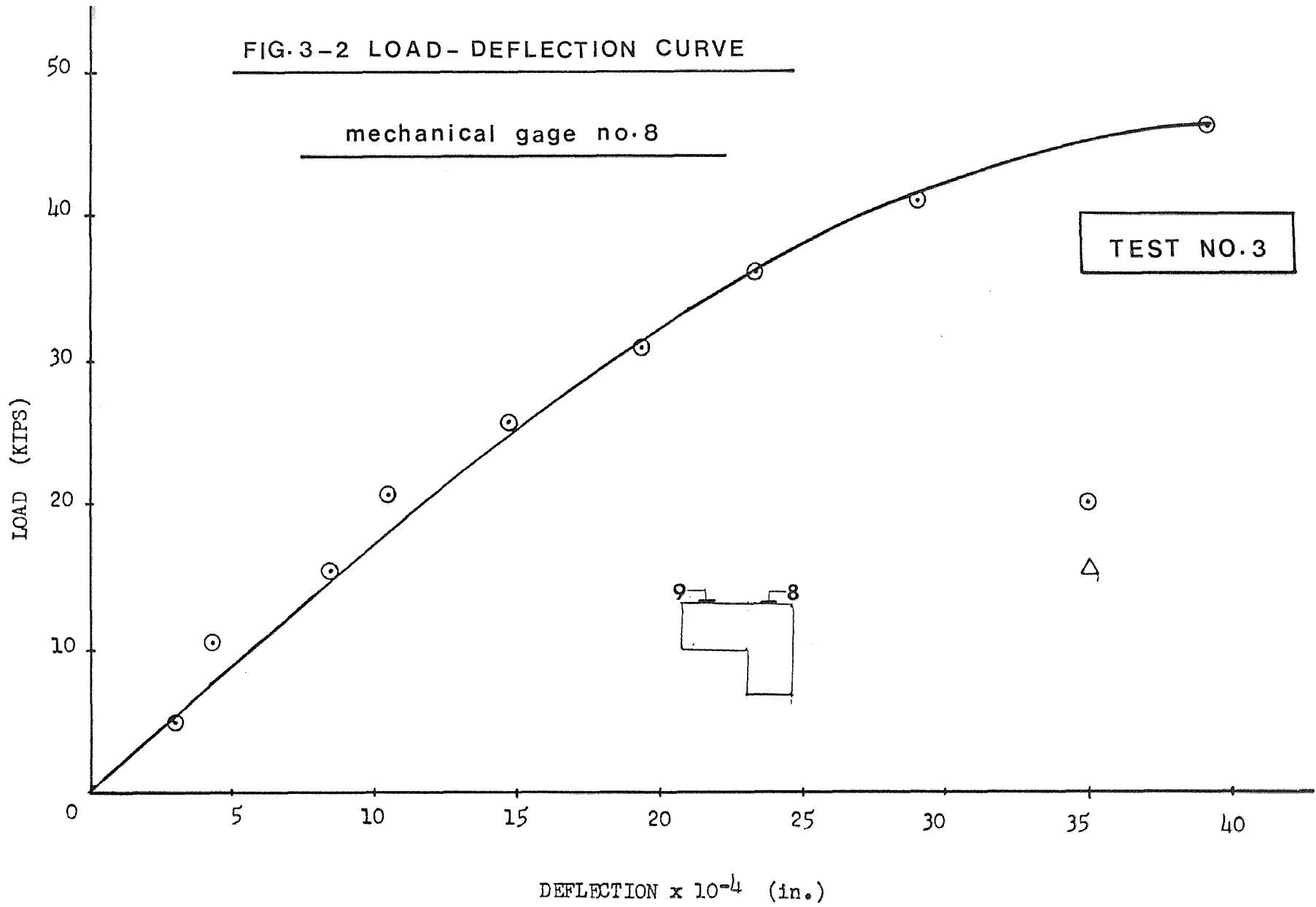

FIG. 3-2.a LOAD-DEFLECTION CURVE

mechanical gage no.9

TEST NO. 3

LOAD (KIPS)

DEFLECTION $\times 10^{-4}$ (in.)

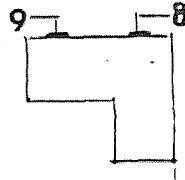

○

△

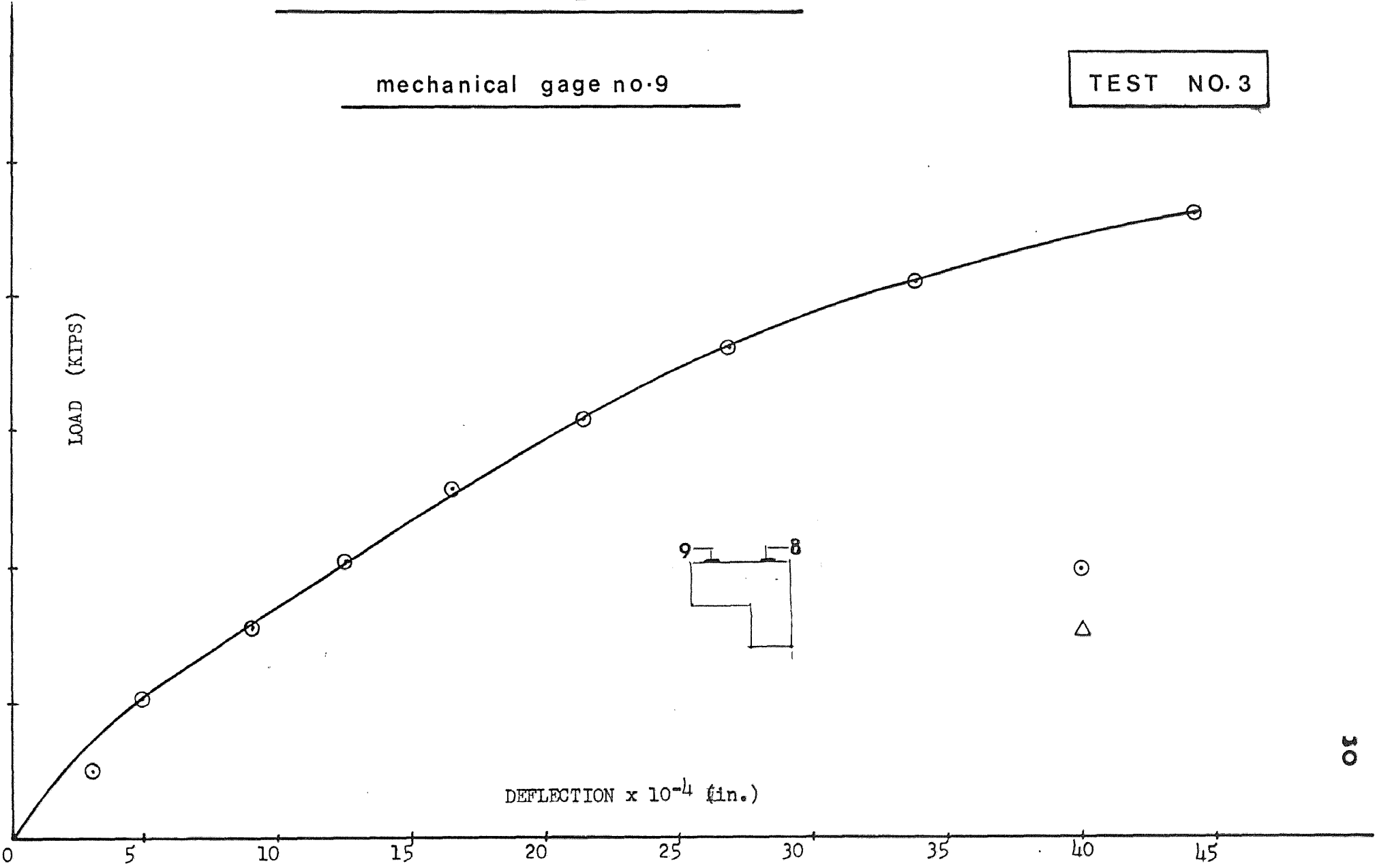

FIG. 3-3 LOAD - DEFLECTION CURVE

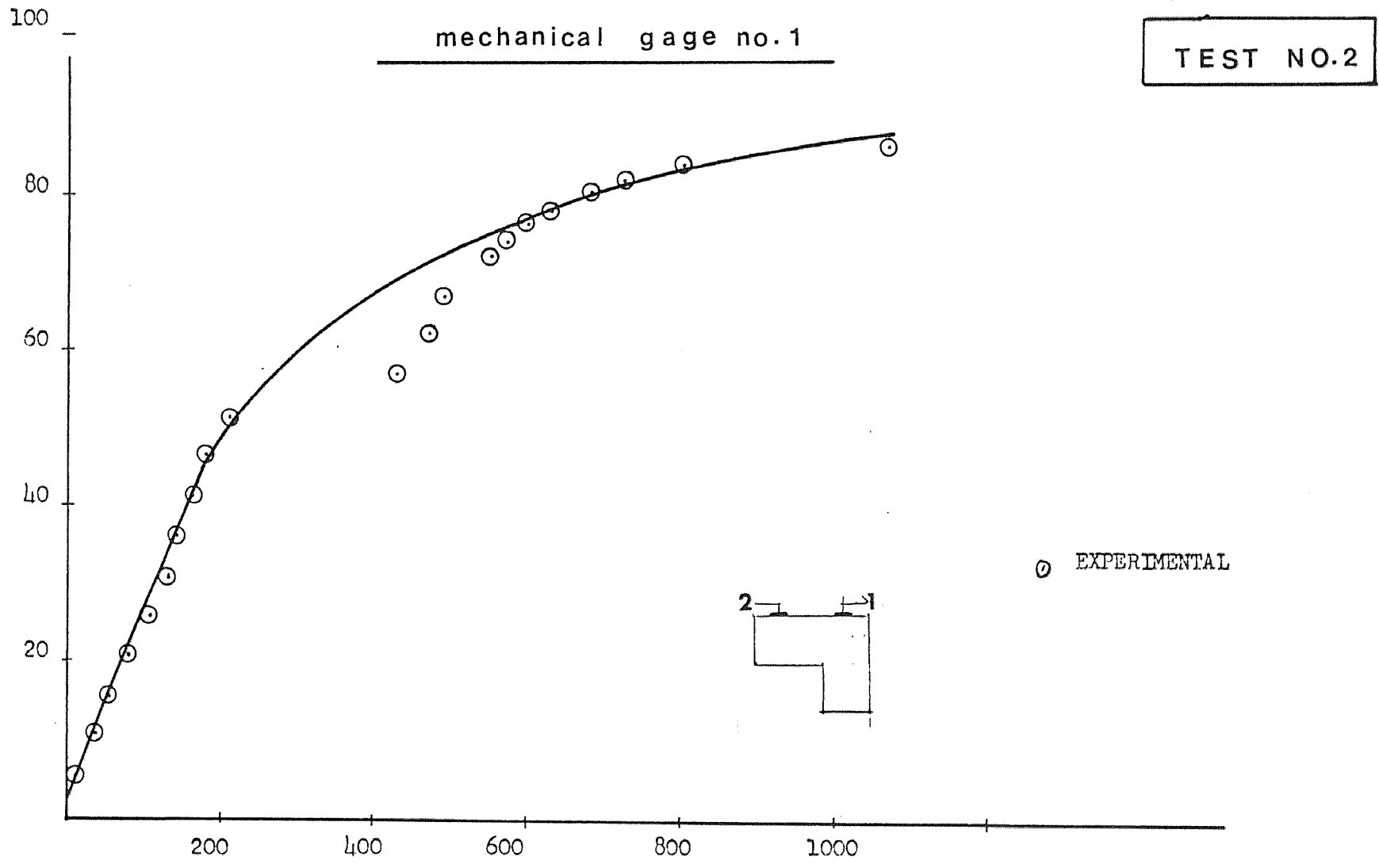

FIG.3 -3.aLOAD - DEFLECTION CURVE

TEST NO.2

mechanical gage no.1

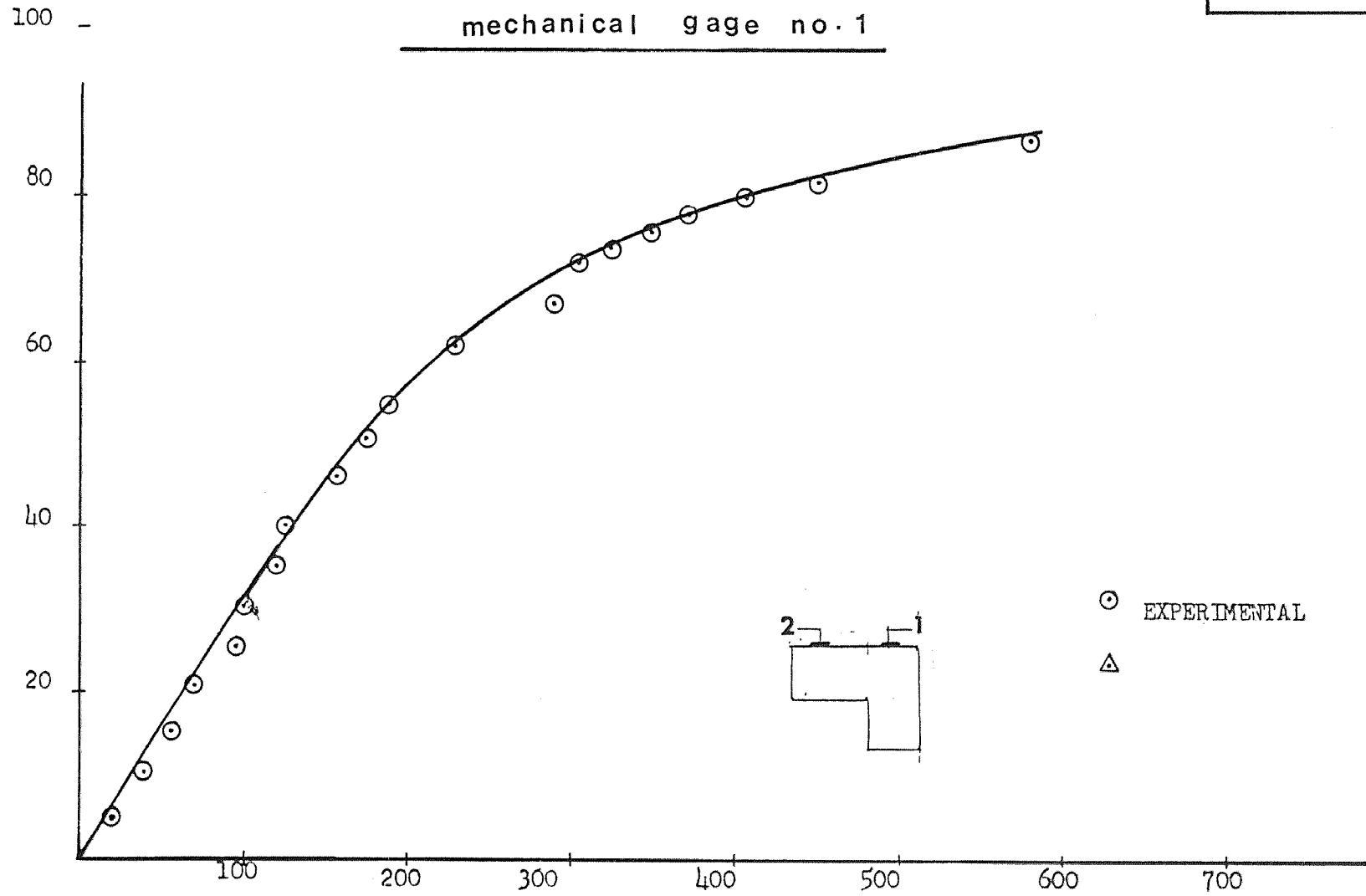

FIG. 3-4 LOAD-DELECTION CURVE

TEST NO.1

mechanical gage no.1

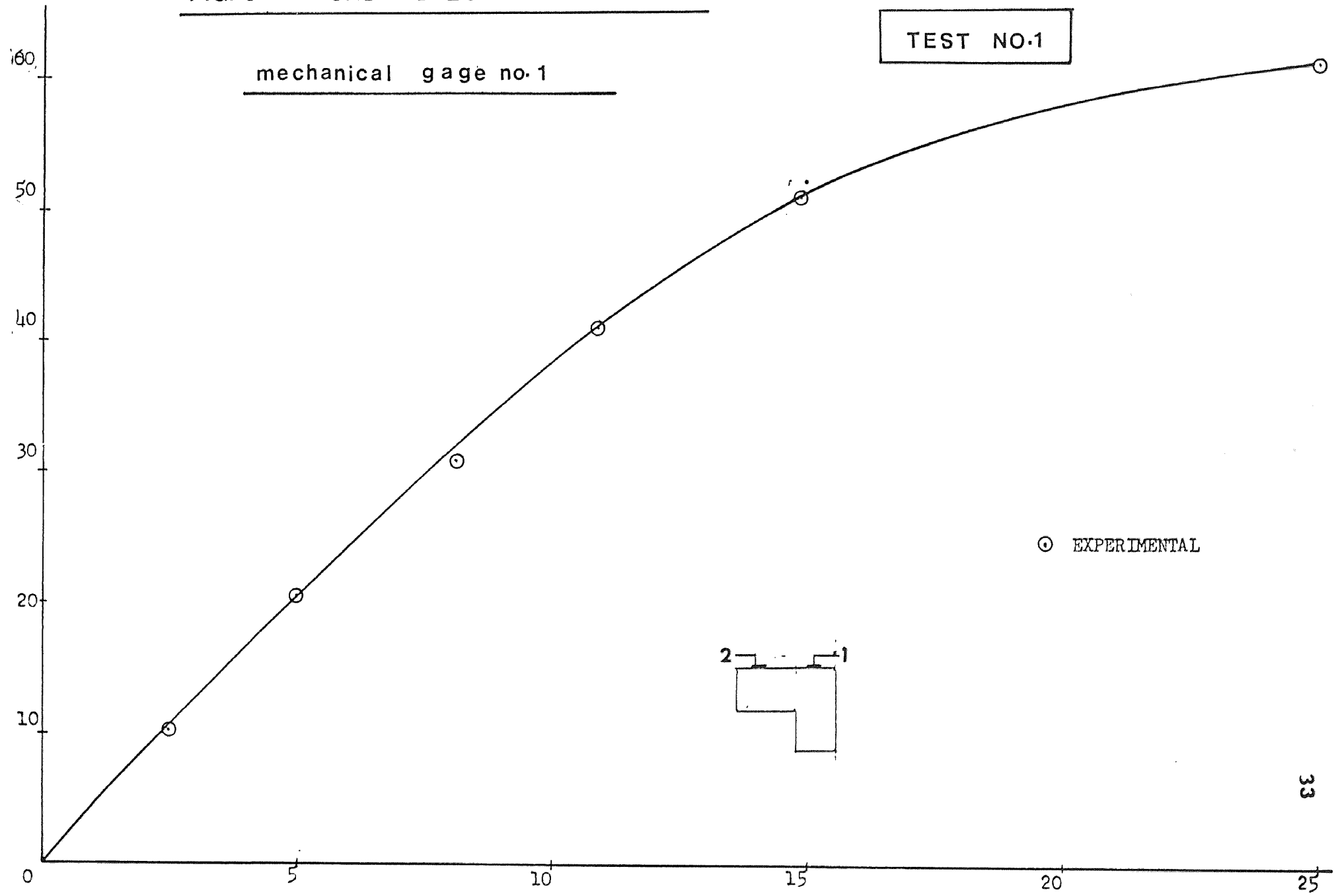
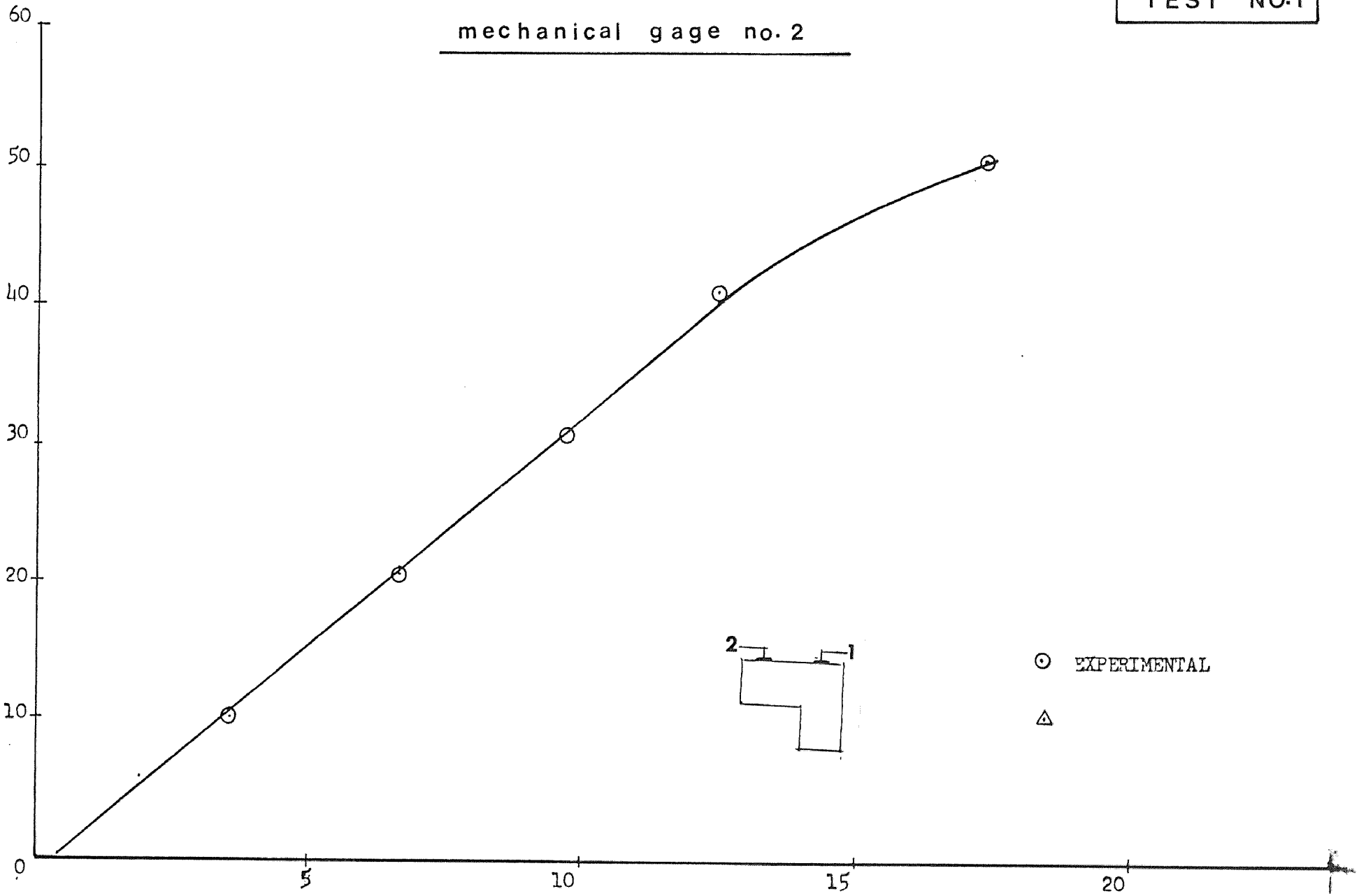

FIG.3-5 LOAD-DEFLECTION CURVE

TEST NO.1

mechanical gage no.2



3.3 Load-Strain Curves

The values of strains were measured at mid-span of the specimens at the farthest tension reinforcing bar and on the concrete surfaces at corners of the compression side, lead to determining whether the column specimen failed in tension or compression. Strain gages were installed on the surfaces of reinforcing bars and the concrete. Figures 3.6 through 3.26 show the experimental load-strain curves.

3.4 Biaxial Moment-Curvature Characteristics Under Combined Biaxial Bending and Axial Compression

3.4.1 Introduction

There have been no papers as yet published to study the experimental biaxial bending and axial compression. This section presents an experimental investigation by using an approach in which the moments and curvatures are established along the "x" and "y" axes ("x" and "y" passes through the center of the section). These Moment-curvature curves are to be compared with the results from computer program.

Two 1/4 scale reinforced concrete L-shaped columns were tested to establish the biaxial moment curvature relationship with the pin-ended conditions. (Figure 2.15).

3.4.2 Analysis of Test Results

Two common methods, namely "Strain Gage Methods" and "Demec Gage Method" have been used to obtain the strain distribution along "x" and "y" axes.

The typical strain gage arrangements for the measurement of strain values along "x" and "y" are shown in Figure 3.27 and 3.28. Also Figure 3.29 and 3.30 show the arrangement of Demec Gages for tests No. 4 and No. 5 to obtain the strain distributions along the axes for which the average

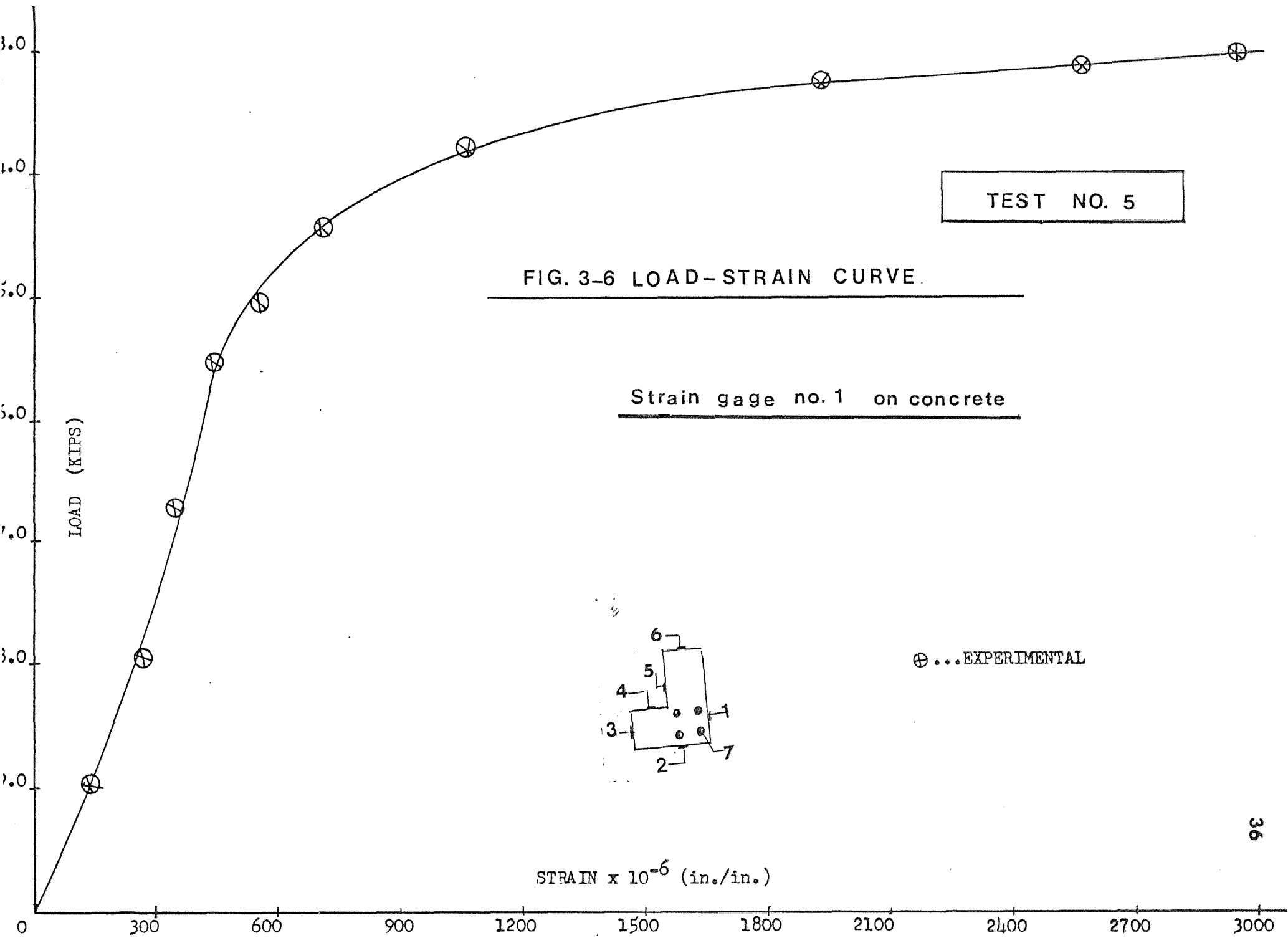

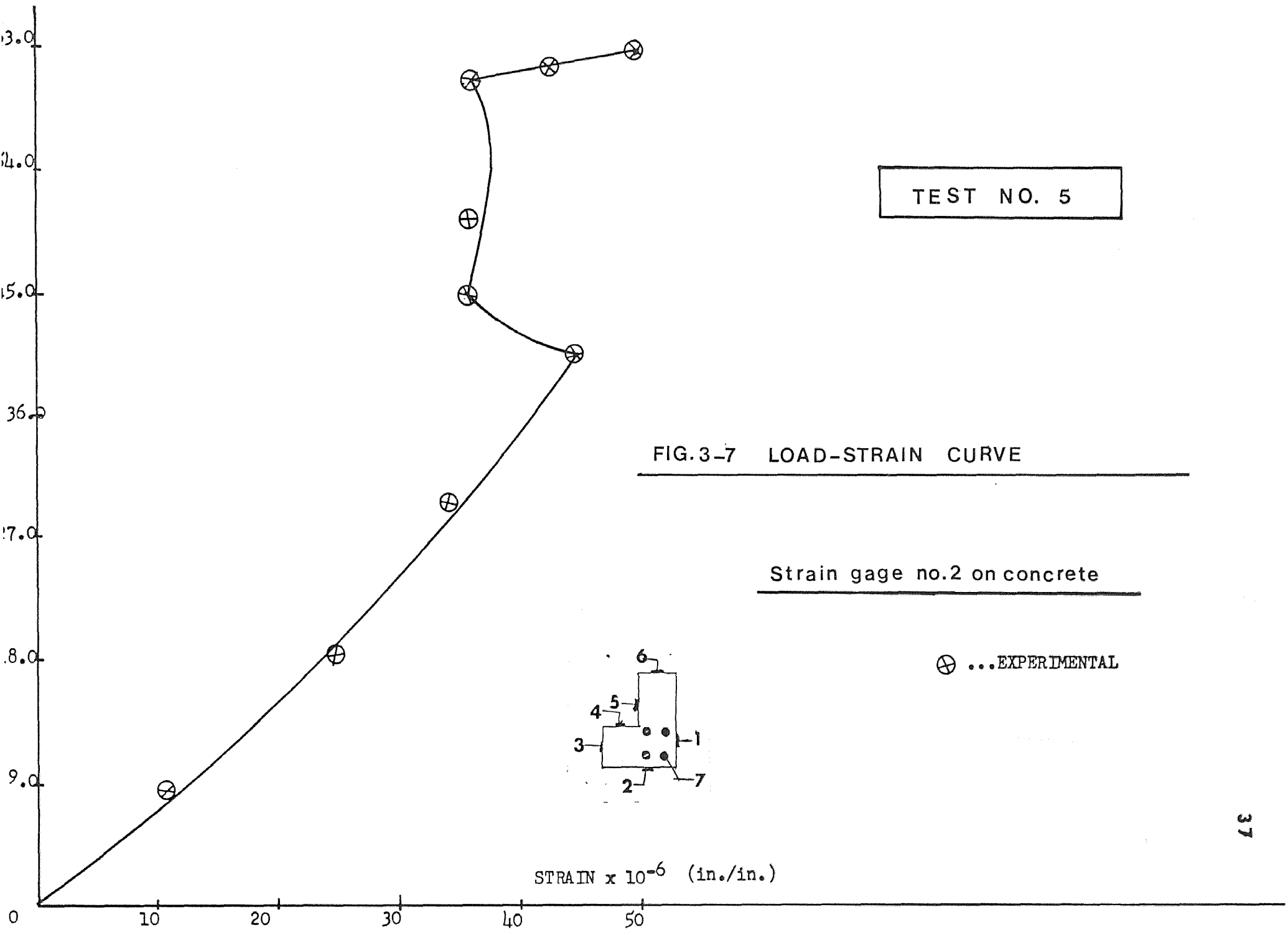

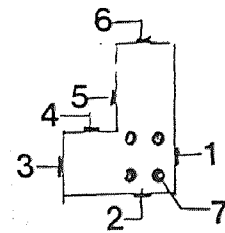
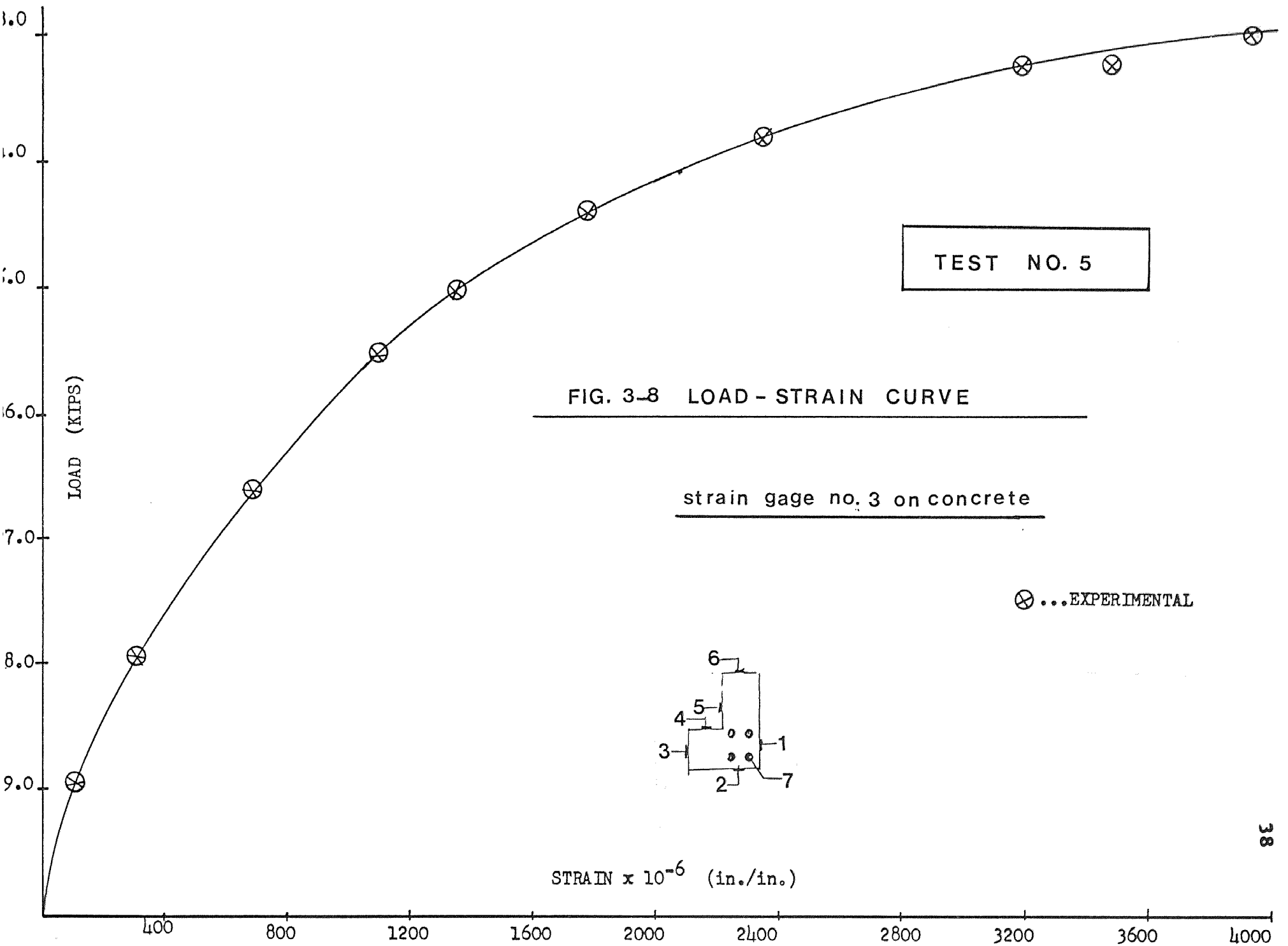

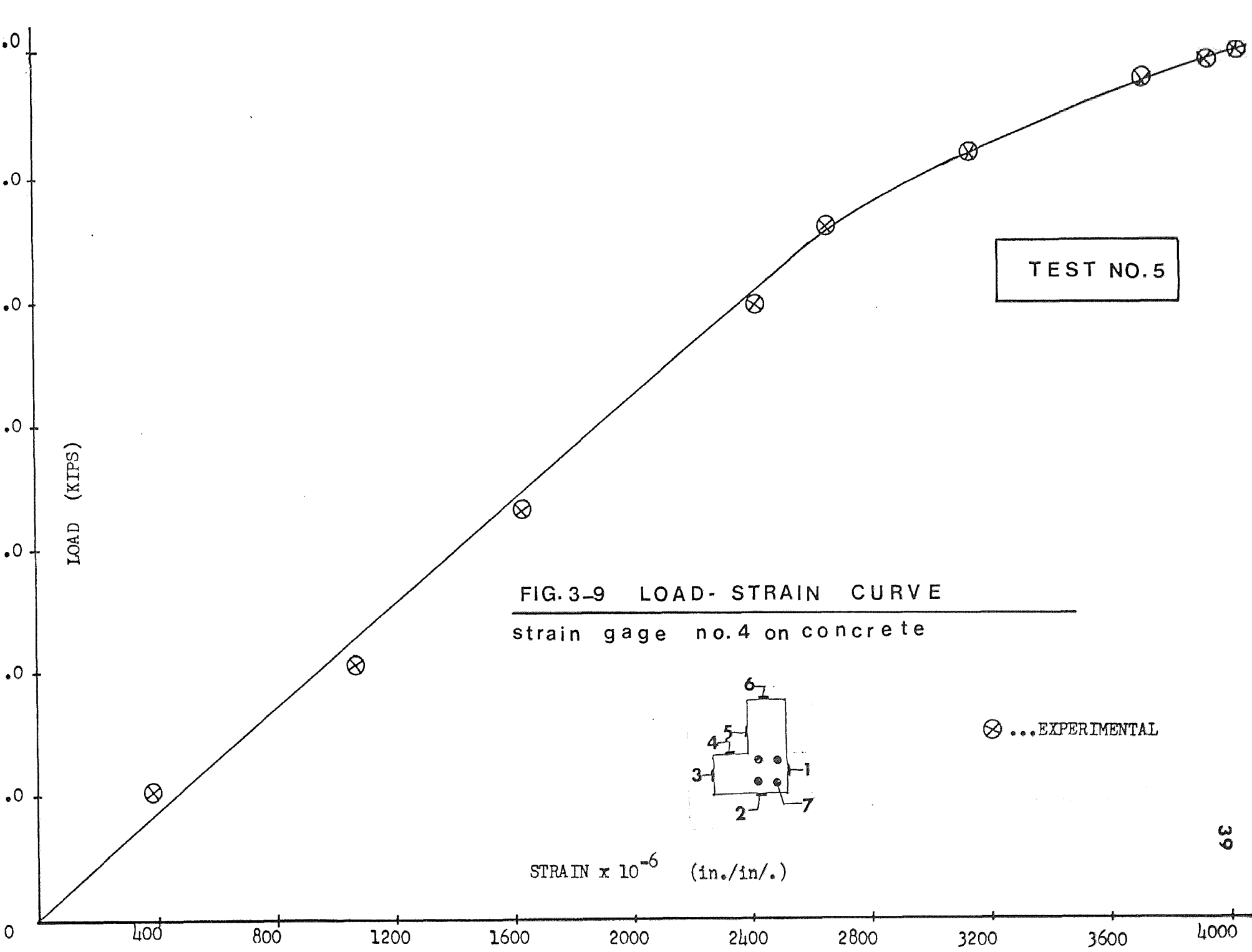

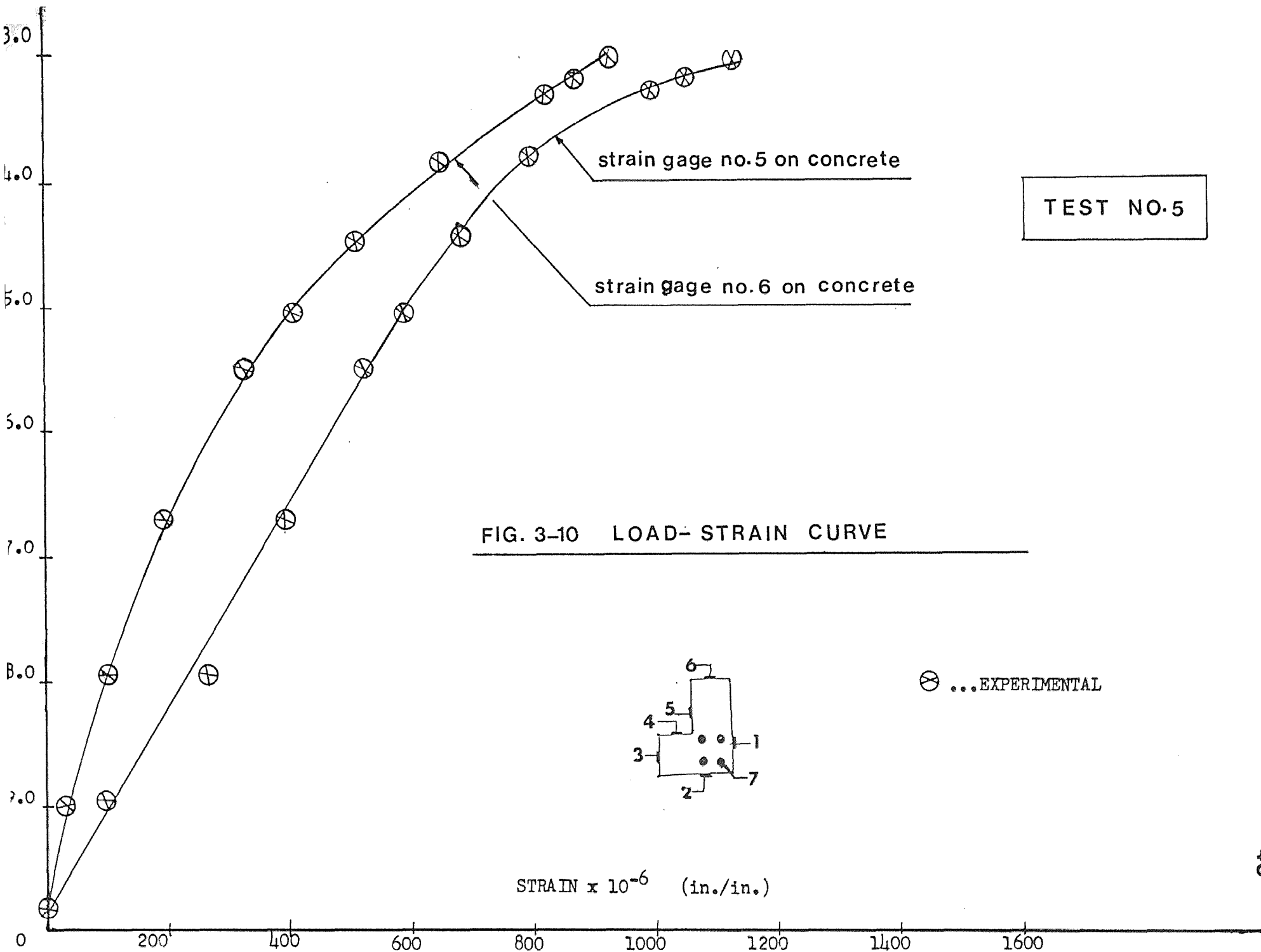

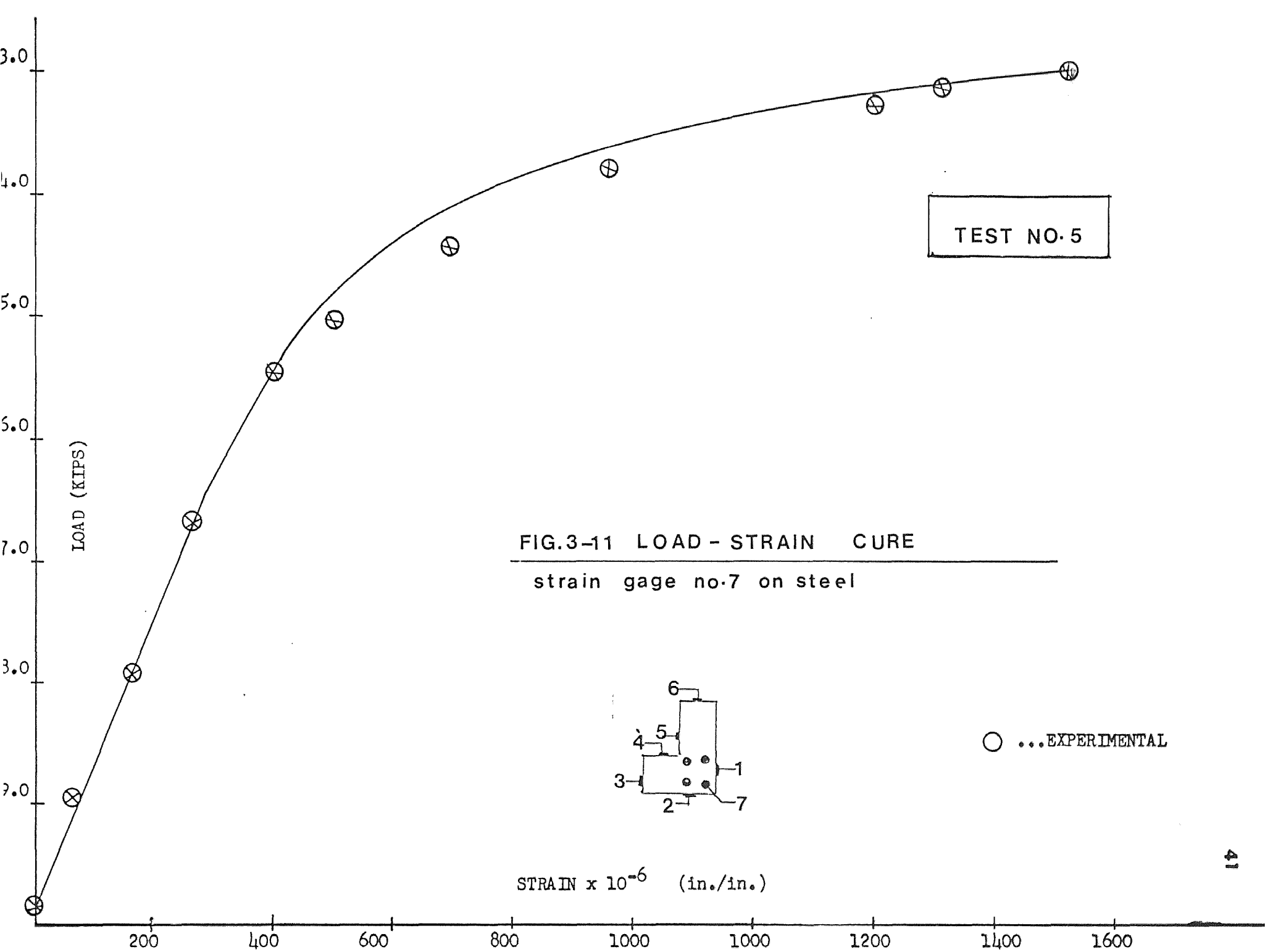

FIG. 3-12 LOAD-STRAIN CURVE

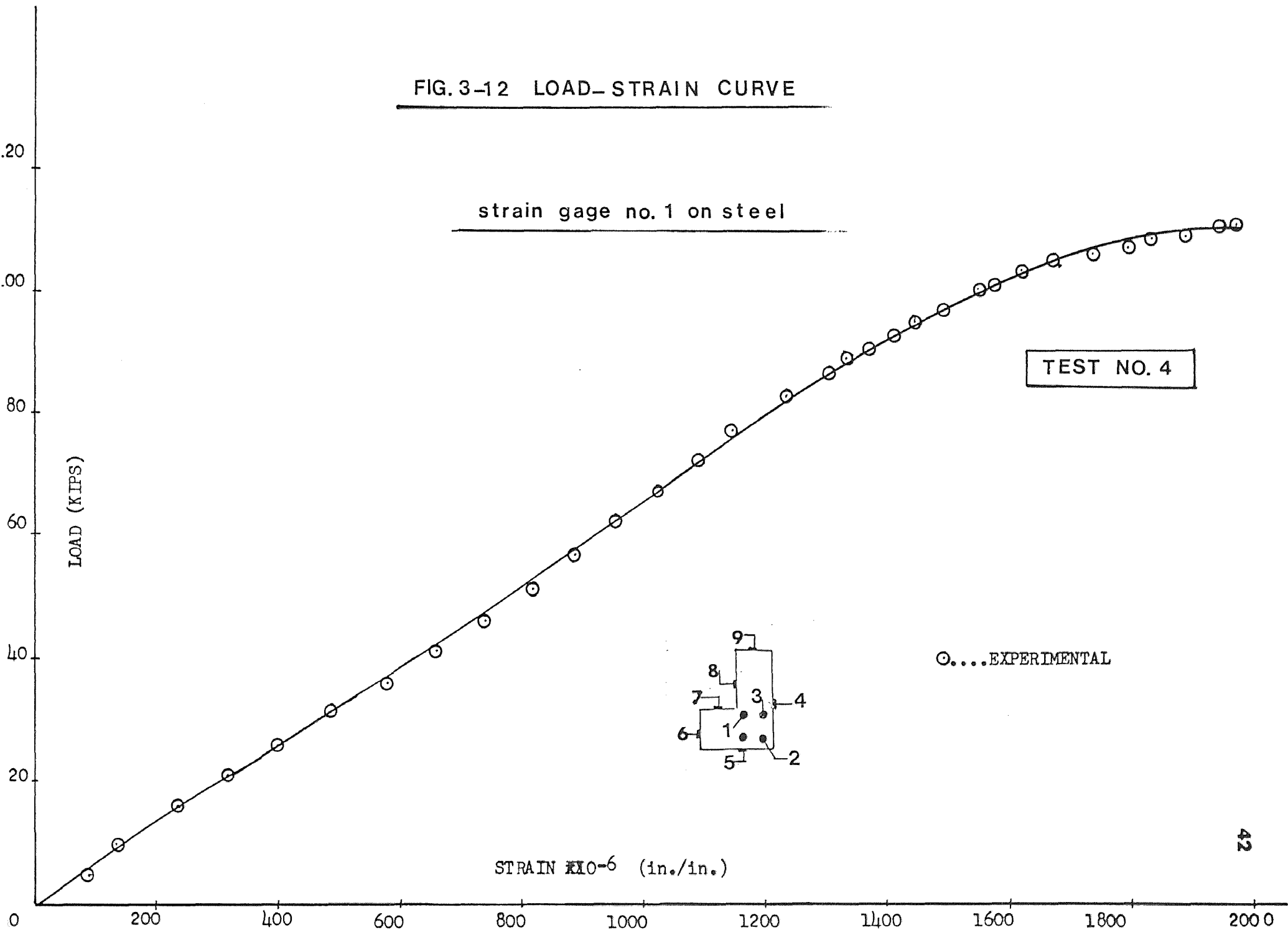

FIG.3-13 LOAD- STRAIN CURVE

strain gage no.2 on steel

TEST NO. 4

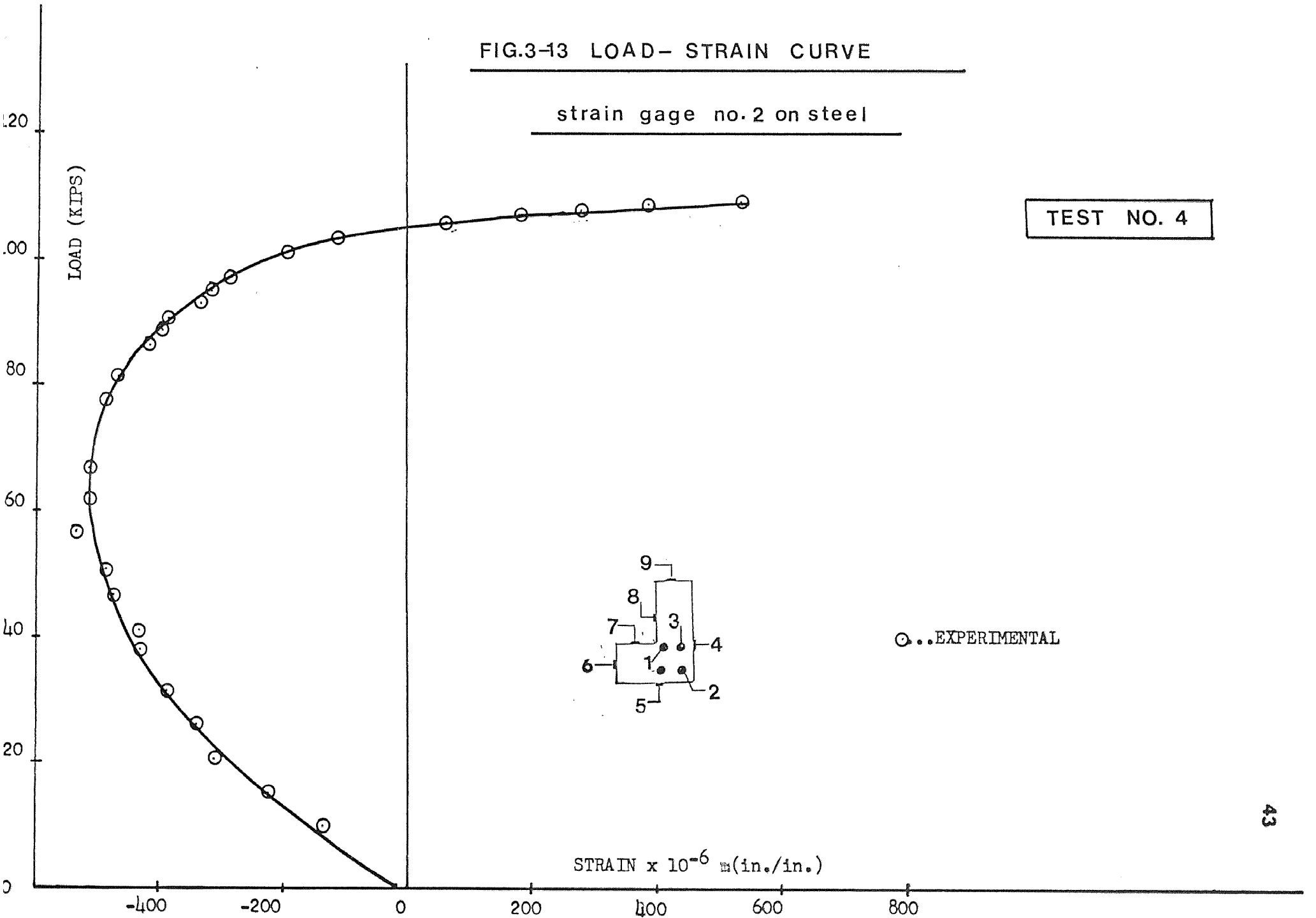

FIG. 3-14 LOAD - STRAIN . CURVE

strain gage no. 3 on steel

TEST NO. 4

LOAD (KIPS)

○...EXPERIMENTAL

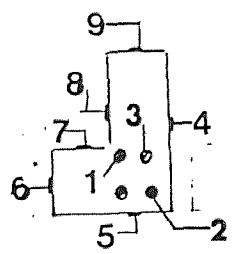

STRAIN $\times 10^{-6}$ (in./in/)

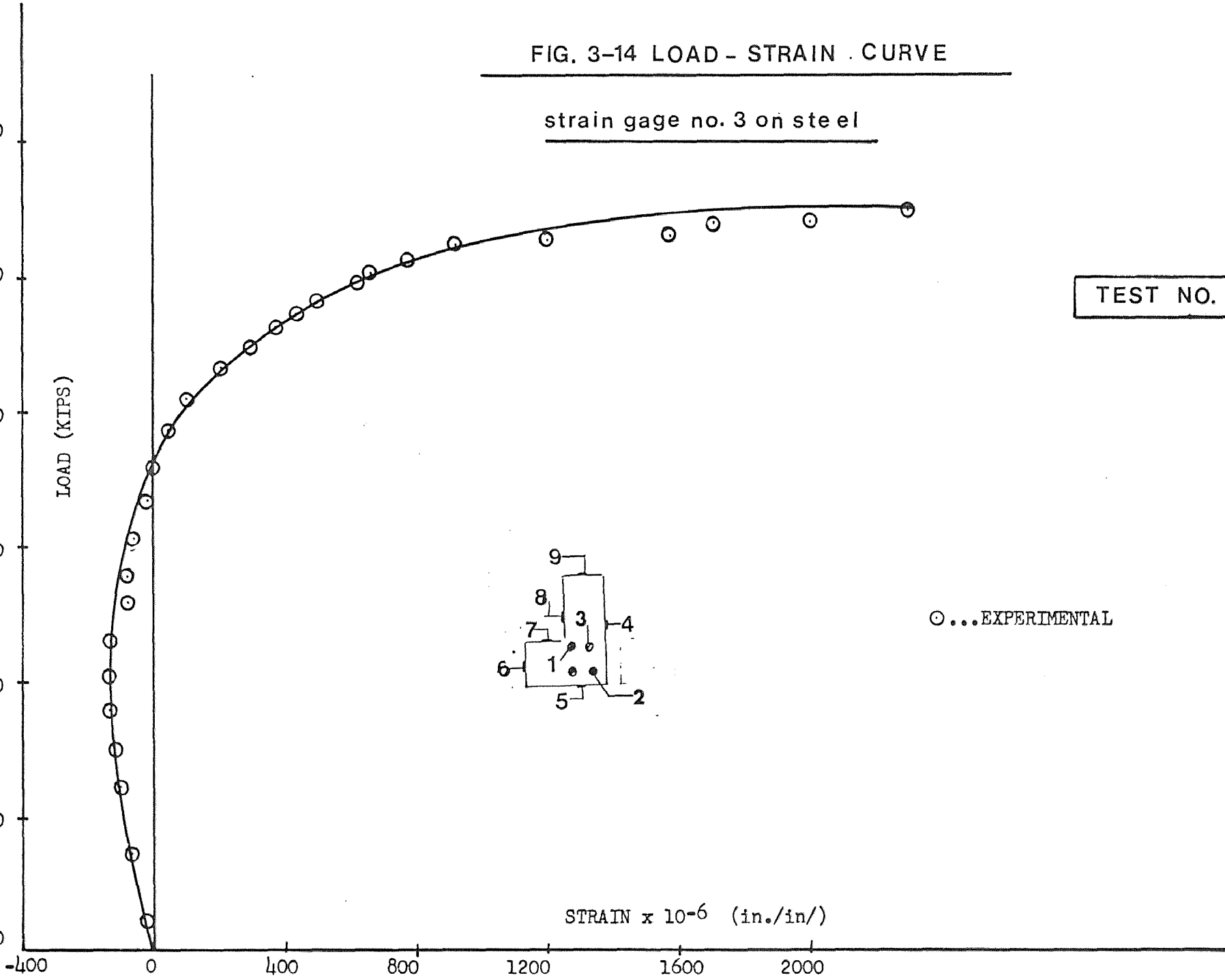

FIG.3-15 LOAD-STRAIN CURVE

strain gage no. 4 on concrete

TEST NO. 4

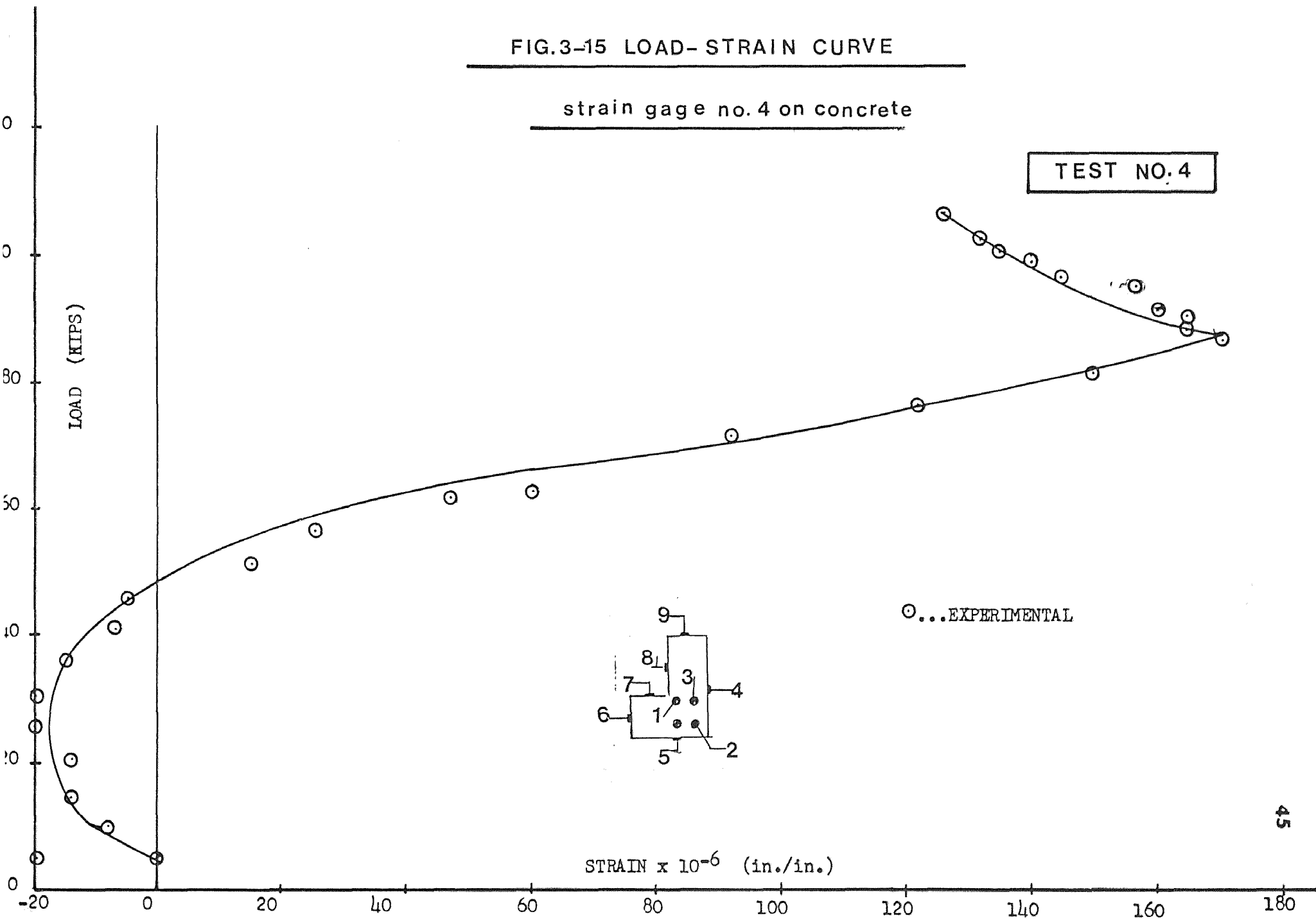

FIG. 3-16 LOAD-STRAIN CURVE

strain gage no.5 on concrete

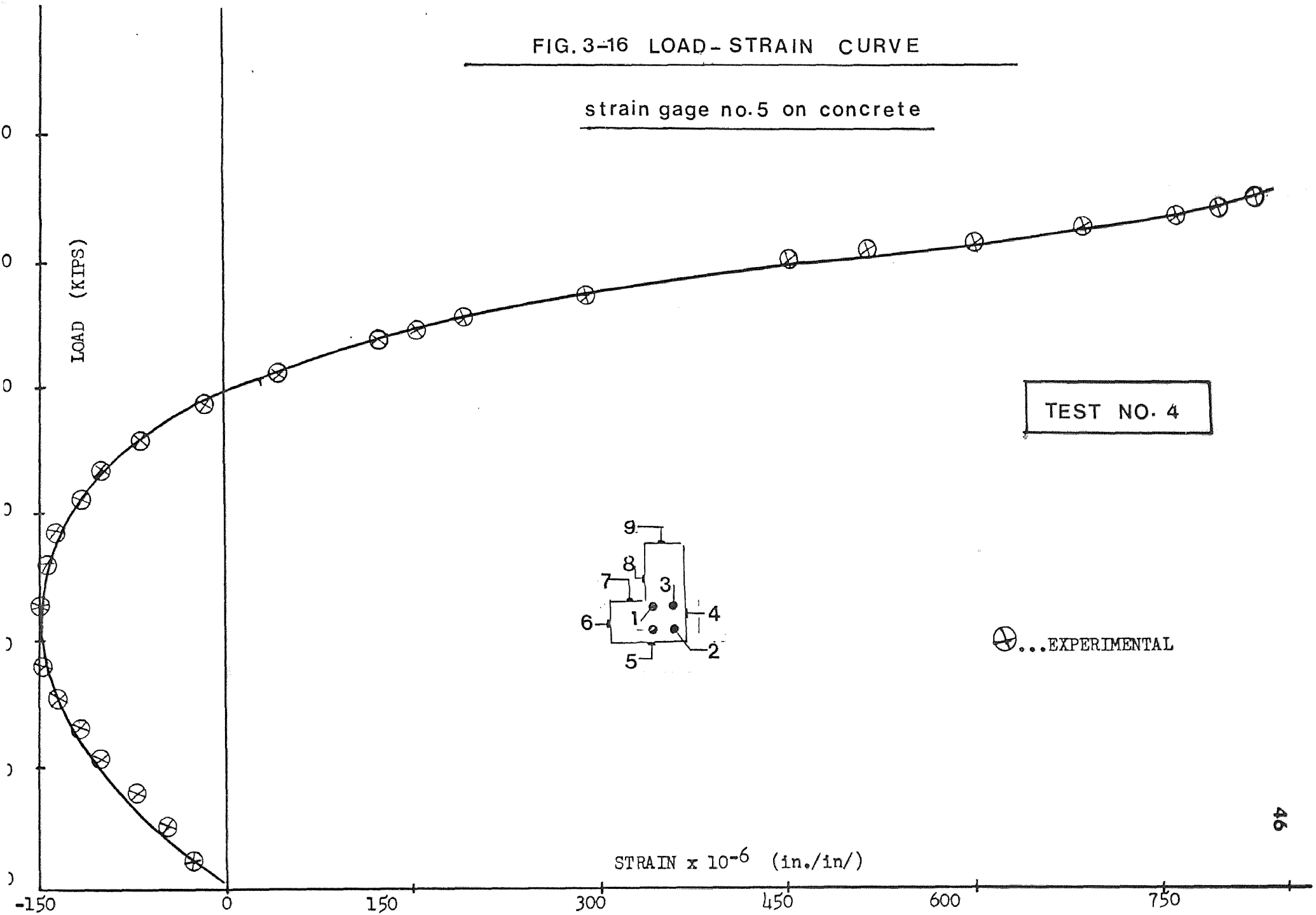

FIG.3-17 LOAD - STRAIN CURVE

strain gage no.6 on concrete

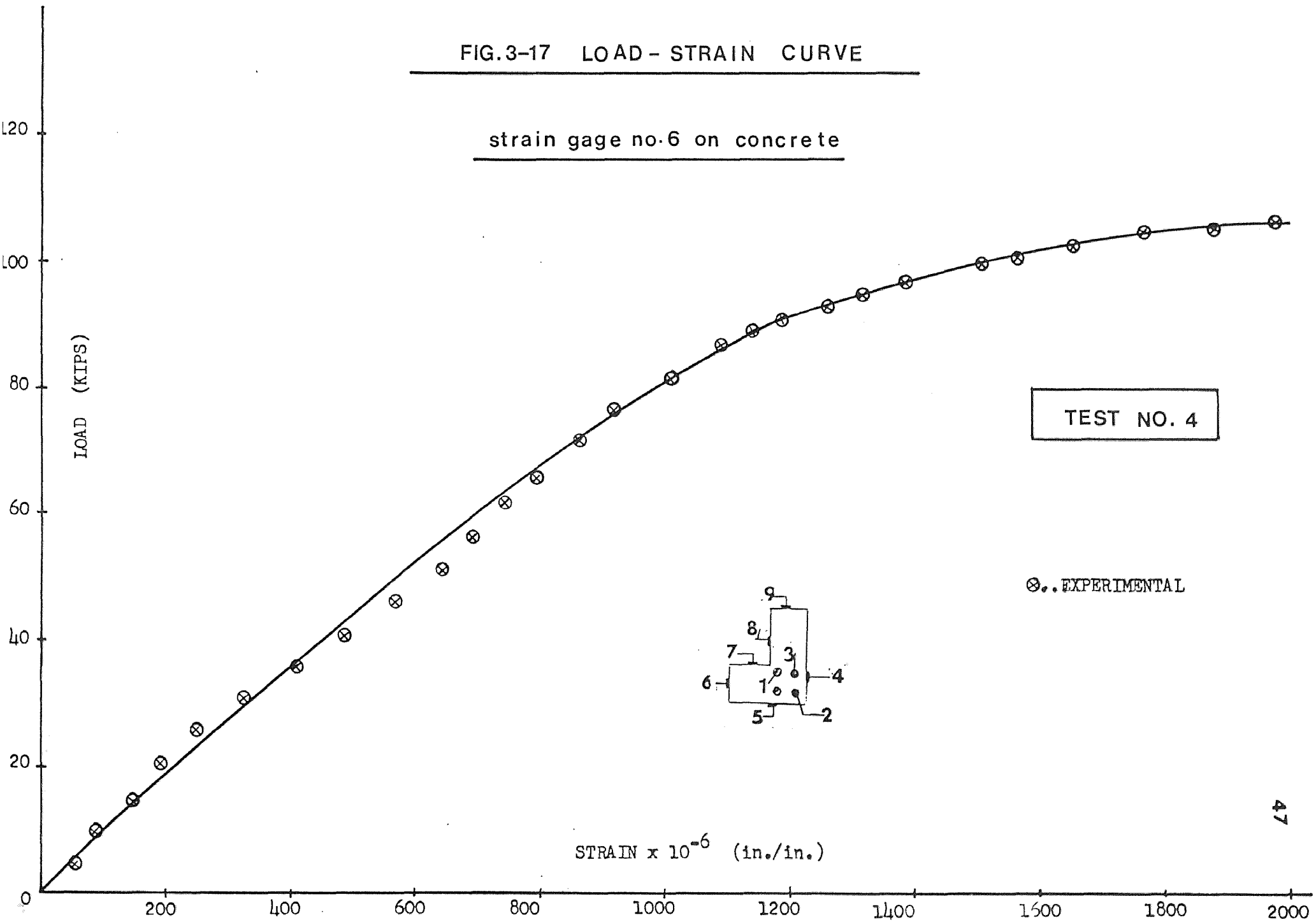

FIG. 3-18 LOAD - STRAIN CURVE

strain gage no. 7 on concrete

LOAD (KIPS)

TEST NO. 4

⊗ ... EXPERIMENTAL

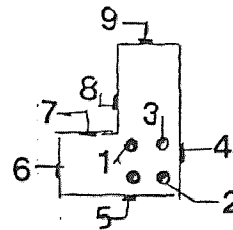

STRAIN $\times 10^{-6}$ (in./in.)

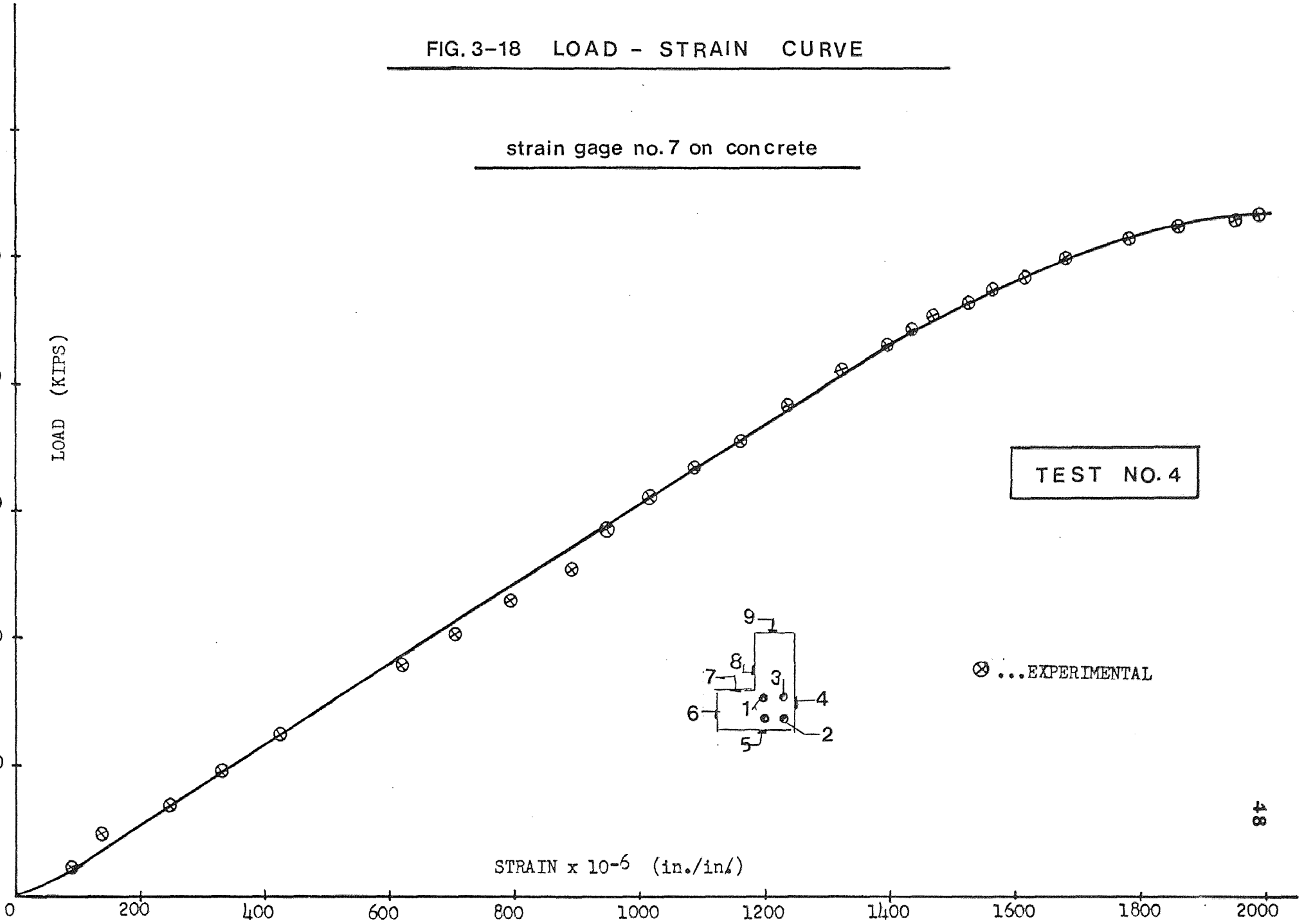

FIG. 3-19 LOAD - STRAIN CURVE

strain gage no.8 on concrete

TEST NO 4

LOAD (KIPS)

⊗ ... EXPERIMENTAL

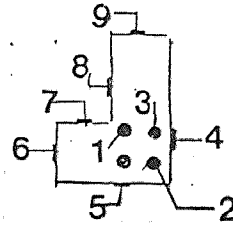

STRAIN $\times 10^{-6}$ (in./in.)

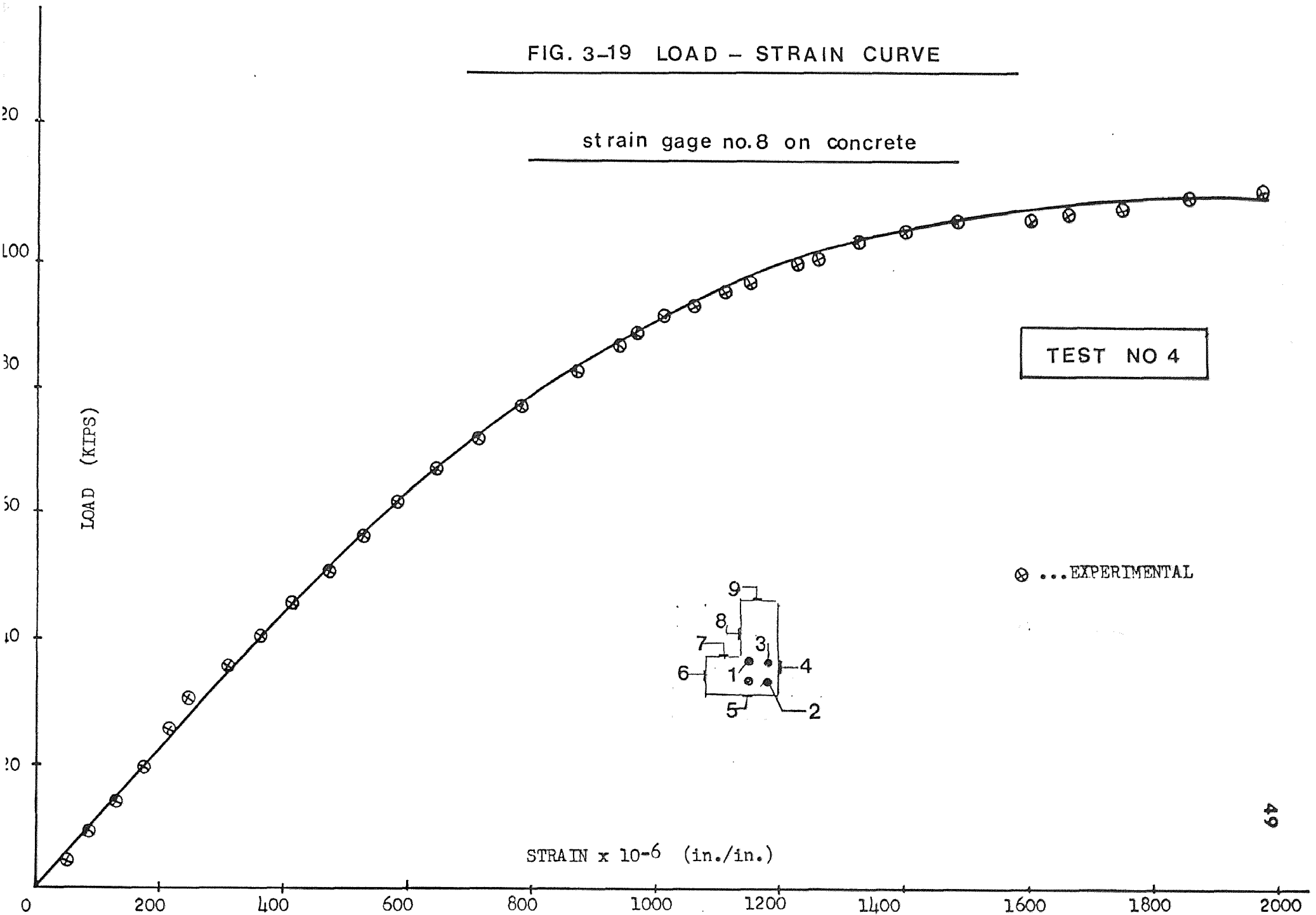
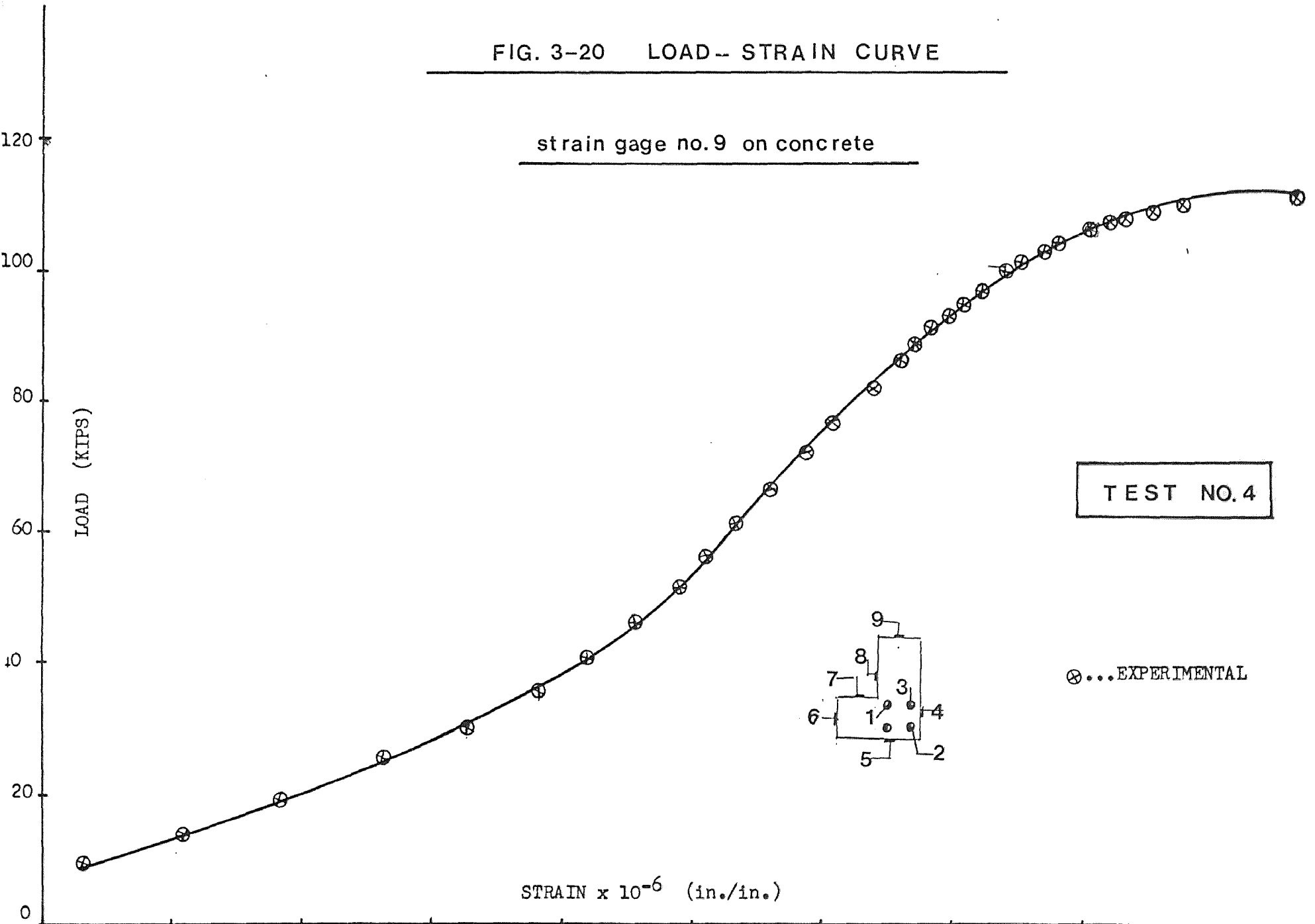

FIG. 3-20 LOAD- STRAIN CURVE

strain gage no.9 on concrete



TEST NO. 4

X... EXPERIMENTAL

FIG.3-21 LOAD - STRAIN CURVE

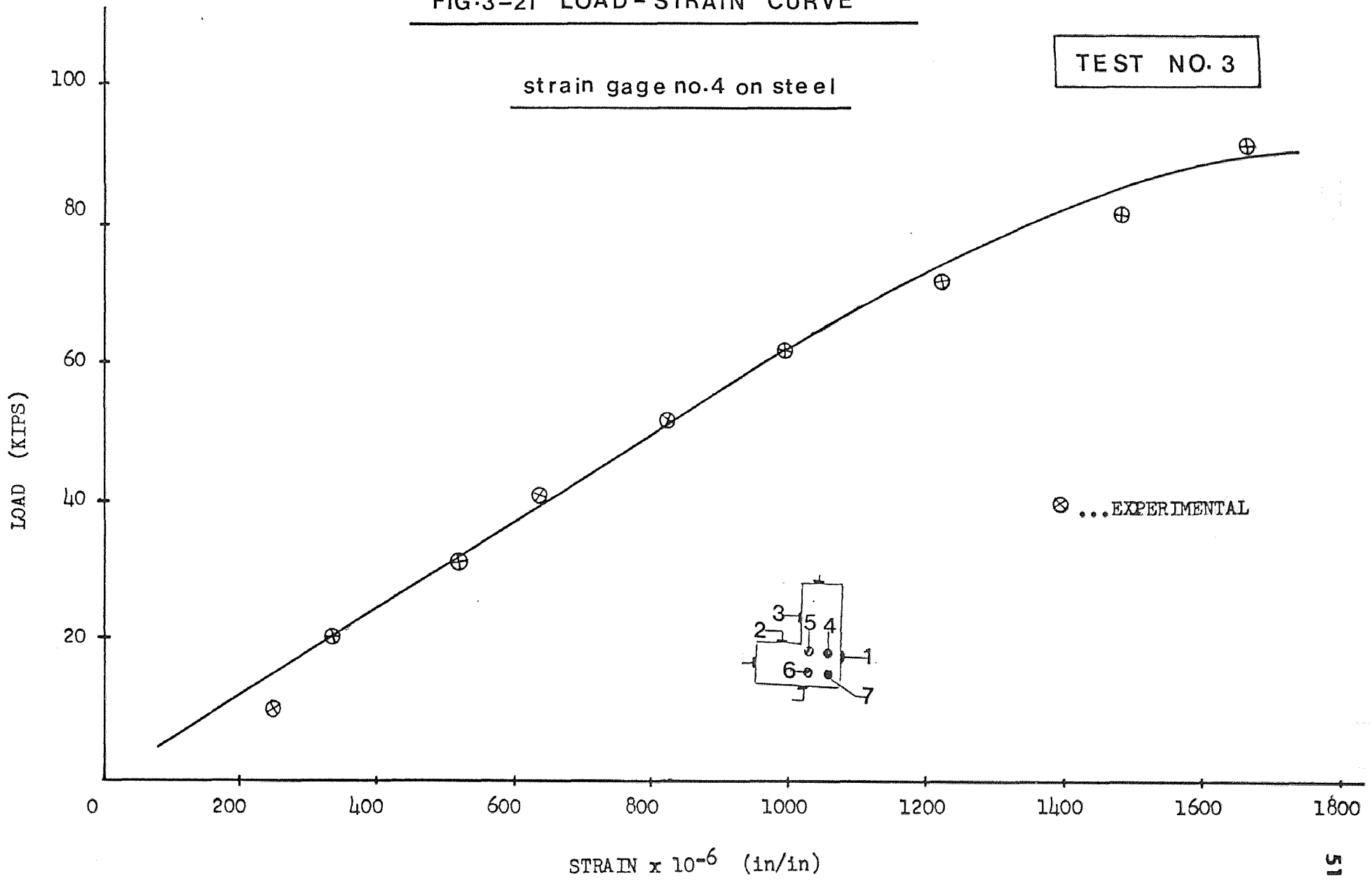

FIG. 3-22 LOAD - STRAIN CURVE

gage no. 5 on steel

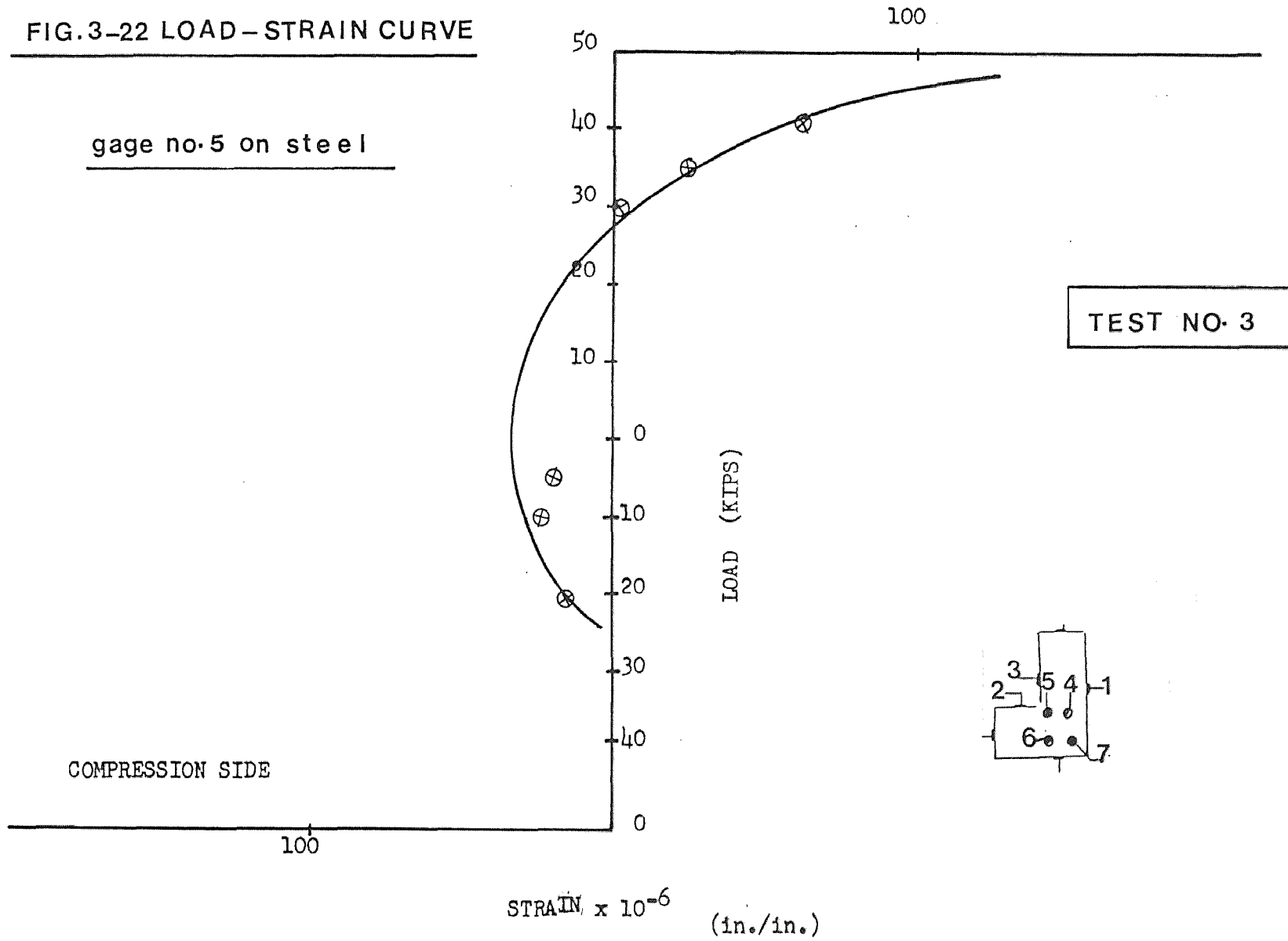

FIG. 3-23 LOAD-STRAIN CURVE

strain gage no.1 on concrete

TEST NO. 3

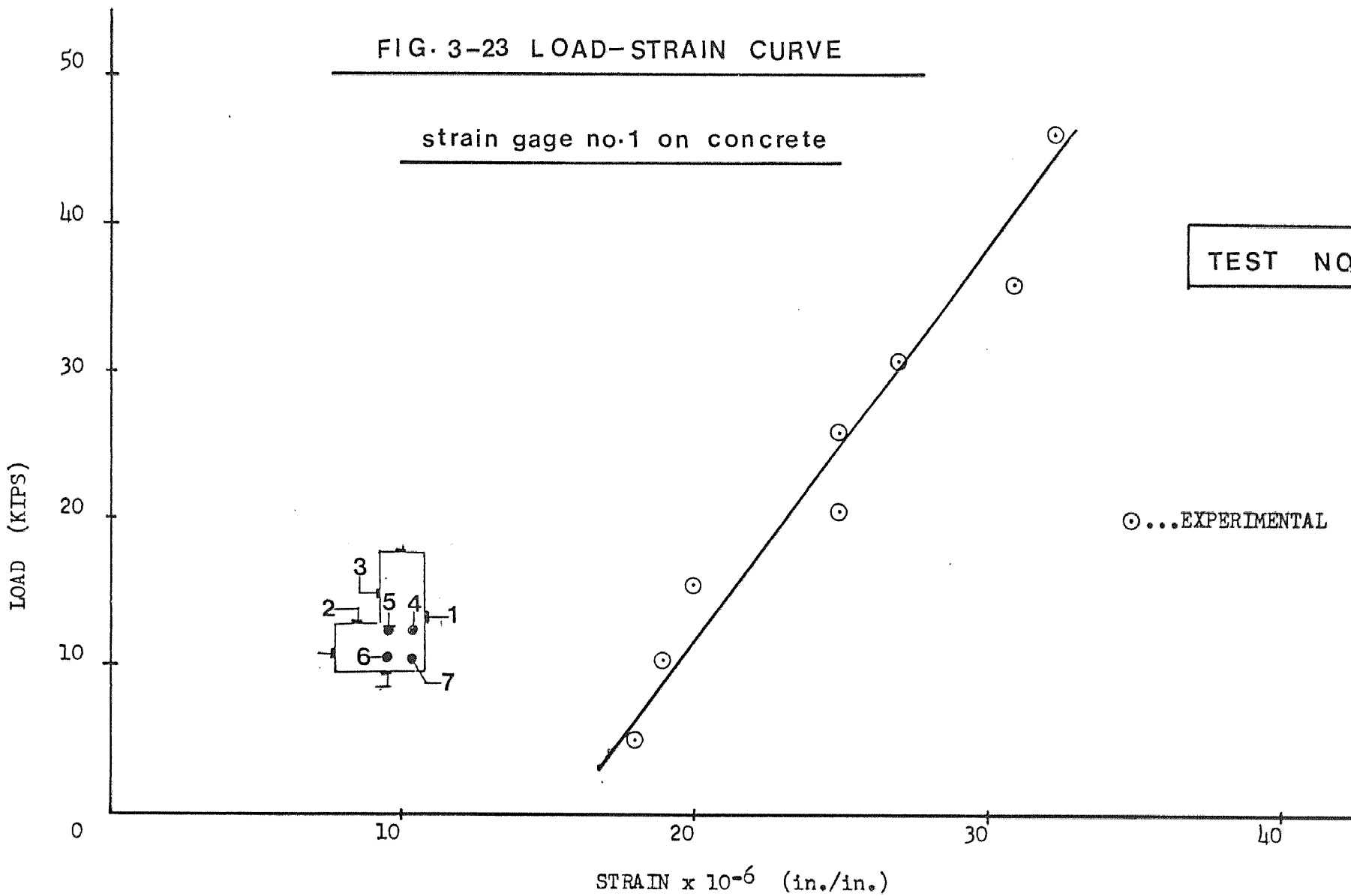

FIG. 3-24 LOAD - STRAIN CURVE

strain gage no. 2 on concrete

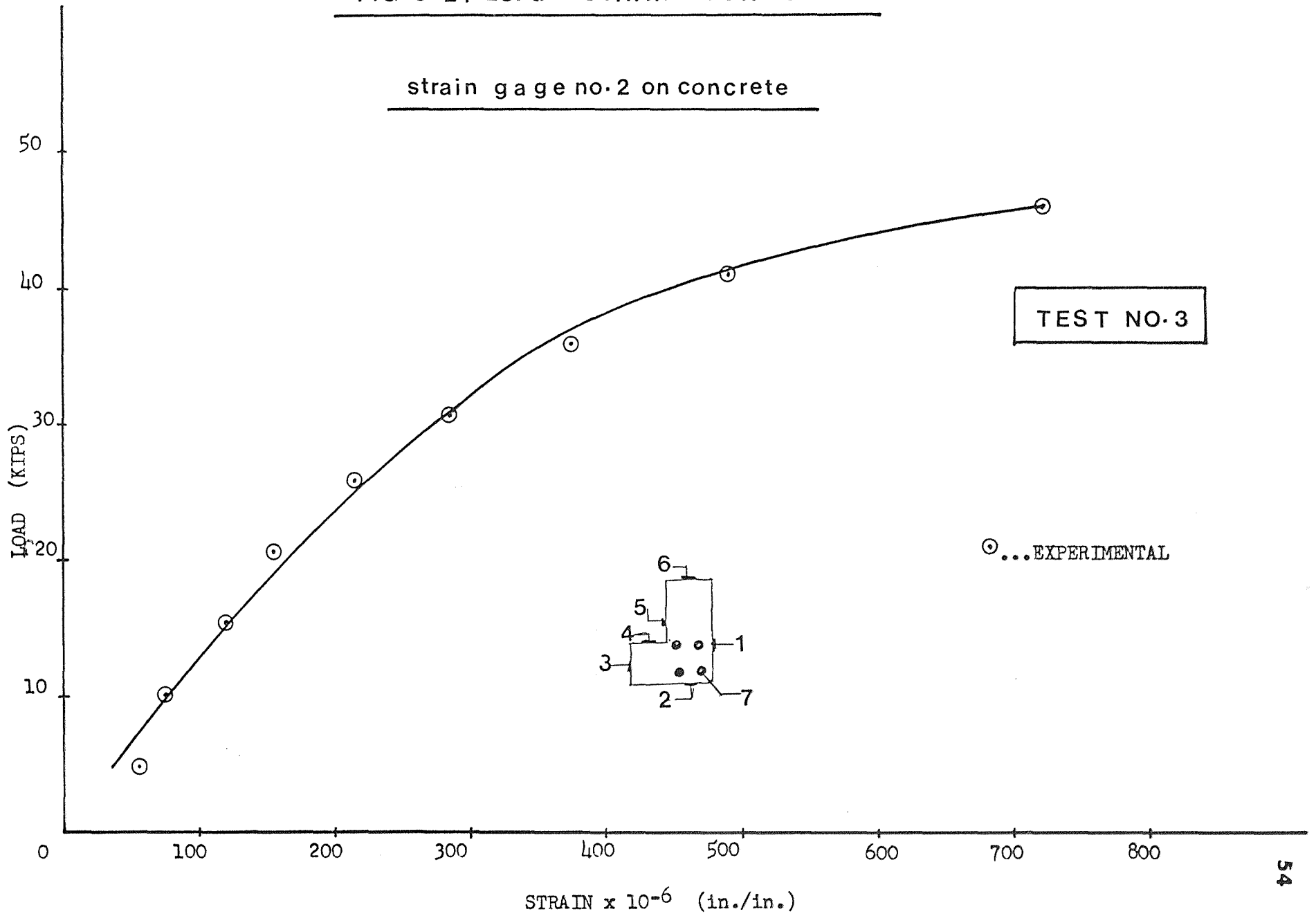

FIG. 3-25 LOAD-STRAIN CURVE

strain gage no.6 on steel

TEST NO. 3

LOAD (KIPS)

⊙ ...EXPERIMENTAL

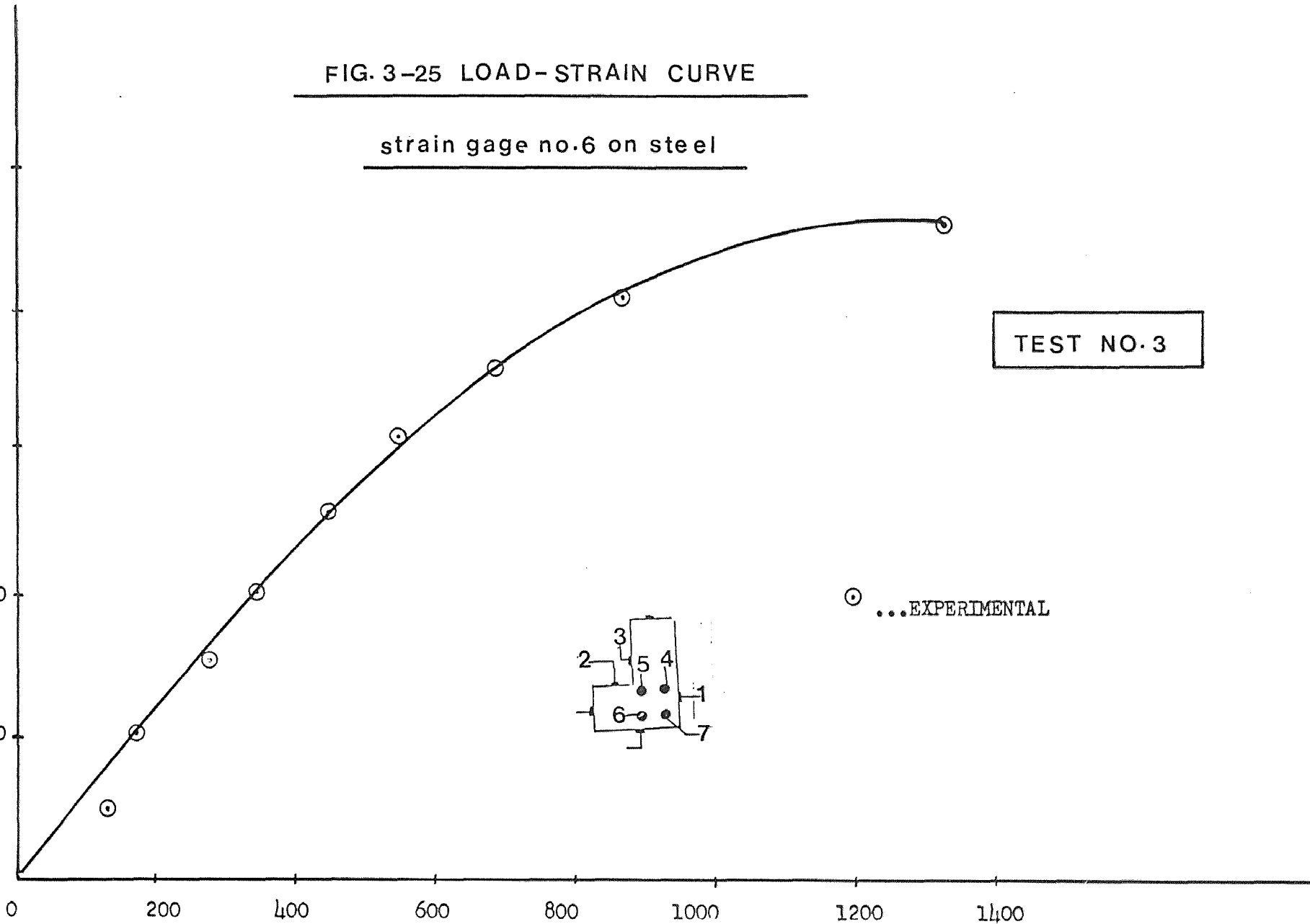
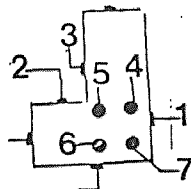

STRAIN x 10⁻⁶ (in./in.)

FIG.3-26 LOAD-STRAIN CURVE

strain gage no.7 on steel

TEST NO.3

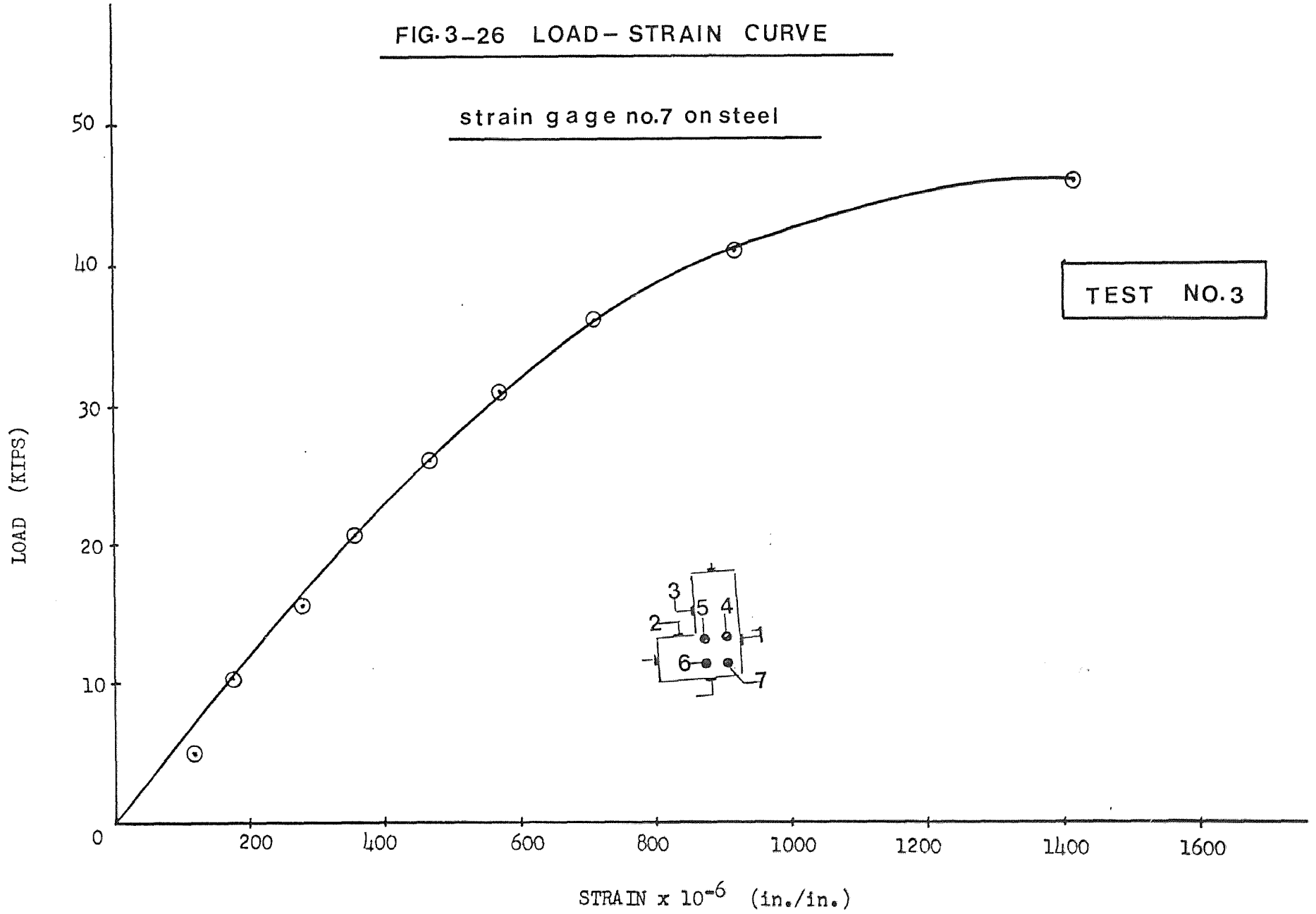

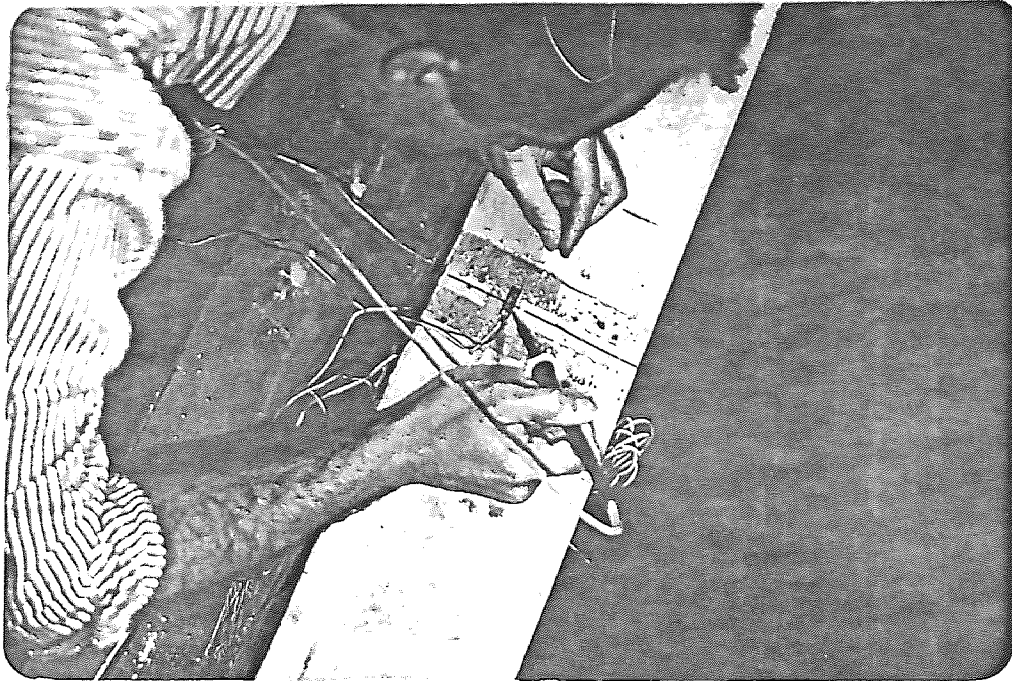

Figure 3.27 - Arrangement of Demec Gages for Specimen No. 4 and No. 5.

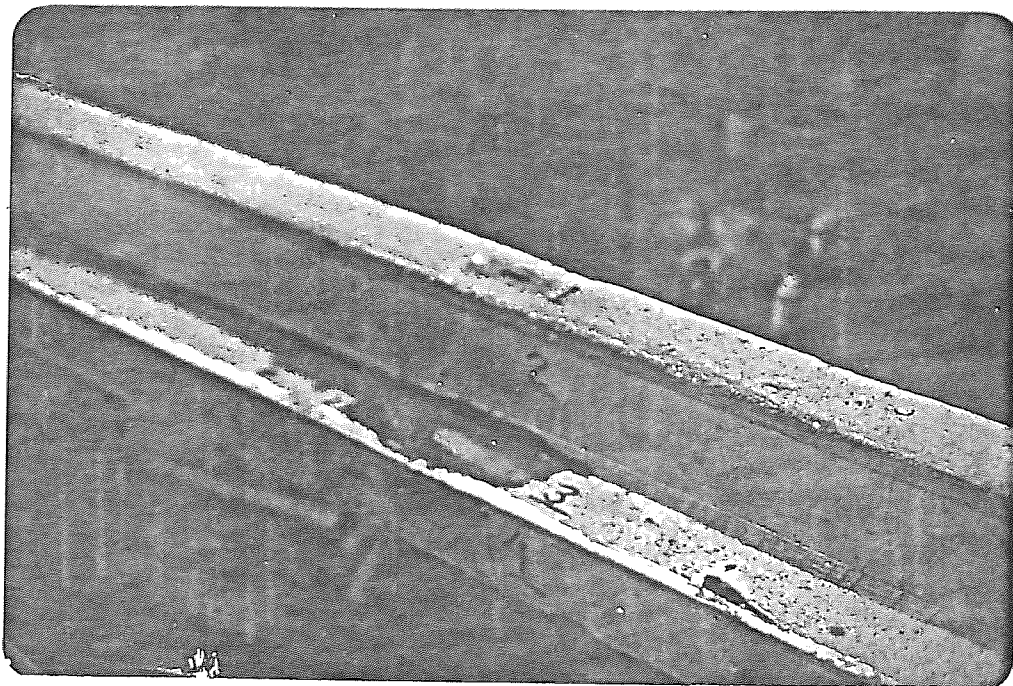

Figure 3.28 - Arrangement of Demec Gages for Specimen No. 4 and No. 5.

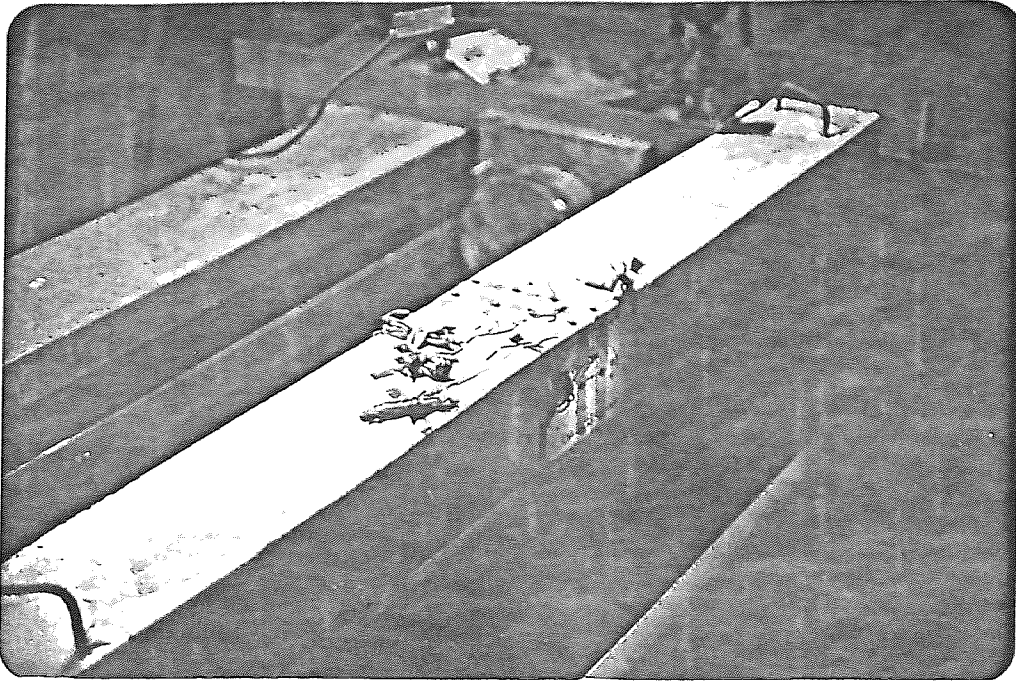

Figure 3.29 - Arrangement of Strain Gages for Specimen No. 4 and No. 5.

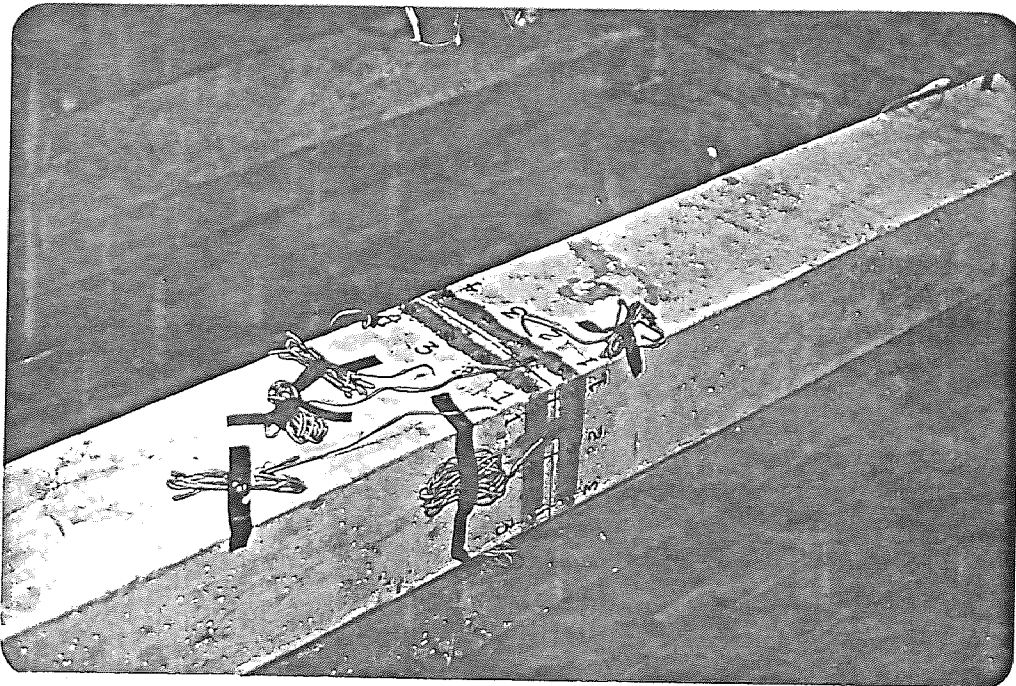

Figure 3.30 - Arrangement of Strain Gages for Specimen No. 4 and No. 5.

curvature along the axes is required. Generally, the average values from both sides of Demec gage measurements along "x" and "y" axes were determined to evaluate the strain distributions along "x" and "y" axes which pass through the centroid of the column sections. The strain distribution curves are shown in Figure 3.31 and 3.32. Also, the Demec Gages method was used for biaxially loaded column in tests No. 4 and No. 5. If the strain distributions across the section are linear or near linear, the curvatures " ϕ_x " and " ϕ_y " are given by

$$\phi_x \text{ or } \phi_y = \frac{e_c + e_s}{d}$$

Where "d" is distance between the points where strains are " e_s " and " e_c ".

If the strain distributions are non-linear, then the curvatures " ϕ_x " and " ϕ_y " are given by (5).

$$\phi_x \text{ or } \phi_y = \frac{e_c}{Kd}$$

Where Kd is distance between E_c and the position of zero strain point in "x" or "y" axis.

Figure 3.33 through 3.35 show the experimental biaxial moment curvature curves.

3.5 Crack Patterns and Failure Modes for Biaxially Loaded Columns

In general, there are three failure modes which can be observed in test on columns subjected to axial compression:

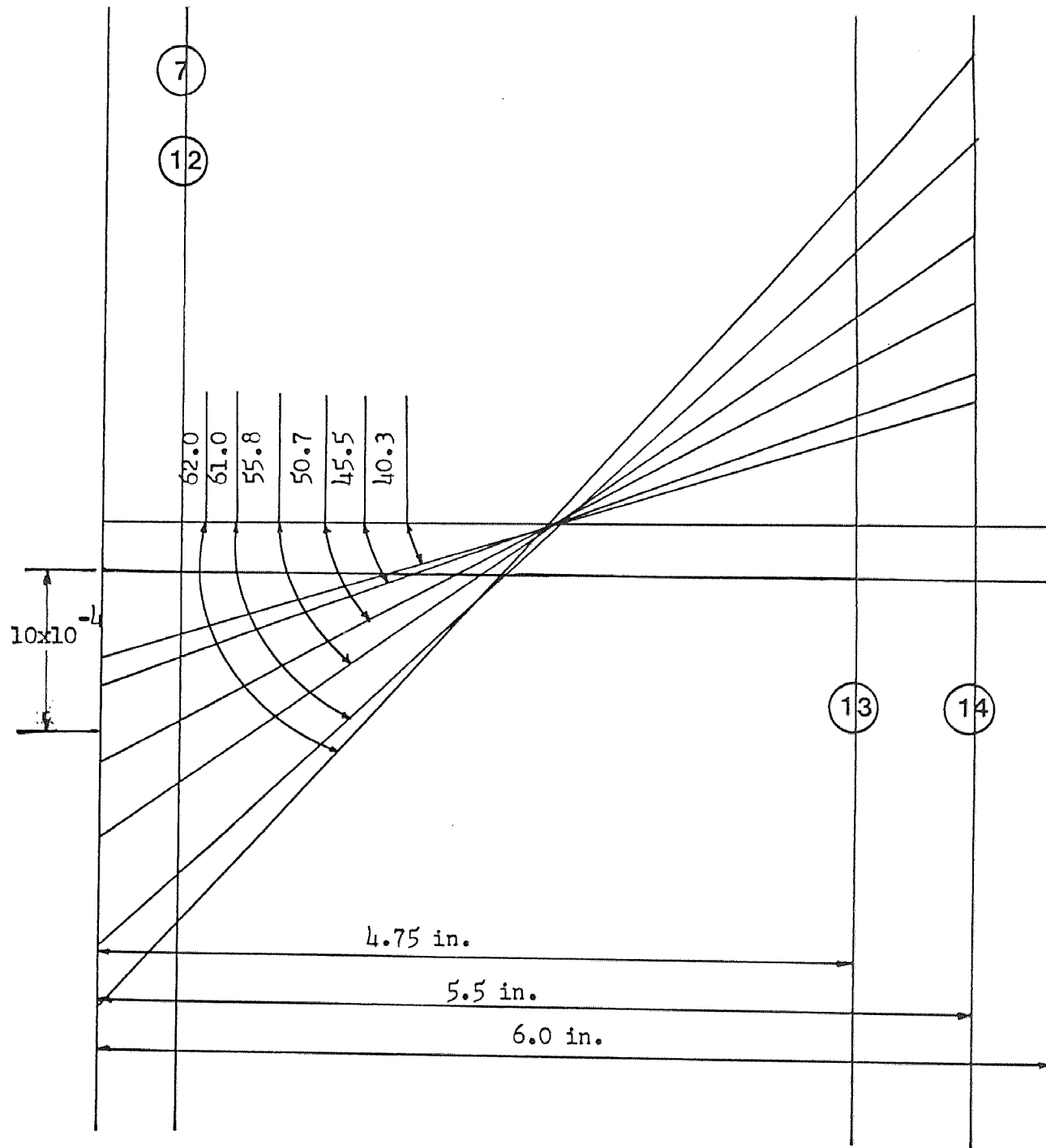

TEST NO. 5

FIG. 3-31
CURVATURES 'X'

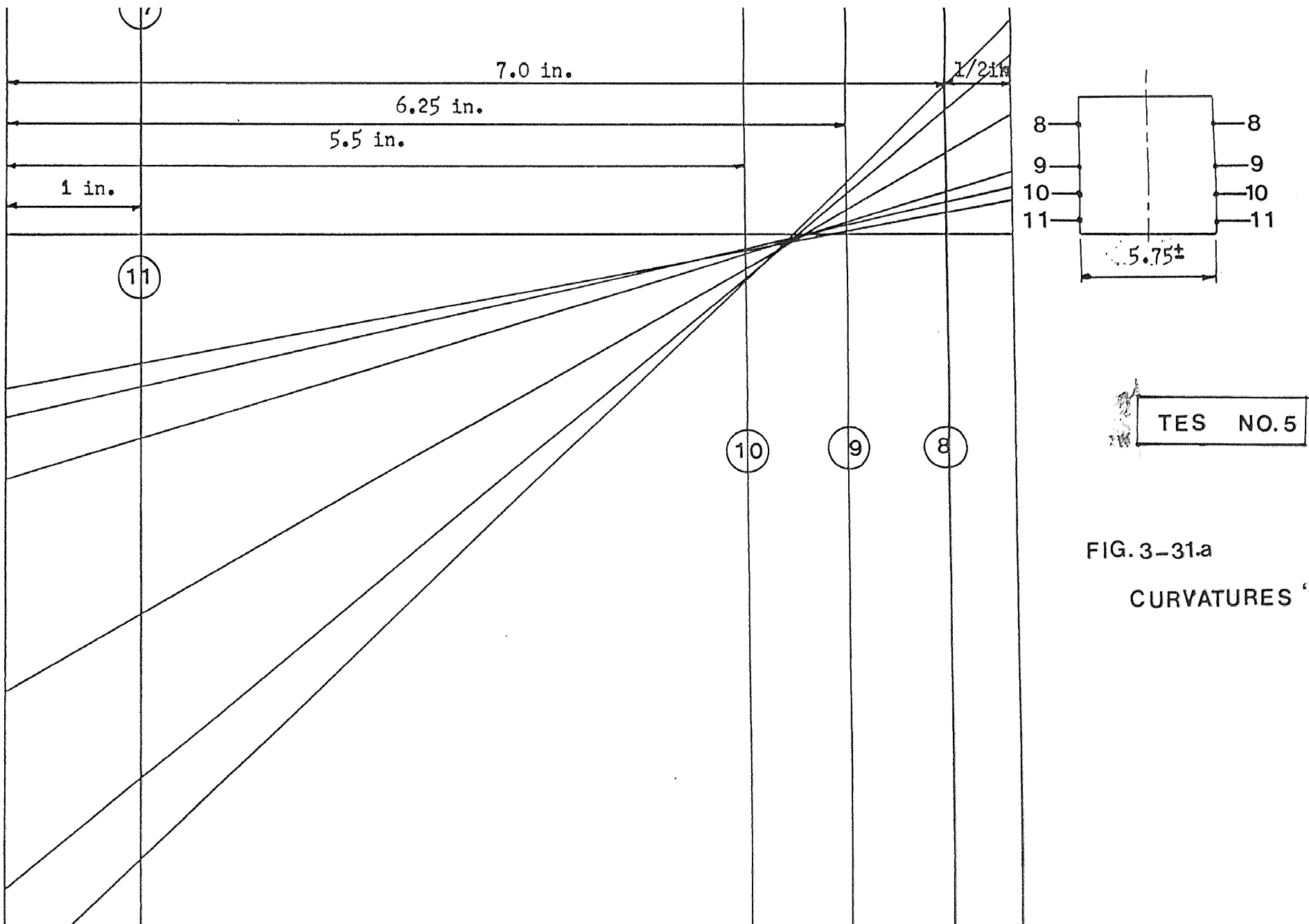
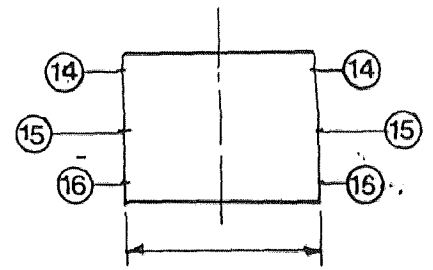
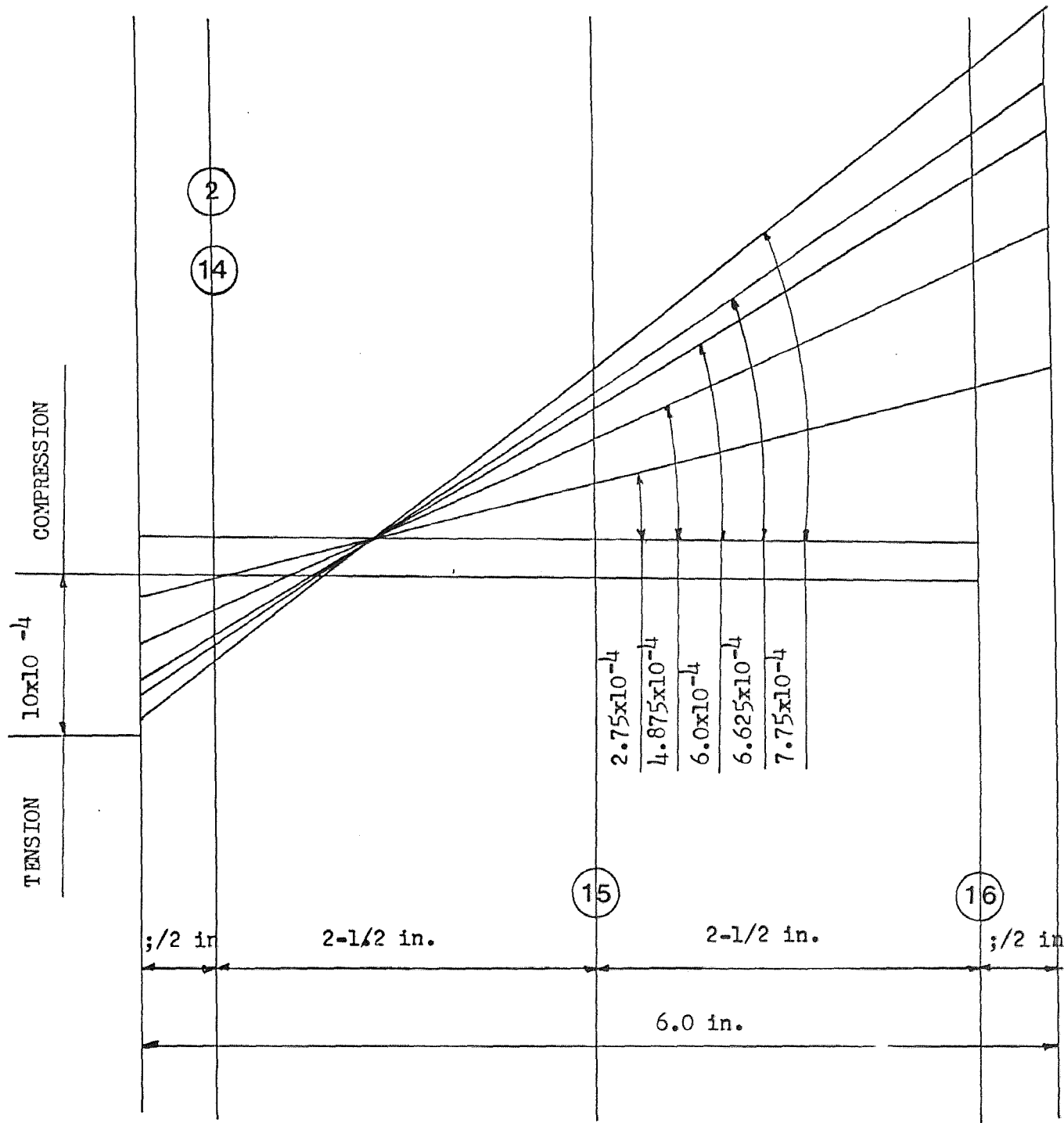

FIG. 3-31.a

CURVATURES 'Y'



TEST NO. 4

FIG. 3-32
CURVATURE 'X'

FIG. 3-3 2.a

CURVATURE 'Y'

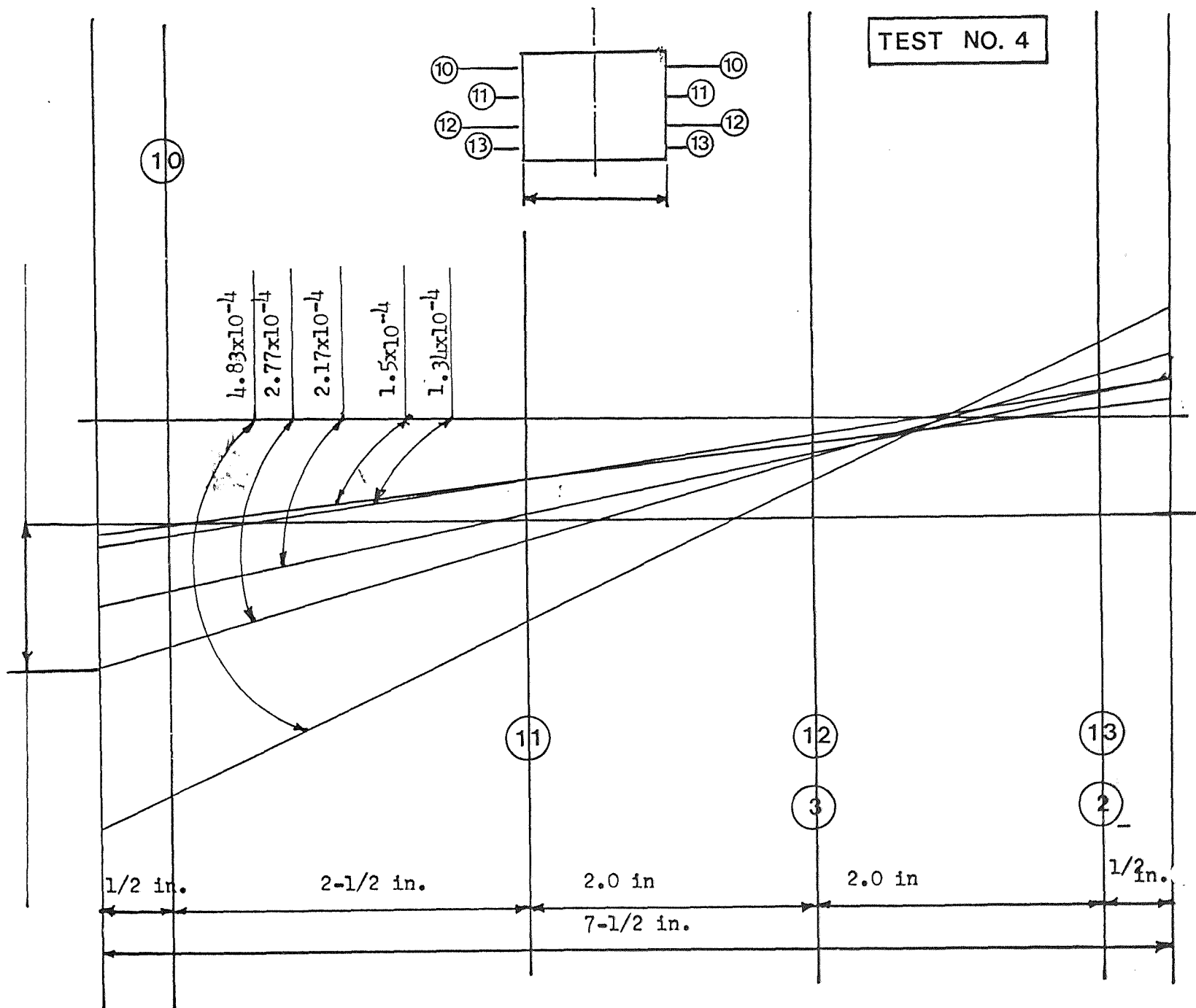

FIG. 3.33 MOMENT-CURVATURE DIAGRAM

TEST NO. 5

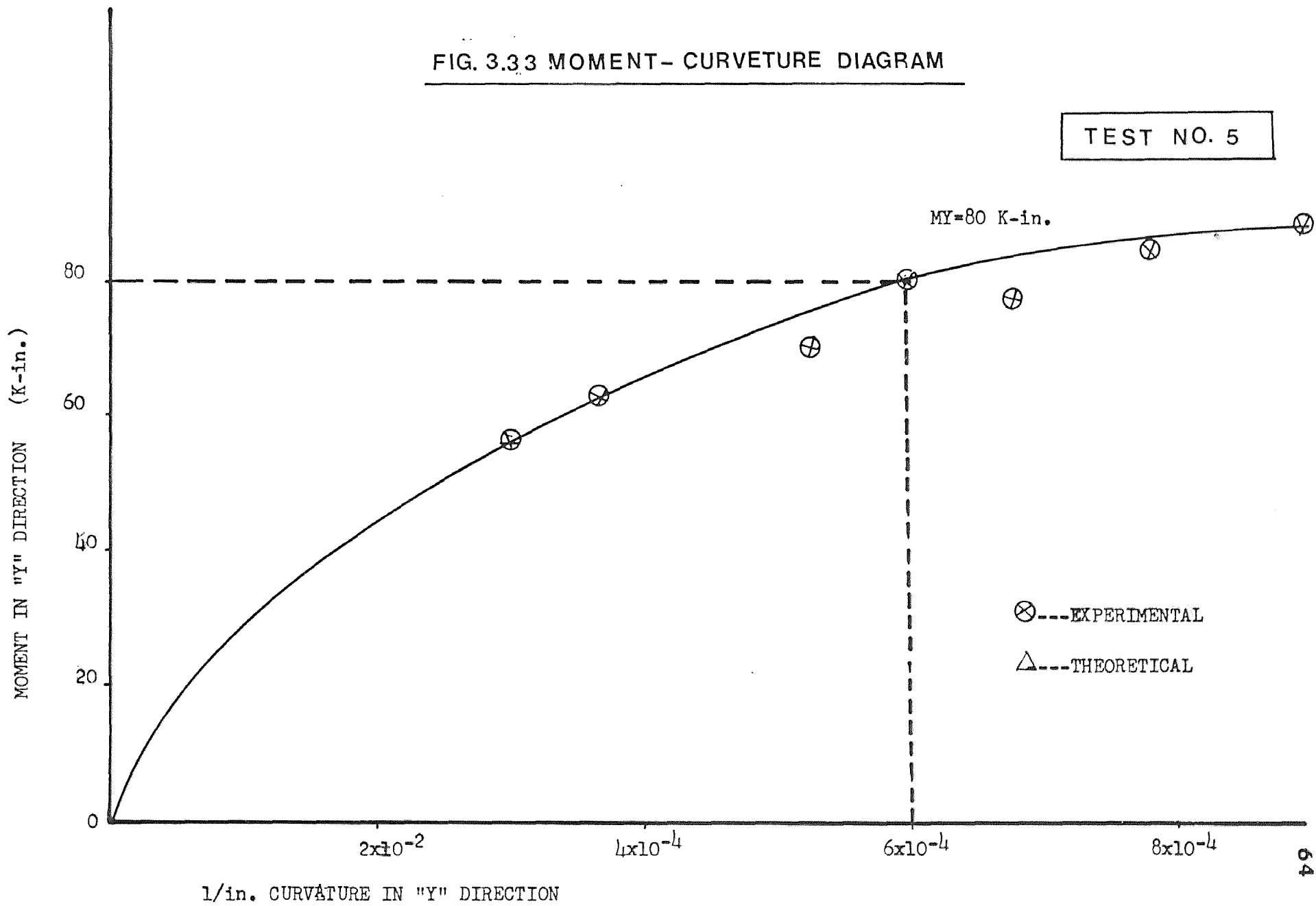

FIG. 3-34 MOMENT- CURVATURE DIAGRAM

TEST NO. 5

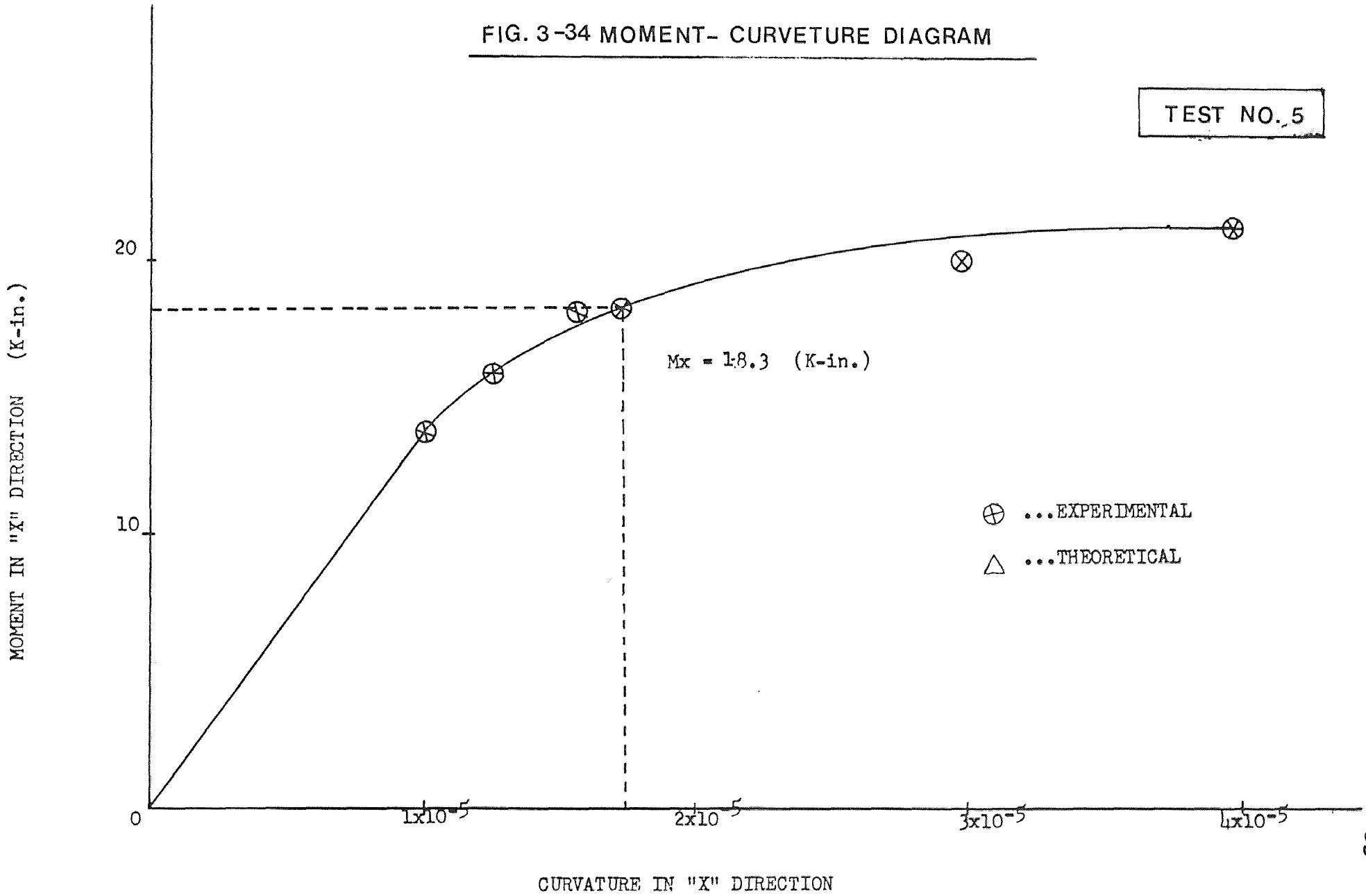

FIG. 3-35 MOMENT-CURVATURE DIAGRAM

TEST NO. 4

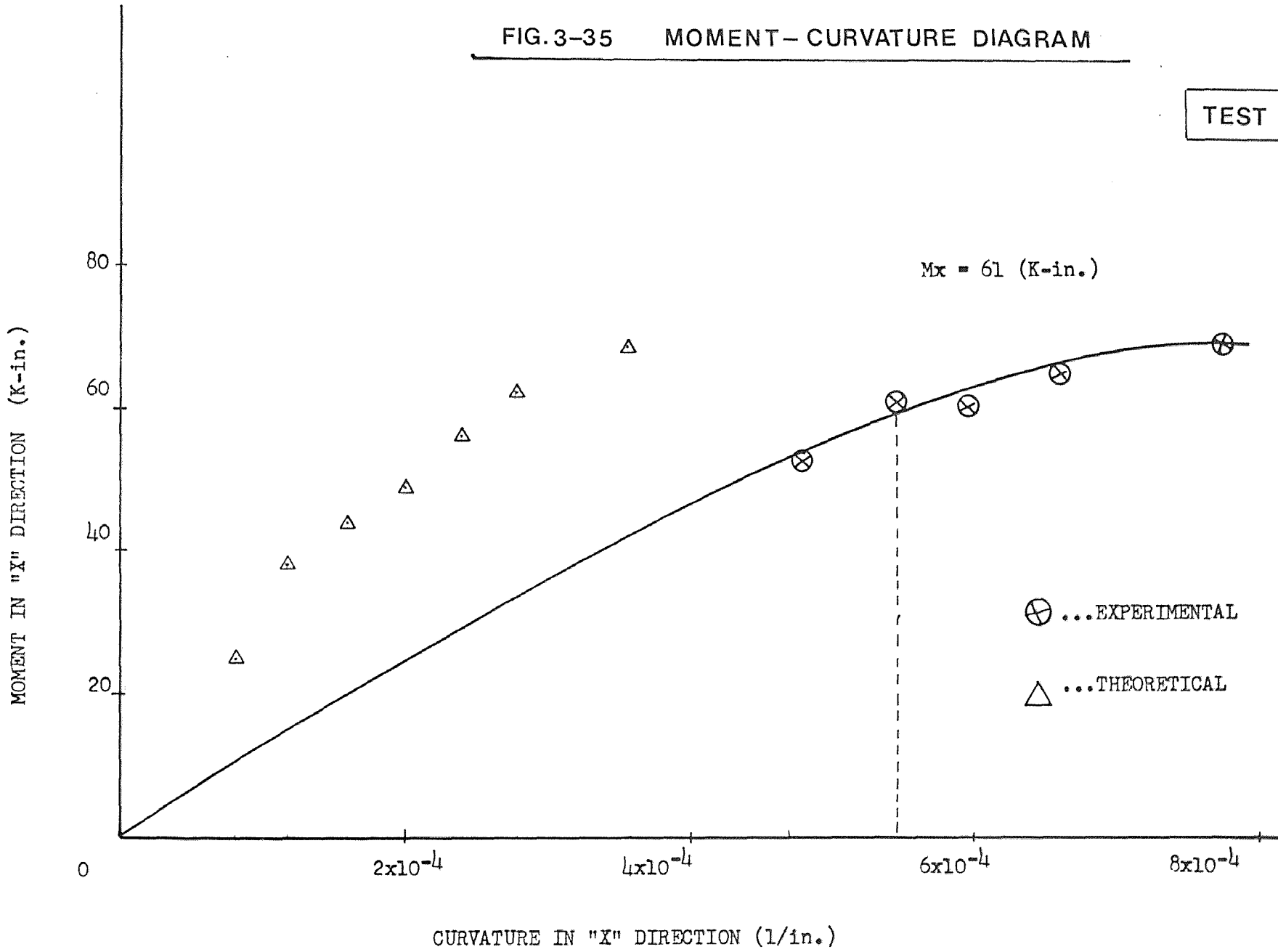
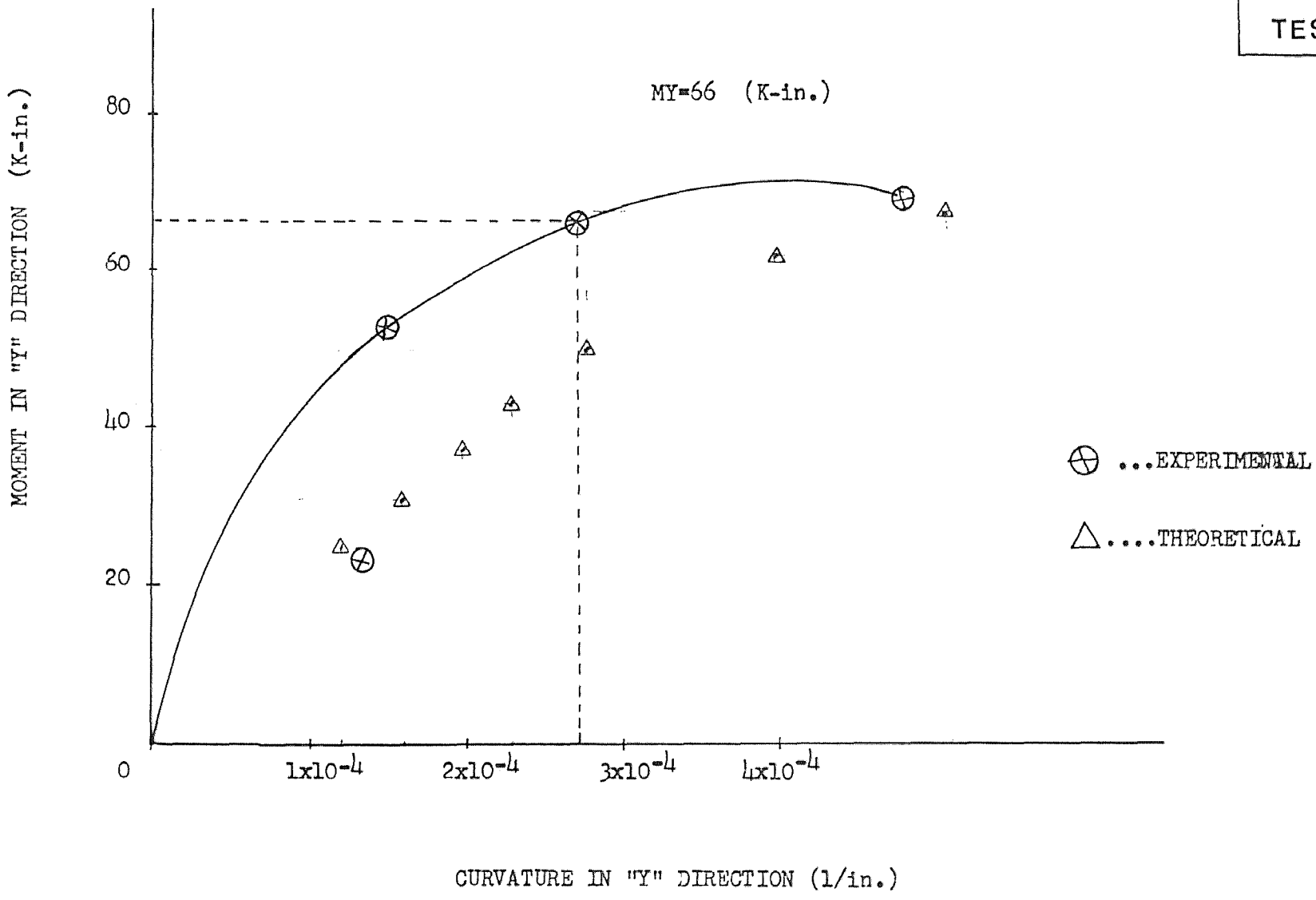

FIG.3-36 MOMENT - CURVATURE DIAGRAM

TEST NO. 4



Namely tension failure, compression failure and balanced failure. Tension failure characterized by large deformations accompanied with the yielding of the tension steel and considerable movement of the neutral axis prior to crushing of the concrete.

In compression failures, concrete starts crushing and spalling before the farthest tension reinforcing bar reaches its yield strength in balance failure concrete starts crushing and spalling at the same time as the farthest reinforcing bar in tension reaches yield stress.

Crack patterns for biaxially loaded column specimens after test can be found in Figure 3.26 through 3.34

Generally, there are two kinds of concrete crushing and spalling observed in tests. If the eccentricity e_x is equal to or close to the eccentricity e_y , the typical failure is as shown in Figure 3.33 (First specimen from left). Also for large eccentricities a large magnitude of concrete crushing and spalling was found in compression side of column (See Figure 3.42 and Figure 3.43).



Figure 3.37 - CRACK PATTERNS

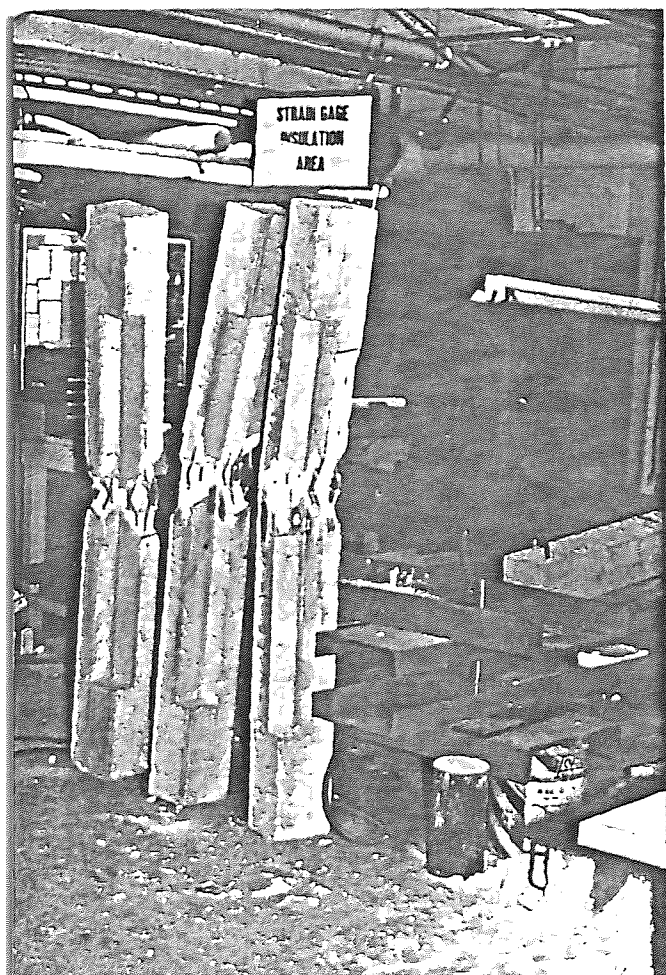

Figure 3.38 - CRACK PATTERNS

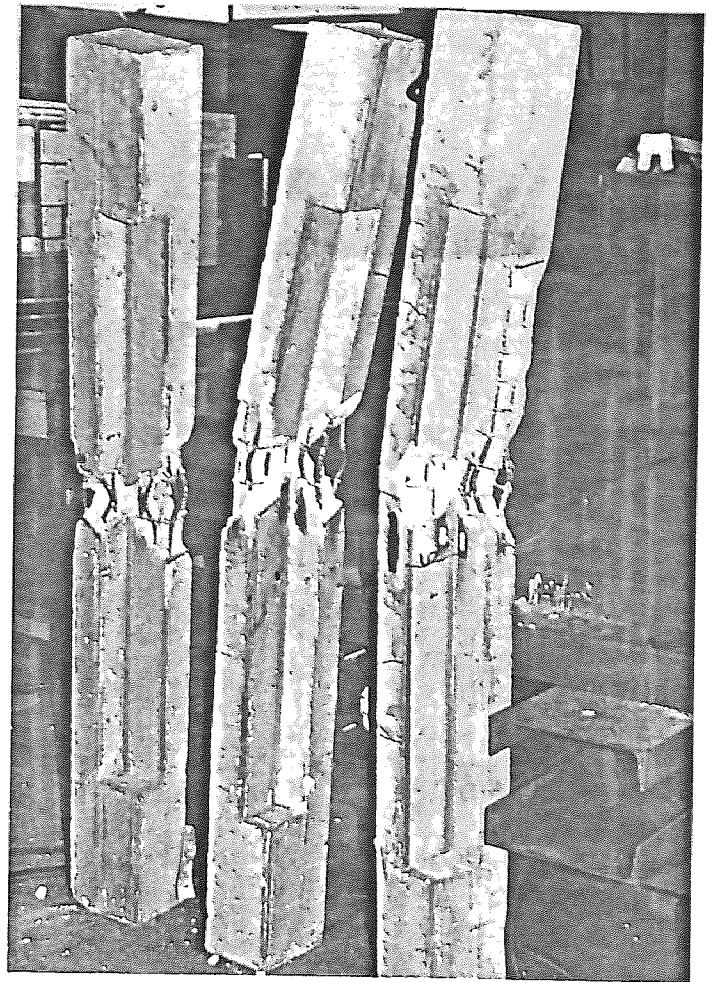

Figure 3.39 - CRACK PATTERNS

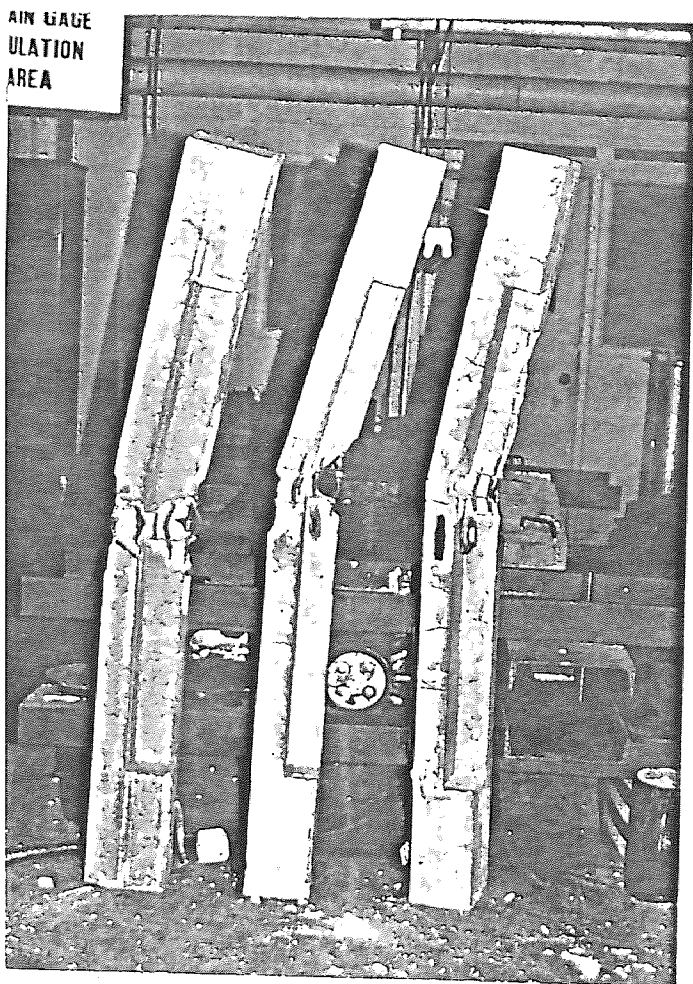

Figure 3.40 - CRACK PATTERNS

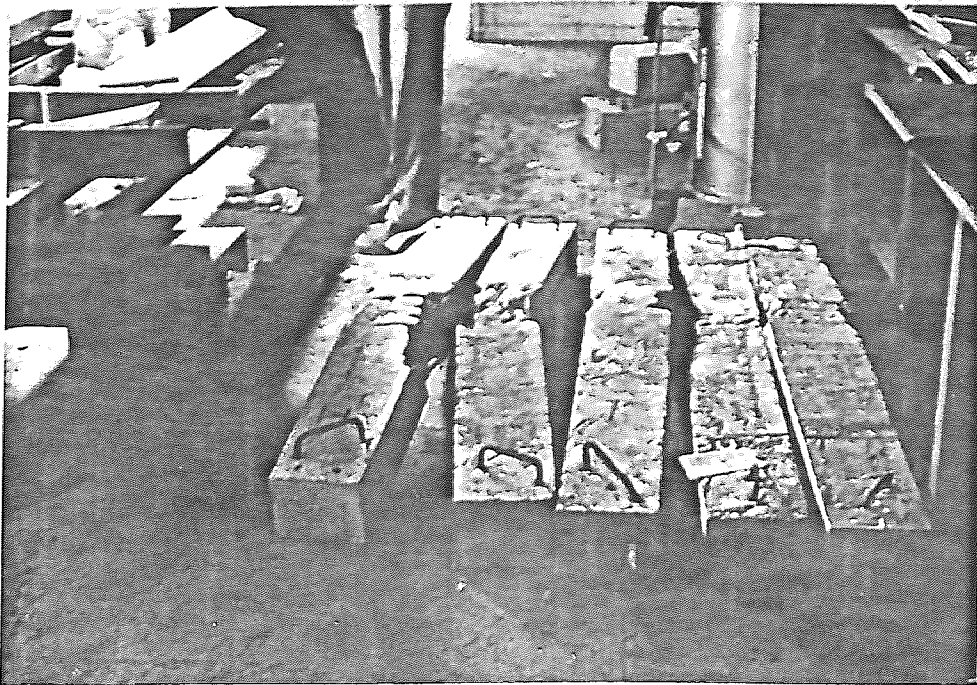

Figure 3.41 - CRACK PATTERNS

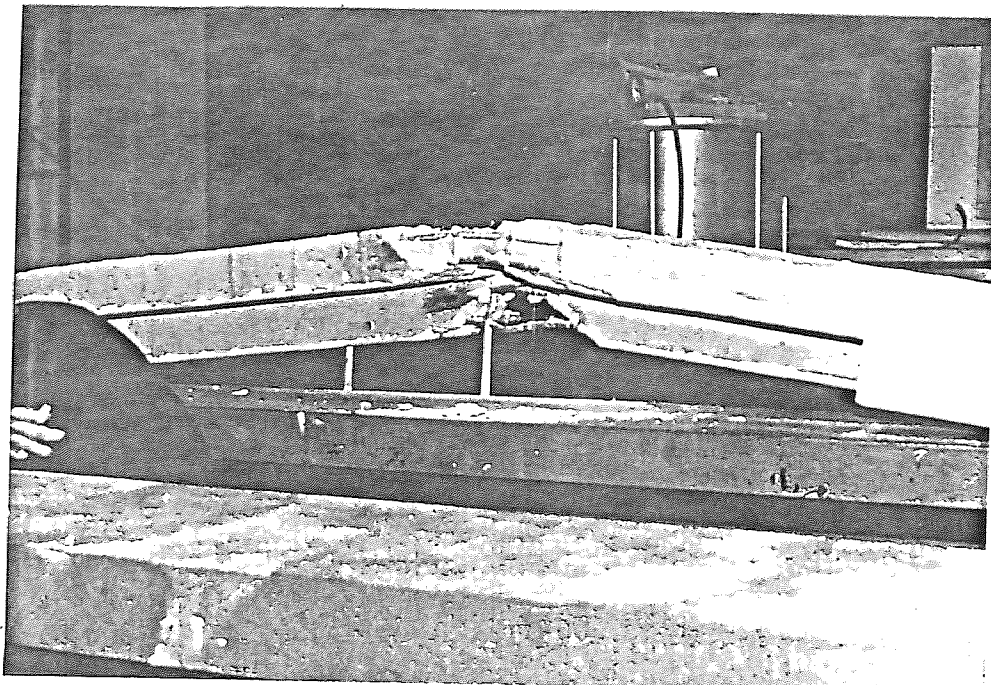

Figure 3.42 - CRACK PATTERNS

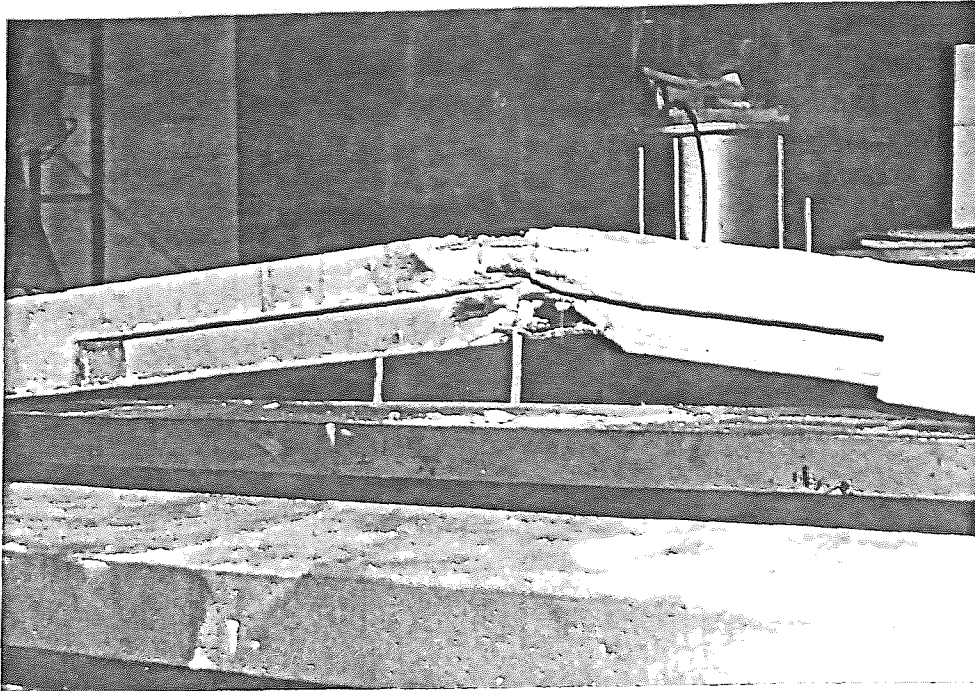

Figure 3.43 - CRACK PATTERNS



Figure 3.44 - CRACK PATTERNS



Figure 3.45 - CRACK PATTERNS

NON-LINEAR BEHAVIOR AND CHARACTERISTICS
OF L-SHAPED REINFORCE CONCRETE COLUMN UNDER
BIAXIAL BENDING AND COMPRESSION

CHAPTER IV

4.1 Introduction

This chapter presents a method for the determination of strain and curvature distributions in reinforced concrete column subjected to biaxial bending moments and axial load. A closed form solution which accounts for the inelasticity of concrete, the elastic, plastic and strain-hardening behavior of steel reinforcement and the geometrical complexities in the section, etc., is time consuming and impractical.

The computer program developed by Hsu (1,5,6) has the ability to use any standard reinforced and prestressed concrete section geometry and material properties. This computer program also gives information for stress and strain distributions across the section, the ultimate strength and interaction surface for biaxially loaded short columns, and, and also develop the flexural rigidity coefficients for members of a three dimensional structural concrete frame for both the elastic and inelastic loading stages and can be incorporated without much difficulties in the existing Gere and Weaver⁽⁹⁾ Harrison⁽¹⁰⁾, Morris and Fenves^(11, 12), Beaufait et al⁽¹³⁾

All these programs can calculate the load-deformation curves from zero to maximum moment capacity using a "Load Control" process in the case of combined biaxial bending and axial compression for the case of moment-deformation characteristics under constant axial load, the "Deformation Control" process -as used by Hsu ⁽⁵⁾.

4.2 Biaxial Moment-Curvature Relationships

Very little information is available on the behavior of reinforced concrete columns under combined bending and axial compression. Few investigators have studied the biaxial moment-curvature relationships under constant biaxial compression, among them Hsu ⁽⁵⁾, and Warner ⁽¹⁵⁾.

Cranston ⁽¹⁴⁾ suggested a numerical method in which biaxial moment curvature relationships under constant axial force can be obtained from zero load to the maximum moment capacity. Also Warner ⁽¹⁵⁾ proposed another approach for the moment-curvature relationship under constant axial compression. Warner's method can not be applied in three dimensional structural analysis because he assumed that θ (inclination of the curvature vector to one of the neutral principal axis which is related to the angle position of the neutral axis in section) is given which is impossible to know in these studies. However, Hsu developed the program which eliminates this problem. This program gives information such as:

- A. Stress and strain distributions across the section.
- B. Ultimate strength and interaction surface of biaxially loaded short column either compression or tension.
- C. Load-deformation curves from zero to maximum moment capacity.
- D. Moment-curvature curves from zero to maximum moment capacity.

4.2 Basic Assumptions

The following assumptions have been made in the theoretical analysis by Hsu ⁽¹⁾:

- (1) The bending moments are applied about the principal axes
- (2) Plane section remain plane, before and after bending.
- (3) The longitudinal stress at a point is a function only of the longitudinal strain at that point. The effect of creep and shrinkage are ignored.
- (4) The stress strain curves for the materials used are known.
- (5) Strain reversal does not occur.
- (6) The effect of deformation due to shear and tension and impact effects are negligible.
- (7) The section does not buckle before the ultimate load is attained.
- (8) Perfect bond exists between the concrete and reinforcing steel.

4.3 Computer Approach

The general moment-curvature or load deflection relationships are shown in Figure 4.1, which indicate that close to peak of the load-deflection curve there can be two equilibrium positions corresponding to the same loads. (Bleich ⁽¹⁶⁾ and Cranstone ⁽¹⁷⁾). To avoid difficulties in this region it is convenient to find solutions corresponding to the specified deflections. Yet in the initial stages, from zero to the maximum load, it is simpler to find solution corresponding to specified loads.

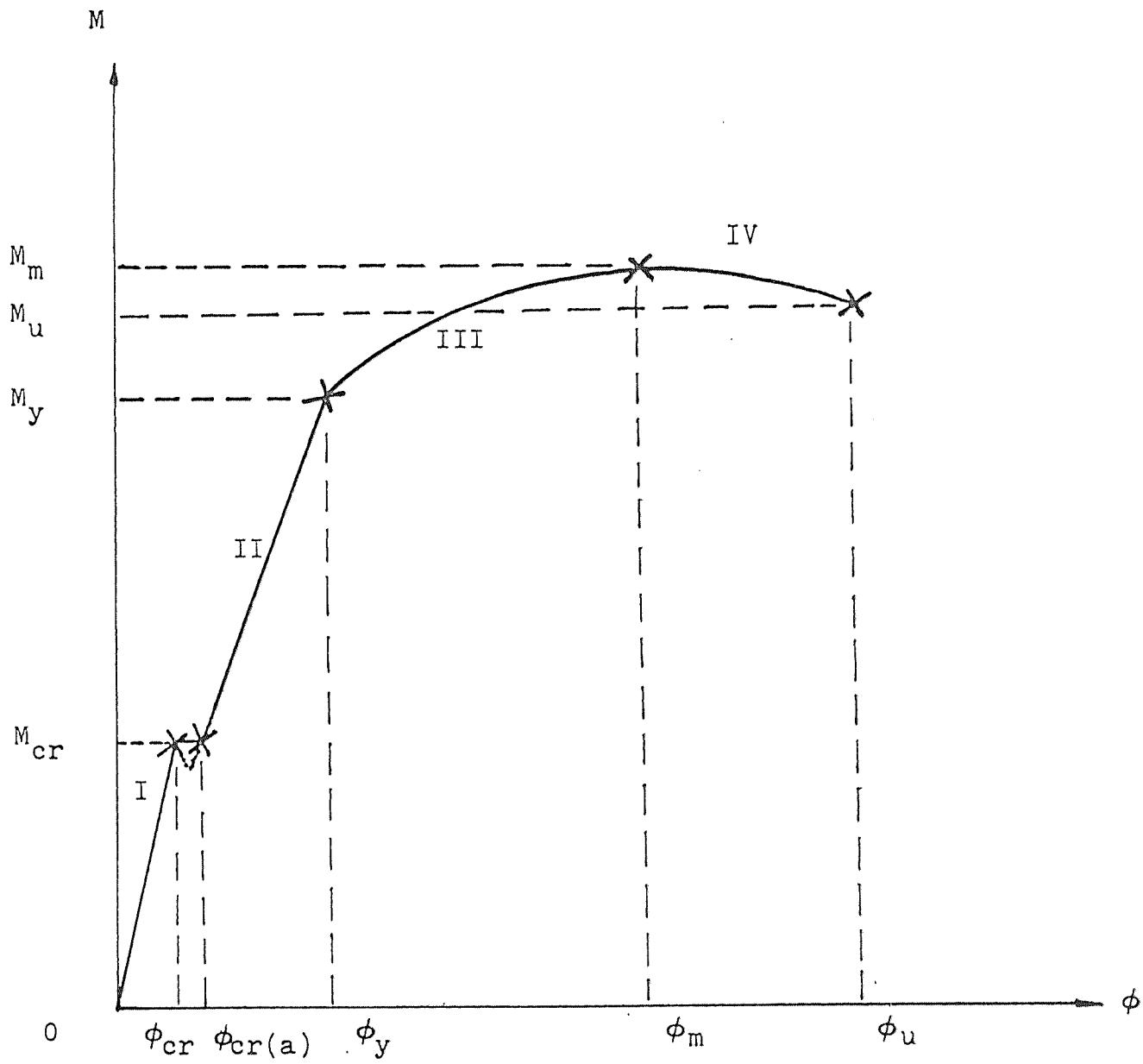

FIG. 4.1 TYPICAL MOMENT-CURVATURE CURVE

The cross section of the column was divided into one hundred-twenty six elements (Figure 4.2.. The areas and 'x', 'y' coordinates are tabulated in Table 4.1, which were used as input data for computer.

4.4 Ultimate Strength Interaction Surface for Members Subjected to Biaxial Bending and Axial Compression

The three dimensional ultimate strength interaction surfaces for short columns subjected to axial compression and biaxial bending have been studied for decades. The strength of a section under axial load and bending defined by three parameters (5): The axial load and the two component of the bending moment. If these parameters are represented in a spatiac orthogonal coordinate system, where the vertical axis represents the axial load and the two horizontal axis the two components of the bending moments, the strength of the section may be represented by an interaction surface, as shown in figure 4.3.

The strength of a section at a given axial load can be obtained by intersecting the interaction surface by a plane parallel to the bending moment axes at the given axial load, which permits the representation of the bending moment capacity of the section in a plane. Figure 4.4 shows a tri-dimensional model of the interaction surface for an "L" shaped reinforced concrete column.

It should be noted that if the spatial coordinate system is referred to the centeroid of the concrete cross section and reinforcement is not symmetrical with respect to the cross section centroid, then the poles of interaction surface (Compression under tension with no bending moment with respect to the plastic centroid) will not be located in the axial load axis.

31	30	29	28	27	26	25	24	23	22	21	20
32	5	72	71	4	70	69	3	68	67	2	19
33	73	101	100	99	98	97	96	95	94	66	18
34	74	102	121	122	123	124	125	126	93	65	17
35	6	103	120	13	89	90	14	91	92	1	16
36	75	104	119	88	59	60	61	62	63	64	15
37	76	105	118	C.G. 87	58						
38	7	106	117	12	57						
39	77	107	116	86	56						
40	78	108	115	85	55						
41	8	109	114	11	54						
42	79	110	113	84	53						
43	80	111	112	83	52						
44	9	81	82	10	51						
45	46	47	48	49	50						

Figure 4.2

<u>Area No.</u>	<u>Area in. ²</u>	<u>X in.</u>	<u>Y in.</u>
1	.11	2.893	0.857
2	.11	2.893	2.357
3	.11	1.393	2.357
4	.11	-0.107	2.357
5	.11	-1.607	2.357
6	.11	-1.607	0.857
7	.11	-1.607	-0.643
8	.11	-1.607	-2.143
9	.11	-1.607	-3.643
10	.11	-0.107	-3.643
11	.11	-0.107	-2.143
12	.11	-0.107	-0.643
13	.11	-0.107	0.857
14	.11	1.393	0.857
15	0.316	3.362	0.388
16	.211	3.362	0.857
17	.316	3.362	1.326
18	.316	3.362	1.888
19	.211	3.362	2.357
20	.316	3.362	2.826
21	.211	2.893	2.826
22	.316	2.424	2.826
23	.316	1.862	2.826
24	.211	1.393	2.826
25	.316	0.925	2.826
26	.316	0.362	2.826
27	.211	-0.107	2.826
28	.316	-0.576	2.826
29	.316	-1.138	2.286
30	.211	-1.607	2.826

TABLE 4-1

<u>Area No.</u>	<u>Area in. ²</u>	<u>X in.</u>	<u>Y in.</u>
31	.316	-2.076	2.826
32	.211	-2.076	2.357
33	.316	-2.076	1.888
34	.316	-2.076	1.326
35	.211	-2.076	0.857
36	.316	-2.076	0.388
37	.316	-2.076	-1.174
38	.211	-2.076	-0.643
39	.316	-2.076	-1.112
40	.316	-2.076	-1.674
41	.211	-2.076	-2.148
42	.316	-2.076	-2.612
43	.316	-2.076	-3.174
44	.211	-2.076	-3.643
45	.316	-2.076	-4.112
46	.211	-1.607	-4.112
47	.316	-1.138	-4.112
48	.316	-0.576	-4.112
49	0.211	-0.107	-4.112
50	0.316	0.362	-4.112
51	0.211	0.362	-3.643
52	0.316	0.362	-3.174
53	0.316	0.362	-2.612
54	0.211	0.362	-2.143
55	0.316	0.362	-1.674
56	0.316	0.362	-1.112
57	0.211	0.362	-0.643
58	0.316	0.362	-0.174
59	0.316	0.362	.388
60	0.316	0.925	.388

TABLE 4-1

<u>Area No.</u>	<u>Area in. ²</u>	<u>X in.</u>	<u>Y in.</u>
61	0.211	1.393	.388
62	0.316	1.862	.388
63	0.316	2.424	.388
64	.211	2.893	.388
65	.211	2.893	1.326
66	.211	2.893	1.888
67	.211	2.424	2.357
68	.211	1.862	2.357
69	.211	0.925	2.357
70	.211	0.362	2.357
71	.211	-0.576	2.357
72	.211	-1.138	2.357
73	.211	-1.607	1.888
74	.211	-1.607	1.326
75	.211	-1.607	.388
76	.211	-1.607	-0.174
77	.211	-1.607	-1.112
78	.211	-1.607	-1.674
79	.211	-1.607	-2.612
80	.211	-1.607	-3.174
81	.211	-1.138	-3.643
82	.211	-0.576	-3.643
83	.211	-0.107	-3.174
84	.211	-0.107	-2.612
85	.211	-0.107	-1.674
86	.211	-0.107	-1.112
87	.211	-0.107	-0.174
88	.211	-0.107	.388
89	.211	0.362	.857
90	.211	0.925	.857

TABLE 4-1

<u>Area No.</u>	<u>Area in. ²</u>	<u>X in.</u>	<u>Y in.</u>
91	.211	1.862	.857
92	.211	2.424	.857
93	.316	2.424	1.326
94	.316	2.424	1.888
95	.316	1.862	1.888
96	.211	1.393	1.888
97	.316	0.925	1.888
98	.316	0.362	1.888
99	.211	-0.107	1.888
100	.316	-0.576	1.888
101	.316	-1.138	1.888
102	.316	-1.138	1.326
103	.211	-1.138	.857
104	.316	-1.138	.388
105	.316	-1.138	-0.174
106	.211	-1.138	-0.643
107	.316	-1.138	-1.112
108	.316	-1.138	-1.674
109	.211	-1.138	-2.143
110	.316	-1.138	-2.612
111	.316	-1.138	-3.174
112	.316	-0.576	-3.174
113	.316	-0.576	-2.612
114	.211	-0.576	-2.143
115	.316	-0.576	-1.674
116	.316	-0.576	-1.112
117	.211	-0.576	-0.643
118	.316	-0.576	-0.174
119	.316	-0.576	.388
120	.211	-0.576	.857

TABLE 4-1

<u>Area No.</u>	<u>Area in.²</u>	<u>X in.</u>	<u>Y in.</u>
121	.316	-0.576	1.326
122	.211	-0.107	1.326
123	.316	0.362	1.326
124	.316	0.925	1.326
125	.211	1.393	1.326
126	.316	1.862	1.326

TABLE 4-1

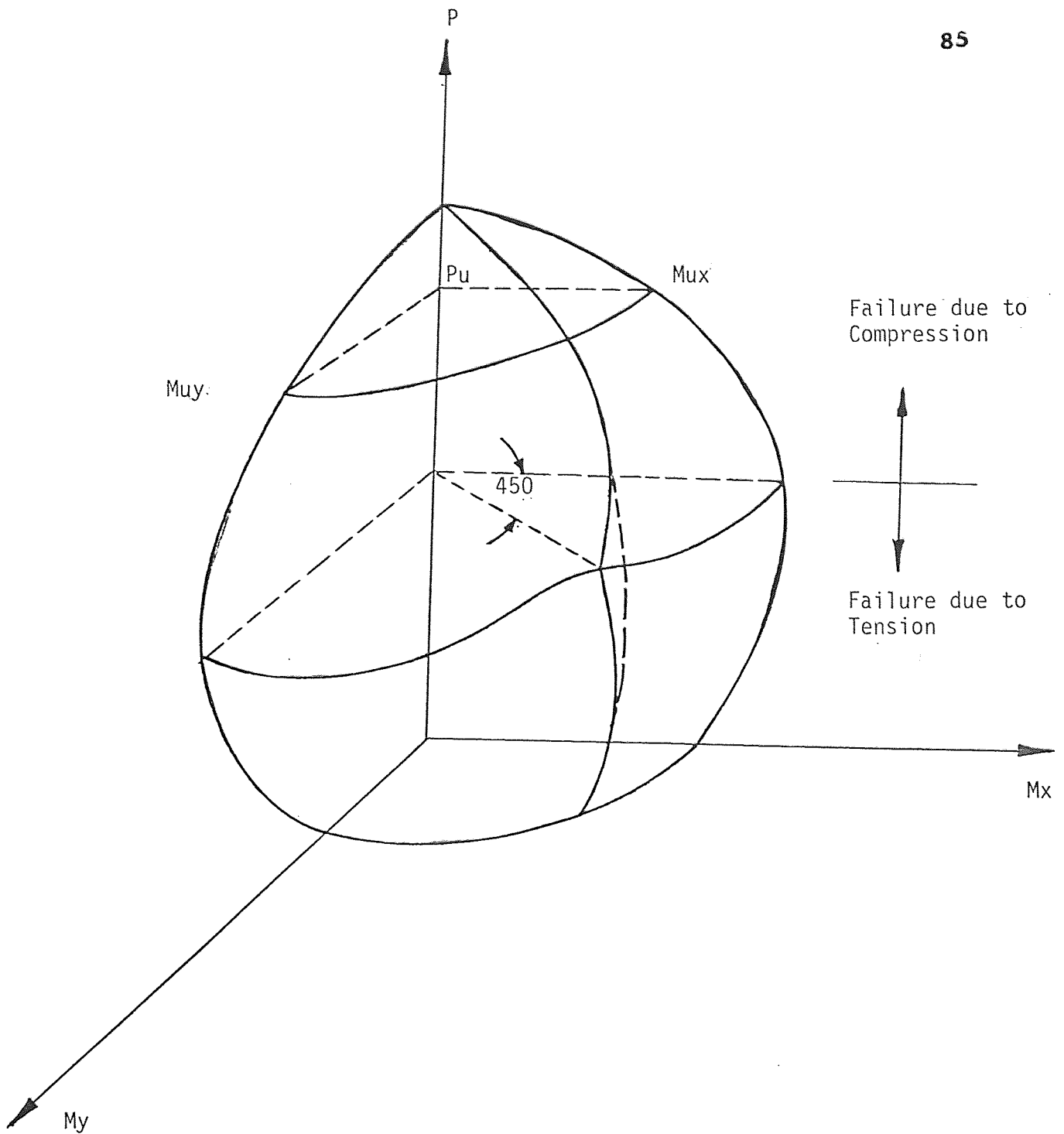

Figure 4.3 Interaction Surface for Column Member Subjected to Biaxial Bending and Compression (After Pannell)

Marin (18) has developed a collection of 50 Isoload charts for five different types of "L" shaped reinforced concrete short column. Figure 4.5 shows a typical isoload design chart. These charts are similar in shape to the charts developed by Chen and Atsuta (19) for steel angles. The above interaction diagrams are very useful for the practical design task. However, no one has conducted experimental tests to prove that their analytical data are valid.

4.5 Biaxial Moment-Curvature Curves:

Based on the above computer program developed by Hsu (1,5). The theoretical biaxial Moment-Curvature curves are plotted from the computer output. They are shown in Figures 3-35 and 3-36. It can be seen that the theoretical results are in good agreement with the experimental results being conducted in the present investigation. However, the experimental moment values underestimate those of the theoretical values because the central deflections of the specimen were ignored in computing the moment values. Otherwise, the moment-curvature results will be in much better agreement than the ones shown in Figures 3-35 and 3-36. More extensive research should be conducted in this area.

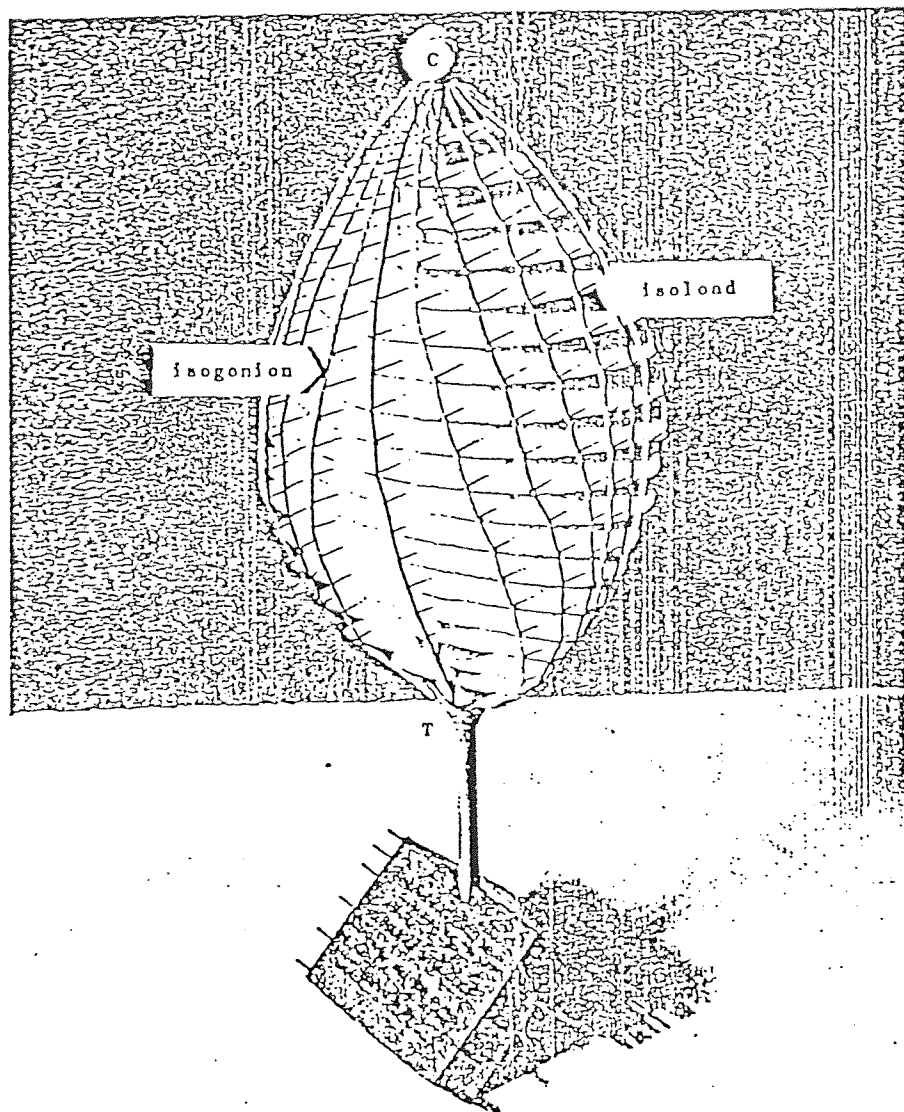

Figure 4.4 Tri-dimensional model of the interaction surface of an "L" section. (Ref. #6)

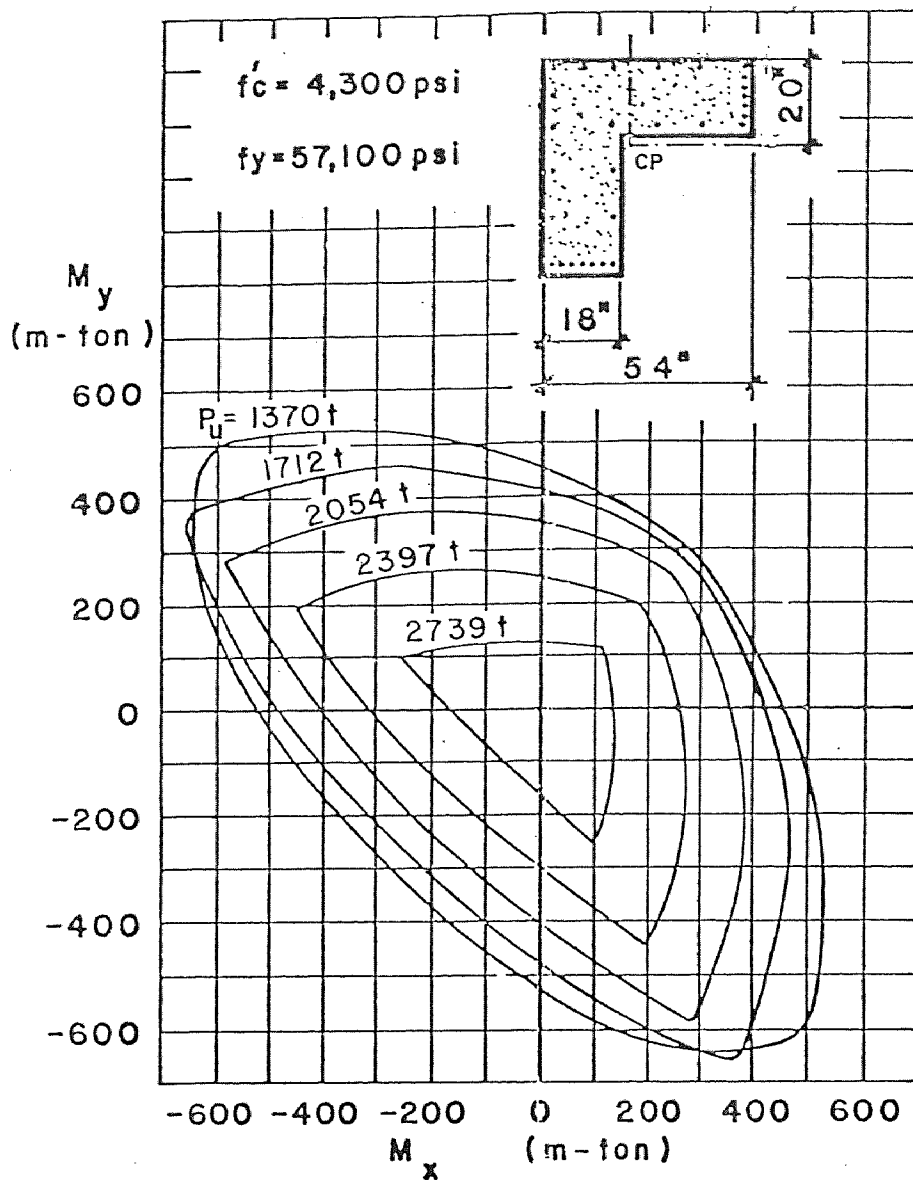

FIG. 4.5 ISOLOAD DIAGRAM FOR
"L" CROSS SECTION

(Ref. #6)

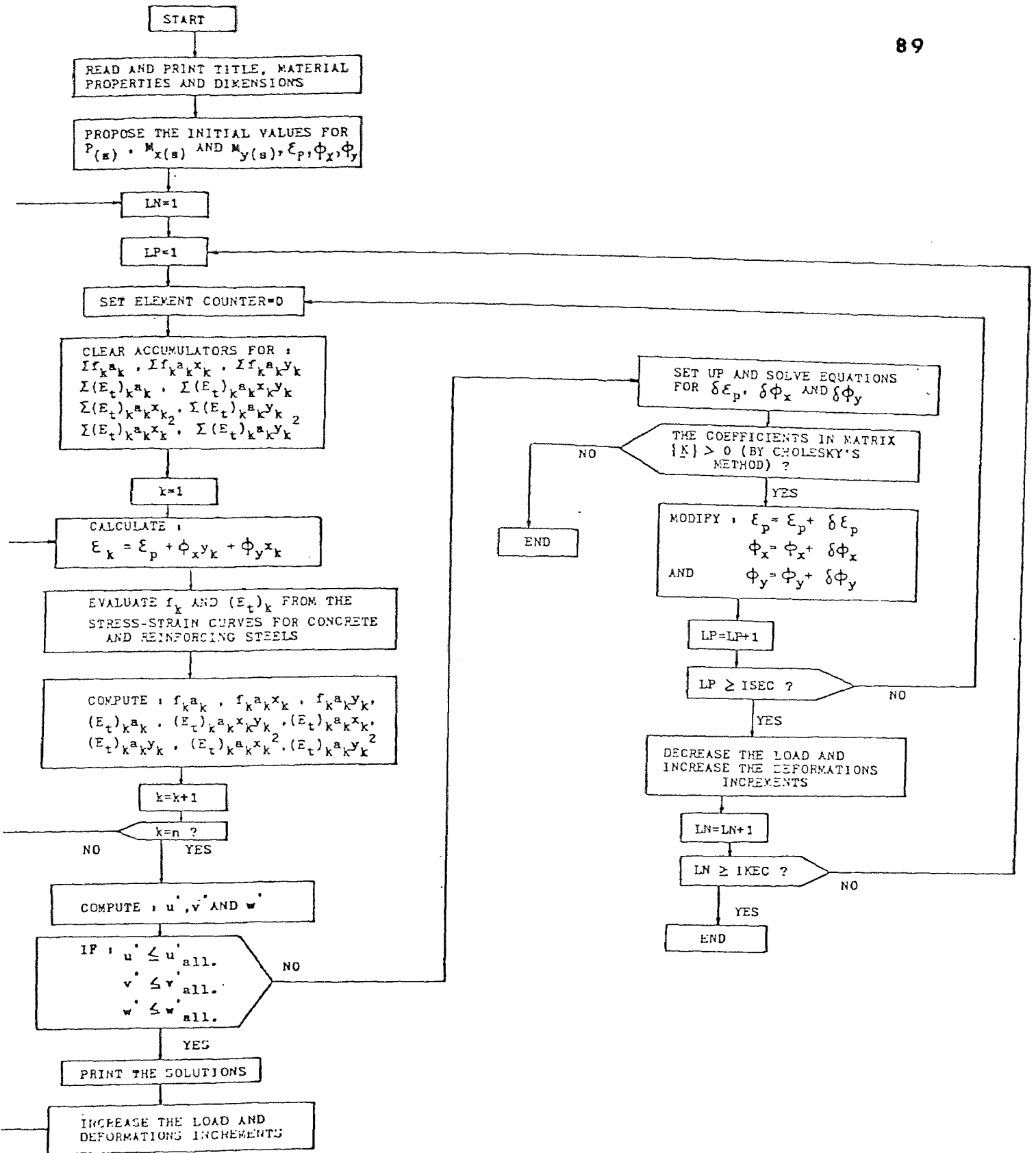

FIG. 4.6 FLOW DIAGRAM : COMPUTER PROGRAM FOR MOMENT-CURVATURE RELATIONSHIP UNDER COMBINED BIAxIAL BENDING AND AXIAL LOAD (Refer to Ref. #5)

SUMMARY AND CONCLUSIONS

CHAPTER V

An analytical model is presented to simulate the load-deformation behavior of reinforced concrete elements subjected to axial compression and/or biaxial bending. Based on the control of load increments, the algorithm enables determination of moment-curvature relationship for a reinforced concrete member with any geometry and material properties up to the maximum moment capacity of the section; this information can be used to calculate the load-deformation curves using a suitable deflection control, this computer program can be modified to compute both the ascending and the descending branches of the moment-curvature and the resulting load-deformation curve.

Good agreement obtained between experimental strengths and the failure modes obtained from tests and analytical results calculated using the computer program. The experimental strain and curvature data obtained from tests were noted to be in good agreement with the analytical results through all load stages from zero load up to the maximum moment capacity of the section.

The shape of failure surface for a square or circular section is different from that of a "L" section. It is recommended that further similar studies be conducted for deviation or failure surfaces. The existing computer program can be used for the development of the failure surfaces against the physical test data, and also can be used to predict the percentage of deviation with different percentages of reinforcements or shapes or section.

BIBLIOGRAPHY

1. Hsu, C.T. and Mirza, M.S., "Structural Concrete-Biaxial Bending and Compression", Journal of the Structural Division ACE, Vol. 99, No. ST. 2, February 1973 P. 285.
2. Anderson, P. and Lee, H.N. "A Modified Plastic Theory of Reinforced Concrete". Bulletin No. 33, University of Minnesota, Vol. Liv, No. 19, April 1951.
3. Meek, J.L., "Ultimate Strength of Columns with Biaxially Eccentric Loads", Proceedings, ACI, Vol. 60 PT 2, 1963.
4. Bresler, B. "Design Criteria for Reinforced Concrete Columns", Proceedings, ASCE, Vol. 84, ST. 8, December 1958, P. 1865.
5. Hsu, C.T. "Behavior of Structural Concrete Subjected to Biaxial Flexure and Compression" PH D. Thesis McGill University, August 1974.
6. Hsu, C.T. and Mirza, M.S., "A Numerical Analysis of Reinforced and Prestressed Concrete Section Under Combined Flexure and Axial Compression", Structural Concrete Series No. 72-1, McGill University, February 1972.
7. Hsu, C.T. and Mirza, M.S., "Structural Concrete - Biaxial Bending and Compression", Journal of the Structural Division ACE, Vol. 99, No. ST. 2, February 1973 P. 285.
8. Drysdale, R.C. "The Behavior of Slender Reinforced Concrete Columns Subjected to Sustained Biaxial Bending", Ph. D. Thesis, University of Toronto, September 1967.

9. Gere, J.M. and Weaver, W. Jr., "Analysis of Framed Structures", D. Van Nostrand Company, Inc. Princeton, New Jersey, 1965.
10. Harrison, H.S., "Computer Method in Structural Analysis", Prentice-Hall, Inc., Englewood Cliffs, New Jersey, 1973.
11. Morris, G.A. and Fenves, S.J., Elastic and Plastic Analysis of Framework", S.R.S. No. 305, Department of Civil Engineering, University of Illinois, August 1967.
12. Morris, G.A. and Fenvas, S.J. Elastic and Plastic Analysis of Framework", Journal of Structural Division, ASCE, Vol. 96, ST. 5^o May, 1970.
13. Beaufait, F.W., Rowan, W.H. Jr., Hoadley, P.G. and Hackett, R.M., "Computer Method of Structural Analysis", Prentice-Hall, Inc. Englewood Cliffs, New Jersey 1970.
14. Cranston, W.B., "Determining the Relation Between Moment, Axial Load and Curvature for Structural Members", Technical Report Tra. 395, Cement and Concrete Association, London, June, 1966.
15. Warner, R.F., "Biaxial Moment Thrust Curvature Relations", Journal of the Structural Division, ASCE, Vol. 95, No. ST 5, May, 1969.
16. Belèich, H.H., "Buckling Strength of Metal Structures", McGraw-Hill Book Company, 1952.
17. Cranston, W.B., "A Computer Method for the Analysis of Restrained Columns, TRA. 402, April, 1967, Cement and Concrete Association, London.
18. Chen, W.F., Atsuata, T., "Theory of Beam Columns", McGraw-Hill 1977, Volumn 2.